

Preliminary Datasheet

1.0A Opto-Compatible Single Channel Isolated Gate Driver

1 GENERAL DESCRIPTION

The SLM345 is an opto-compatible, single channel, isolated gate driver for IGBTs, MOSFETs with 1.0A source and 1.0A sink peak output current and 5kV_{RMS} reinforced isolation rating. SLM345 can drive both low side and high side power FETs. Key features and characteristics bring significant performance and reliability upgrades over standard optocoupler based gate drivers while maintaining pin-to-pin compatibility in both schematic and layout design. Performance highlights include high common mode transient immunity (CMTI), low propagation delay, and small pulse width distortion.

The input stage is an emulated diode which means long term reliability and excellent aging characteristics compared to traditional LEDs. It is offered in a stretched SO6 package with >8.5mm creepage and clearance. A mold compound from material group I which has a comparative tracking index (CTI) >600V. SLM345's high performance and reliability makes it ideal for use in all types of motor drives, solar inverters, industrial power supplies, and appliances.

2 FEATURES

- 1.0A maximum source output current
- 1.0A maximum sink output current
- 140ns (Max.) propagation delay
- 25ns (Max.) part-to-part delay matching
- 35ns (Max.) pulse width distortion
- 150kV/us (Min.) common mode transient immunity (CMTI)
- Gate drive supply range from 10 V to 40 V
- 30V reverse polarity voltage handling capability on input stage
- Pin to pin compatible to optocoupler isolated gate drivers
- Stretched SO-6 package with >8.5mm creepage and clearance
- Junction temperature, T_J: -40°C to +150°C
- Safety certifications (Planned):
 - 5kV_{RMS} isolation for 1 minute per UL 1577
 - DIN V VDE 0884-11

3 APPLICATION

- AC and brushless DC motor drives
- Renewable energy inverters
- Industrial power supplies

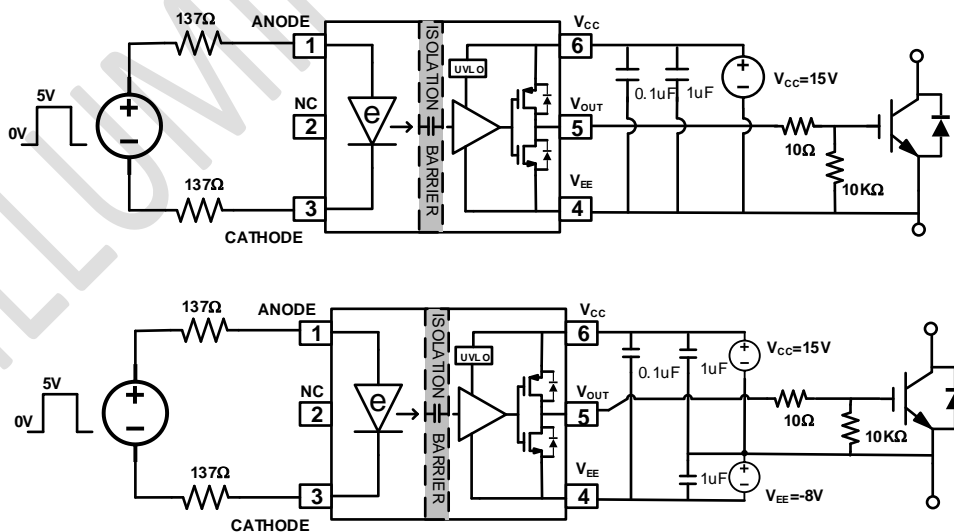



FIG. 1 SLM345 Single and Bipolar Power Supplies Application Circuit to Drive IGBT

Preliminary Datasheet

4 PIN CONFIGURATION

Package	Pin Configuration (Top View)
Stretched SO6	

5 PIN DESCRIPTION

No.	Pin	Description
1	ANODE	Anode
2	NC	No Connection
3	CATHODE	Cathode
4	VEE	Negative Power Supply Rail
5	V _{OUT}	Gate Drive Output
6	V _{CC}	Positive Power Supply Rail

6 FUNCTIONAL BLOCK DIAGRAM

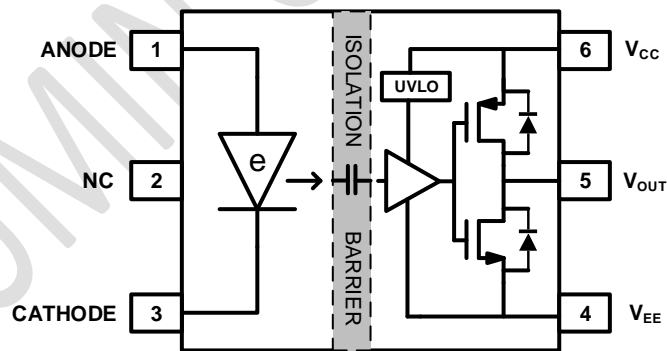

FIG. 2 SLM345

ORDERING INFORMATION

Order Part No.	Package	QTY
SLM345CK-DG	SO6, Pb-Free	1000/Reel

Preliminary Datasheet

PACKAGE CASE OUTLINES

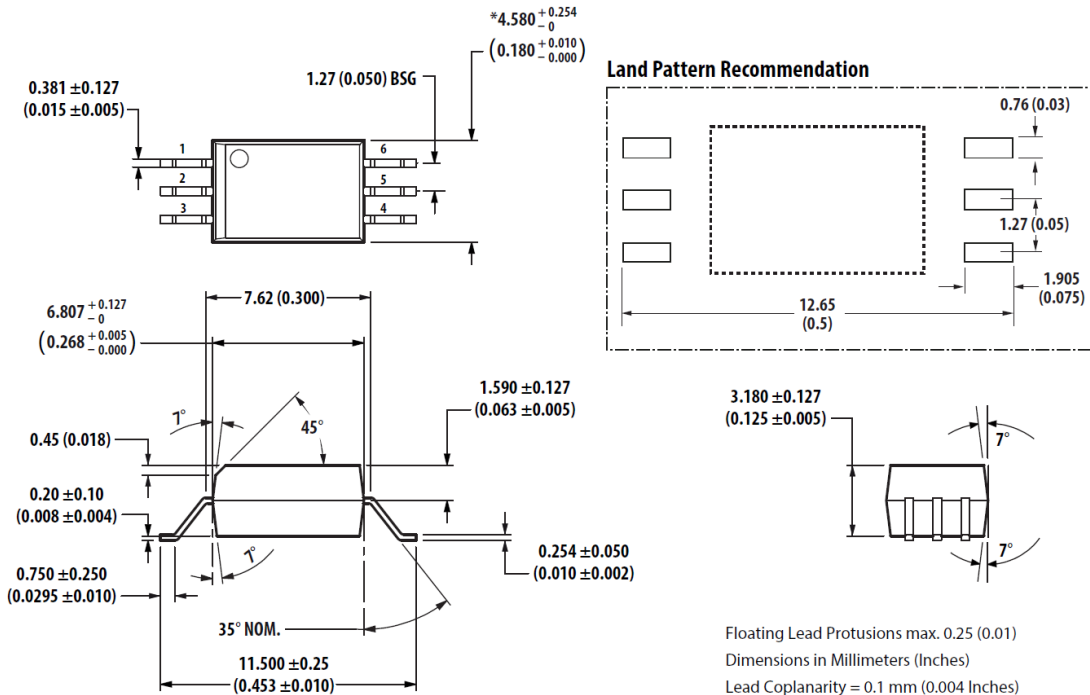

Floating Lead Protusions max. 0.25 (0.01)
 Dimensions in Millimeters (Inches)
 Lead Coplanarity = 0.1 mm (0.004 Inches)
 *Total package length (inclusive of mold flash)
 4.834 ± 0.254 (0.190 ± 0.010)

Preliminary Datasheet

Revision History

SILLUMIN CONFIDENTIAL