

Features

- 650-Volt Schottky Rectifier
- Reduced V_F for Improved Efficiency
- High Humidity Resistance
- Zero Forward and Reverse Recovery Voltage
- Temperature-Independent Switching Behavior
- Extremely Fast Switching
- Positive Temperature Coefficient on V_F

Benefits

- Replace Bipolar with Unipolar Rectifiers
- Essentially No Switching Losses
- Higher Efficiency
- Reduction of Heat Sink Requirements
- Parallel Devices Without Thermal Runaway

Applications

- Power Inverters
- Motor Drives
- EV Chargers
- Power Factor Correction
- Server Power Supplies

Package

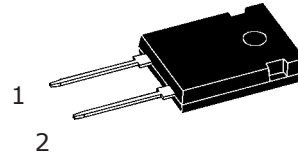

TO-247



Maximum Ratings ($T_C = 25^\circ\text{C}$ unless otherwise specified)

Symbol	Parameter	Value	Unit	Test Conditions	Note
V_{RRM}	Repetitive Peak Reverse Voltage	650	V		
V_{RSM}	Surge Peak Reverse Voltage	650	V		
V_{DC}	DC Peak Blocking Voltage	650	V		
I_F	Continuous Forward Current	86 39 30	A	$T_C=25^\circ\text{C}$ $T_C=135^\circ\text{C}$ $T_C=149^\circ\text{C}$	Fig. 3
I_{FRM}	Repetitive Peak Forward Surge Current	136 92.5	A	$T_C=25^\circ\text{C}, t_p=10\text{ ms}, \text{Half Sine Pulse}$ $T_C=110^\circ\text{C}, t_p=10\text{ ms}, \text{Half Sine Pulse}$	
I_{FSM}	Non-Repetitive Forward Surge Current	309 270	A	$T_C=25^\circ\text{C}, t_p=10\text{ ms}, \text{Half Sine Pulse}$ $T_C=110^\circ\text{C}, t_p=10\text{ ms}, \text{Half Sine Pulse}$	Fig. 8
$I_{F,Max}$	Non-Repetitive Peak Forward Current	2100 1650	A	$T_C=25^\circ\text{C}, t_p=10\text{ }\mu\text{s}, \text{Pulse}$ $T_C=110^\circ\text{C}, t_p=10\text{ }\mu\text{s}, \text{Pulse}$	Fig. 8
P_{tot}	Power Dissipation	282.5 122	W	$T_C=25^\circ\text{C}$ $T_C=110^\circ\text{C}$	Fig. 4
$\int i^2 dt$	i^2t value (Per Leg)	212 162	A^2s	$T_C=25^\circ\text{C}, t_p=10\text{ ms}$ $T_C=110^\circ\text{C}, t_p=10\text{ ms}$	
T_J, T_{stg}	Operating Junction and Storage Temperature	-55 to +175	$^\circ\text{C}$		
	TO-220 Mounting Torque	1 8.8	Nm lbf-in	M3 Screw 6-32 Screw	

Electrical Characteristics

Symbol	Parameter	Typ.	Max.	Unit	Test Conditions	Note
V_F	Forward Voltage	1.35 1.65	1.55 1.80	V	$I_F = 20\text{ A}$, $T_J = 25^\circ\text{C}$ $I_F = 20\text{ A}$, $T_J = 175^\circ\text{C}$	Fig. 1
I_R	Reverse Current	8 2	80	μA	$V_R = 650\text{ V}$, $T_J = 25^\circ\text{C}$ $V_R = 400\text{ V}$, $T_J = 25^\circ\text{C}$	Fig. 2
		30 5	300	μA	$V_R = 650\text{ V}$, $T_J = 175^\circ\text{C}$ $V_R = 400\text{ V}$, $T_J = 175^\circ\text{C}$	Fig. 2
Q_C	Total Capacitive Charge	62		nC	$V_R = 400\text{ V}$ $di/dt = 500\text{ A}/\mu\text{s}$ $T_J = 25^\circ\text{C}$	Fig. 5
C	Total Capacitance	1100		pF	$V_R = 0\text{ V}$, $T_J = 25^\circ\text{C}$, $f = 1\text{ MHz}$	Fig. 6
		113			$V_R = 200\text{ V}$, $T_J = 25^\circ\text{C}$, $f = 1\text{ MHz}$	
		108			$V_R = 400\text{ V}$, $T_J = 25^\circ\text{C}$, $f = 1\text{ MHz}$	
E_C	Capacitance Stored Energy	9.5		μJ	$V_R = 400\text{ V}$	Fig. 7

Note: This is a majority carrier diode, so there is no reverse recovery charge.

Thermal Characteristics

Symbol	Parameter	Typ.	Unit
$R_{\theta JC}$	Thermal Resistance from Junction to Case	0.8	$^\circ\text{C}/\text{W}$

Typical Performance

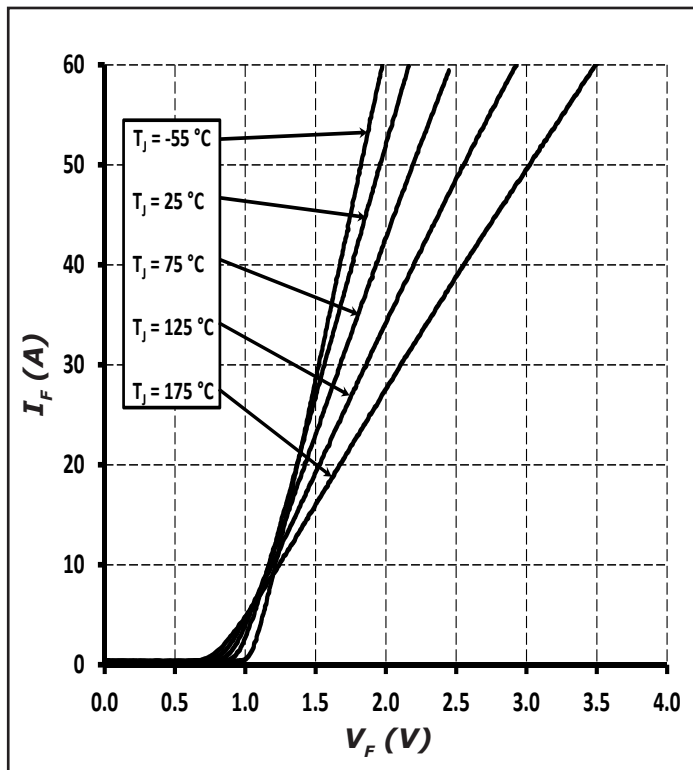

Figure 1. Forward Characteristics

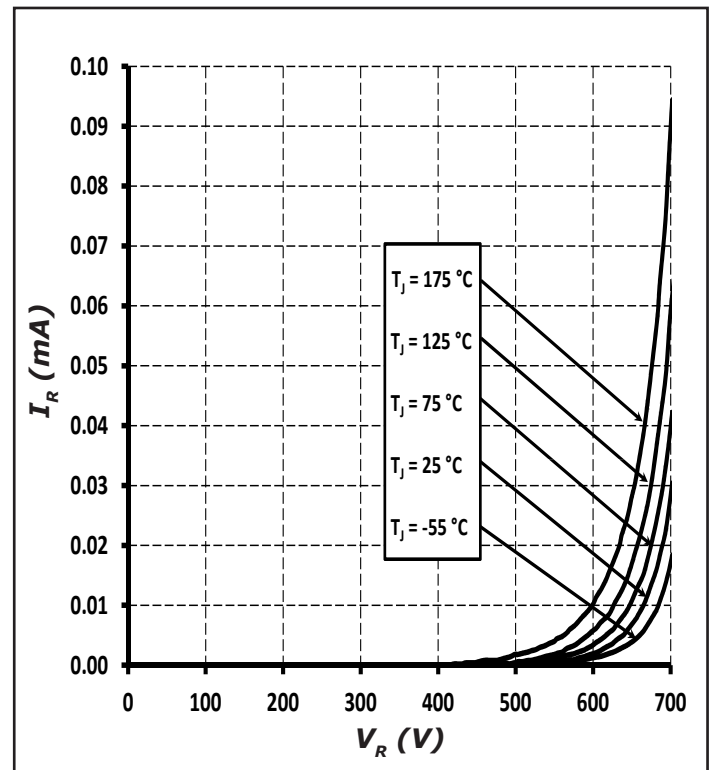

Figure 2. Reverse Characteristics

Typical Performance

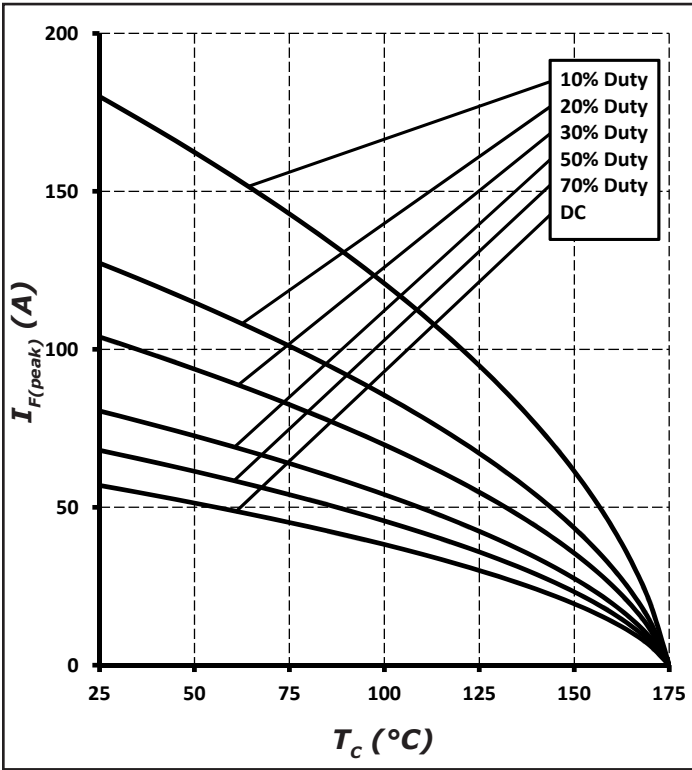

Figure 3. Current Derating

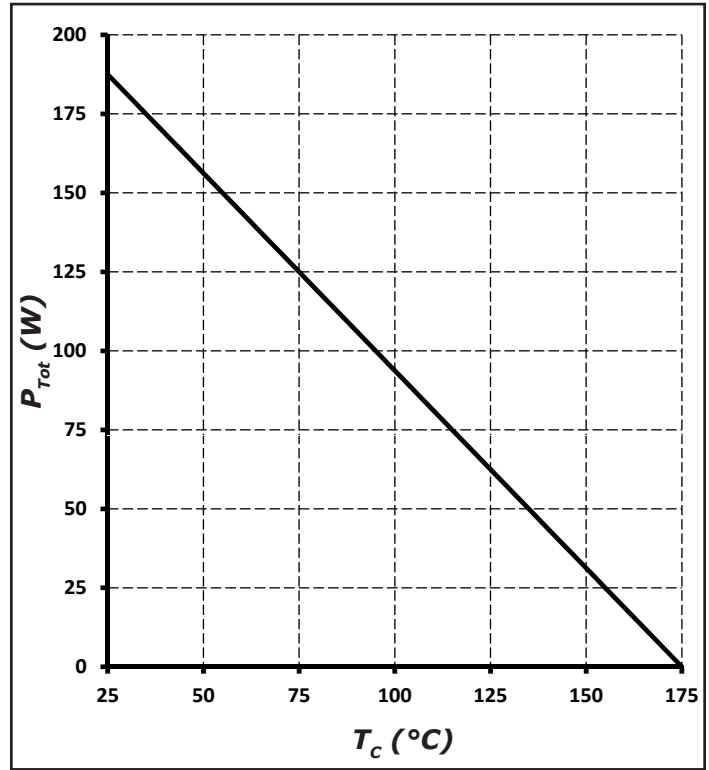

Figure 4. Power Derating

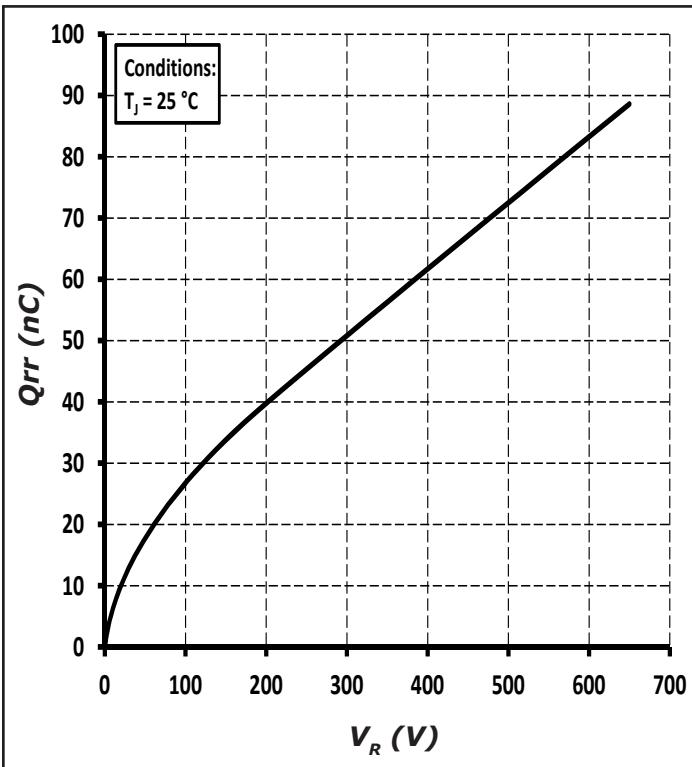

Figure 5. Recovery Charge vs. Reverse Voltage

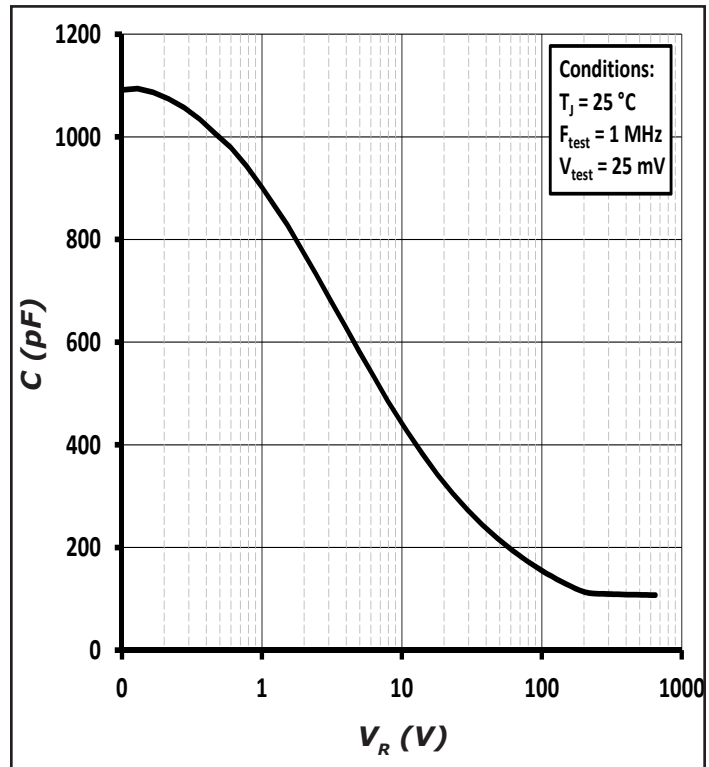

Figure 6. Capacitance vs. Reverse Voltage

Typical Performance

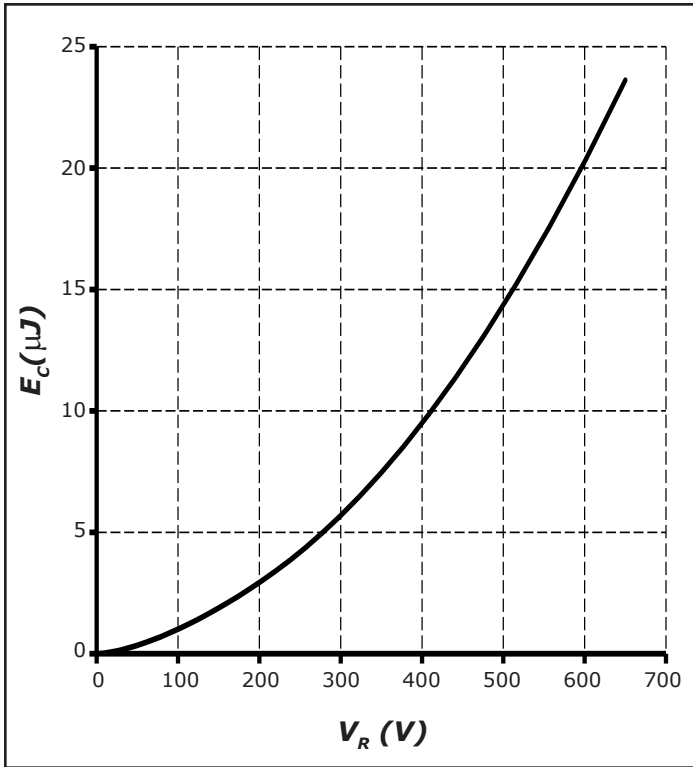

Figure 7. Typical Capacitance Stored Energy

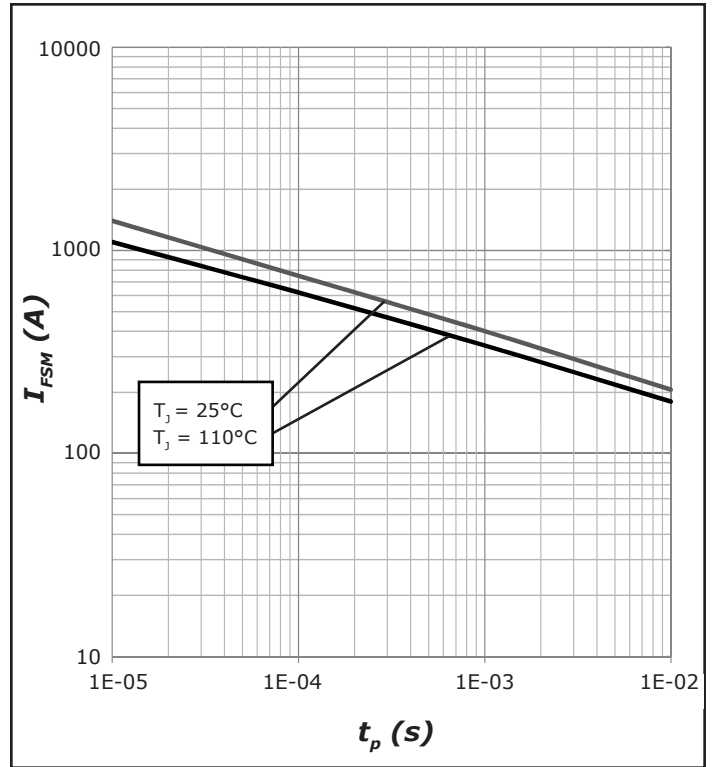

Figure 8. Non-Repetitive Peak Forward Surge Current versus Pulse Duration (sinusoidal waveform)

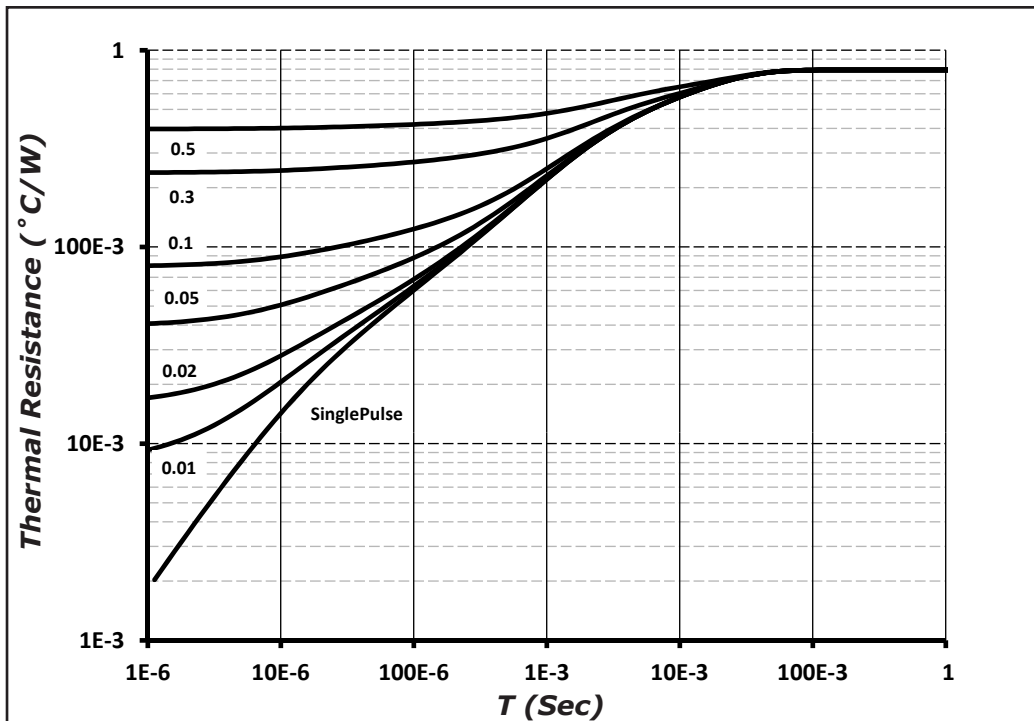
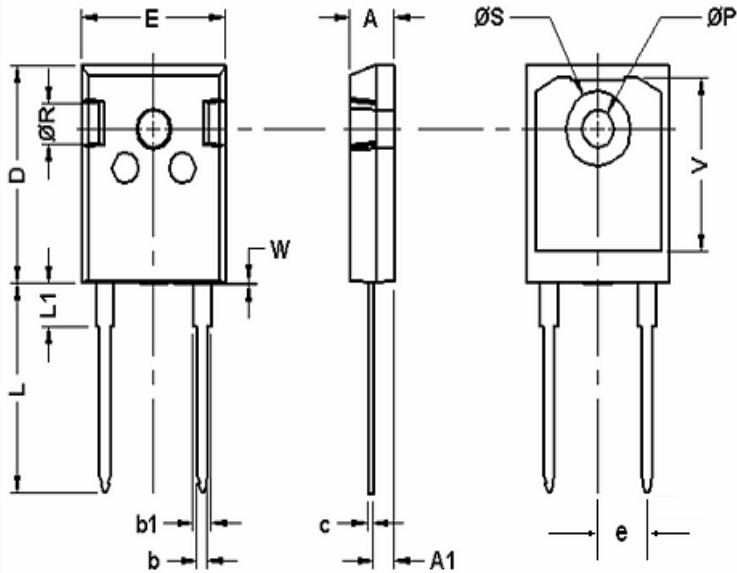

Figure 9. Transient Thermal Impedance

Package Dimensions



POS	Inches		Millimeters	
	Min	Max	Min	Max
A	0.185	0.209	4.70	5.31
A1	0.087	0.102	2.21	2.59
b	0.040	0.055	1.02	1.40
b1	0.065	0.088	1.65	2.23
C	0.016	0.031	0.41	0.79
D	0.819	0.845	20.80	21.46
E	0.61	0.640	15.49	16.26
e	0.215	0.215	5.46	5.46
L	0.78	0.80	19.81	20.32
L1	0.164	0.176	4.17	4.47
øP	0.140	0.144	3.56	3.66
Q	0.212	0.244	5.38	6.20
øR	0.135	0.157	3.43	3.99
øS	0.278	0.288	7.06	7.32
V	0.652	0.662	16.56	16.81
W	0.000	0.006	0.00	0.15

