

N-Channel Enhancement-Mode MOSFET (20V, 6.0A)

PRODUCT SUMMARY

V_{DSS}	I_D	$R_{DS(on)}$ (m Ω)Typ
20V	8A	10@ $V_{GS} = 4.5V, I_D=8A$ 15@ $V_{GS} = 2.5V, I_D=5A$

Features

- Super high dense cell trench design for low $R_{DS(on)}$
- Rugged and reliable
- SOT-23-3L package
- Lead (Pb) -free and halogen-free

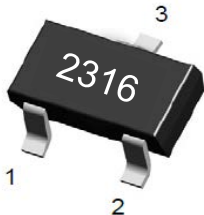
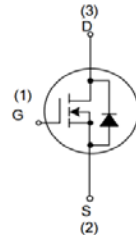
	<p>ET2316 Pin Assignment & Symbol 3-Lead Plastic SOT-23-3L Pin 1: Gate Pin 2: Source Pin3: Drain</p>	
--	--	--

Absolute Maximum Ratings ($T_A=25^\circ C$, unless otherwise noted)

Symbol	Parameter	Ratings	Units
V_{DS}	Drain-Source Voltage	20	V
V_{GS}	Gate-Source Voltage	± 12	V
I_D	Drain Current (Continuous)	8	A
I_{DM}	Drain Current (Pulsed) ^a	28	A
P_D	Total Power Dissipation @ $T_A=25^\circ C$	1.25	W
	Total Power Dissipation @ $T_A=75^\circ C$	0.75	W
T_j, T_{stg}	Operating Junction and Storage Temperature Range	-55 to +150	$^\circ C$
R_{QJA}	Thermal Resistance Junction to Ambient (PCB mounted) ^b	100	$^\circ C/W$

a: Repetitive Rating; Pulse width limited by the maximum junction temperature.

b: 1-in² 2oz Cu PCB board



Electrical Characteristics (T_A=25°C, unless otherwise noted)

Symbol	Characteristic	Test Conditions	Min.	Typ.	Max.	Unit
• Off Characteristics						
BV _{DSS}	Drain-Source Breakdown Voltage	V _{GS} =0V, I _D =-250uA	20	-	-	V
I _{DSS}	Zero Gate Voltage Drain Current	V _{DS} =20V, V _{GS} =0V	-	-	1	μA
I _{GSS}	Gate-Body Leakage Current	V _{GS} =±10V, V _{DS} =0V	-	-	±100	nA
• On Characteristics						
V _{GS(th)}	Gate Threshold Voltage	V _{DS} =V _{GS} , I _D =-250uA	0.45	0.65	1	V
R _{DS(on)}	Drain-Source On-State Resistance	V _{GS} =4.5V, I _D =8A	-	10	13	mΩ
		V _{GS} =2.5V, I _D =5A		15	18	
g _{FS}	Forward Transconductance	V _{DS} =5V, I _D =6A		50		S
I _s	Maximum Body-Diode Continuous Current				4	A
• Dynamic Characteristics						
C _{iss}	Input Capacitance	V _{DS} =10V, V _{GS} =0V, f=1MHz	-	1150	-	PF
C _{oss}	Output Capacitance		-	170	-	
C _{rss}	Reverse Transfer Capacitance		-	105	-	
R _g	Gate resistance	V _{DS} =10V, V _{GS} =0V, f=1MHz		2.2		Ω
• Switching Characteristics						
Q _g	Total Gate Charge	V _{DS} =10V, I _D =6A, V _{GS} =4.5V	-	13	-	nC
Q _{gs}	Gate-Source Charge		-	1.4	-	
Q _{gd}	Gate-Drain Charge		-	2.9	-	
t _{d(on)}	Turn-on Delay Time	V _{DS} =10V, R _L =1.25Ω V _{GS} =4.5V, R _G =3Ω	-	2.9	-	nS
t _r	Turn-on Rise Time		-	2.8	-	
t _{d(off)}	Turn-off Delay Time		-	36	-	
t _f	Turn-off Fall Time		-	8	-	
• Drain-Source Diode Characteristics						
V _{SD}	Drain-Source Diode Forward Voltage	V _{GS} =0V, I _S =-1A	-	0.6	1	V

Note: Pulse Test: Pulse Width ≤ 300us, Duty Cycle ≤ 2%

Typical Characteristics Curves (Ta=25°C, unless otherwise note)

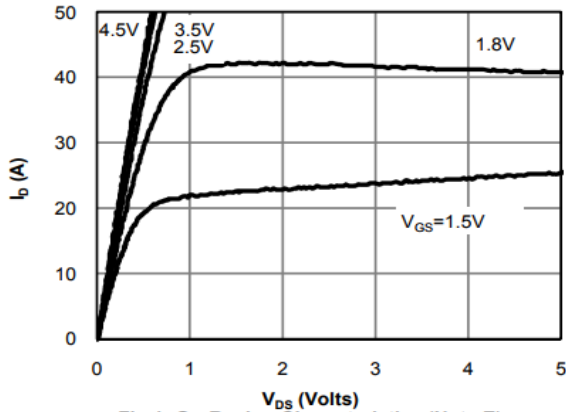

Fig 1: On-Region Characteristics (Note E)

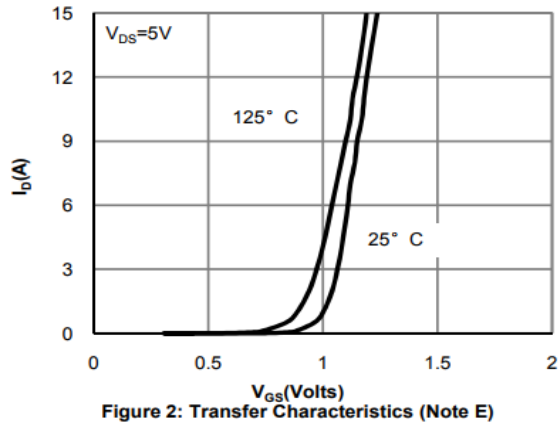

Figure 2: Transfer Characteristics (Note E)

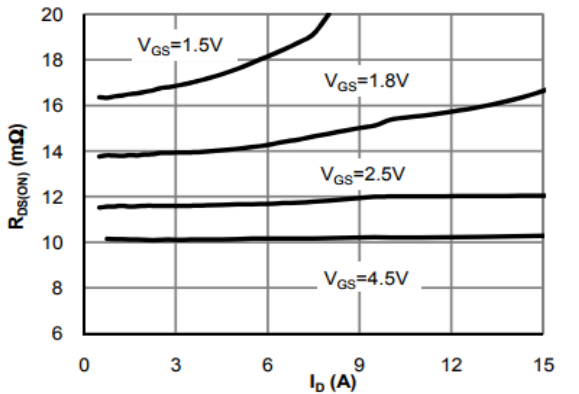

Figure 3: On-Resistance vs. Drain Current and Gate Voltage (Note E)

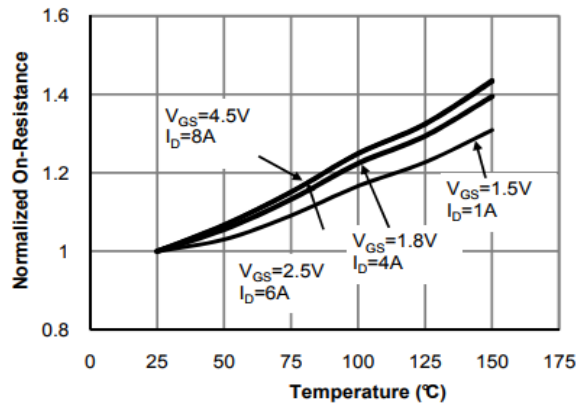

Figure 4: On-Resistance vs. Junction Temperature (Note E)

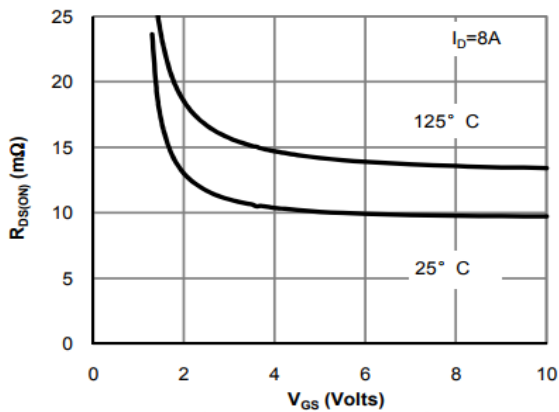

Figure 5: On-Resistance vs. Gate-Source Voltage (Note E)

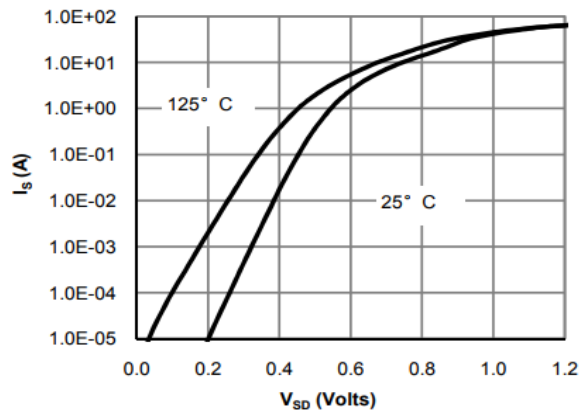

Figure 6: Body-Diode Characteristics (Note E)

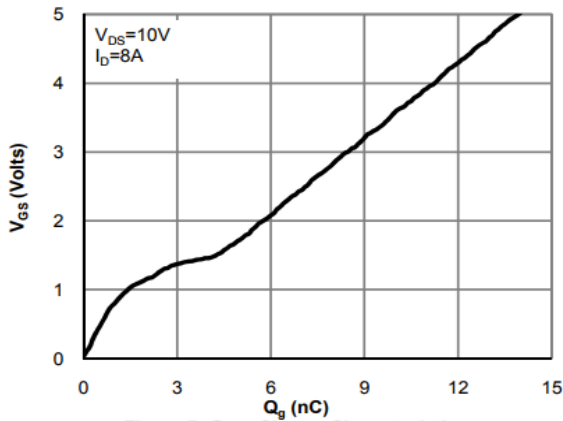

Figure 7: Gate-Charge Characteristics

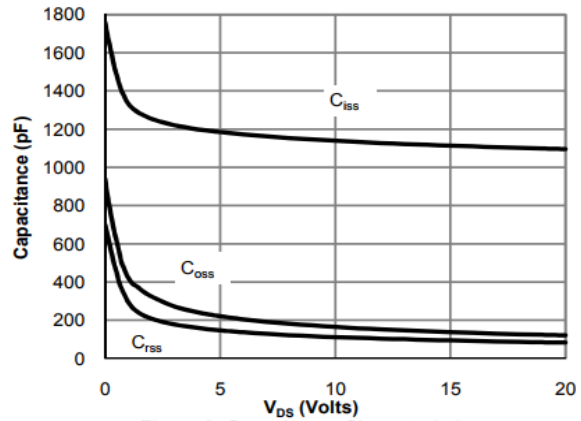

Figure 8: Capacitance Characteristics

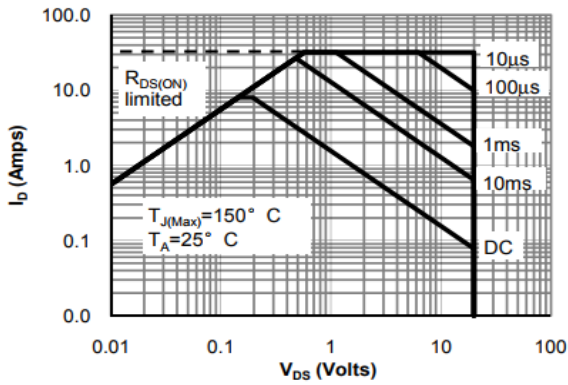

Figure 9: Maximum Forward Biased Safe Operating Area (Note F)

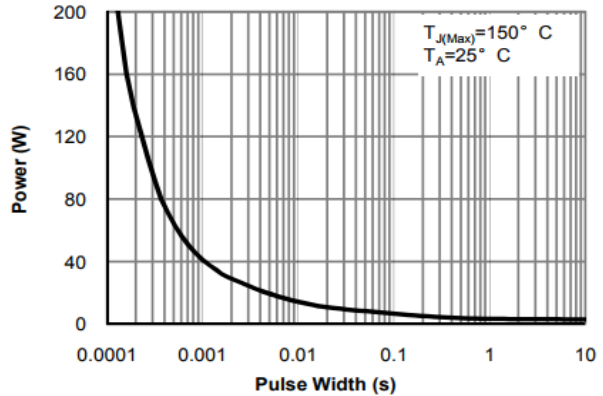

Figure 10: Single Pulse Power Rating Junction-to-Ambient (Note F)

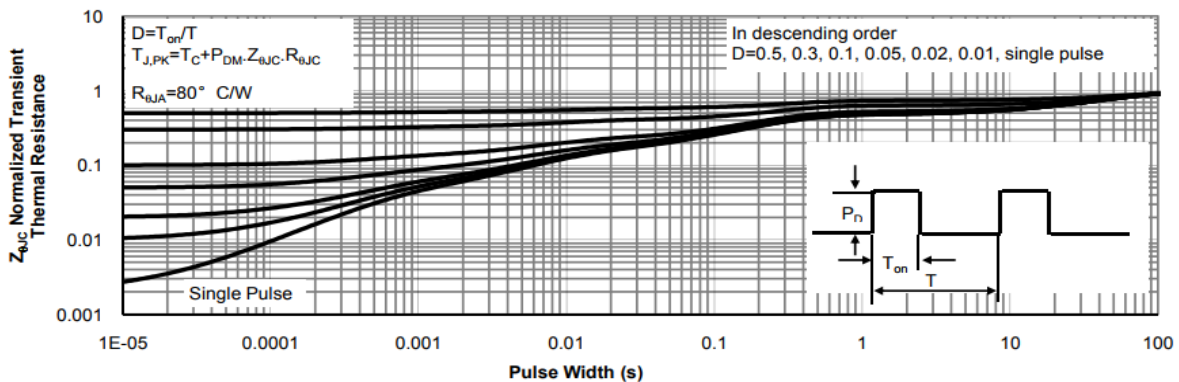
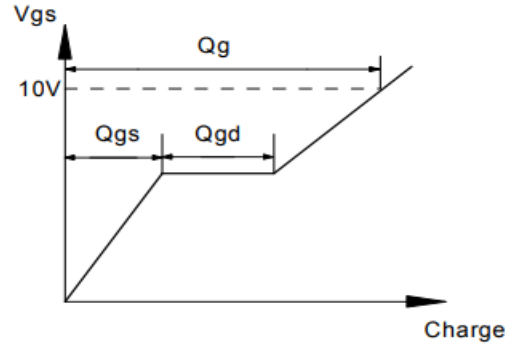
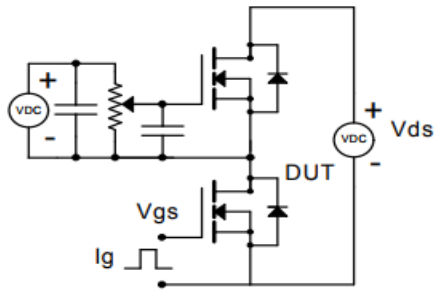
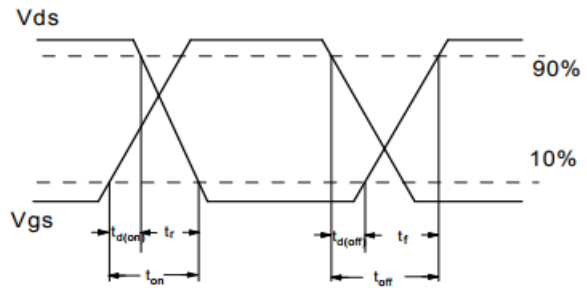
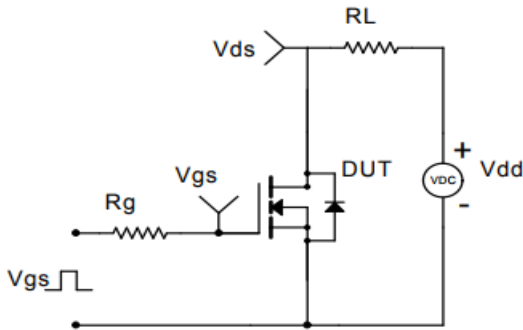

Figure 11: Normalized Maximum Transient Thermal Impedance (Note F)

Gate Charge Test Circuit & Waveform



Resistive Switching Test Circuit & Waveforms



Unclamped Inductive Switching (UIS) Test Circuit & Waveforms

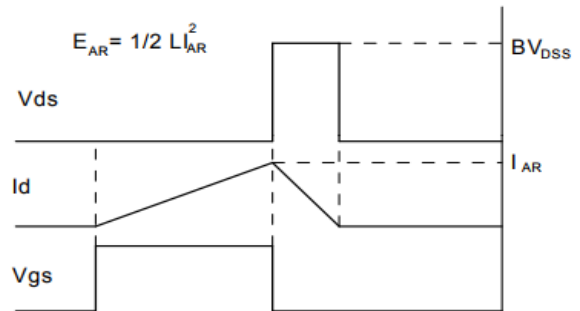
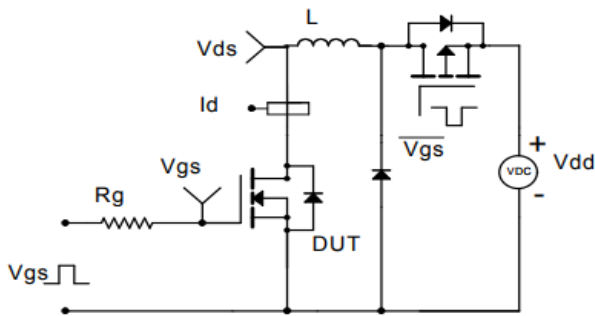

Diode Recovery Test Circuit & Waveforms

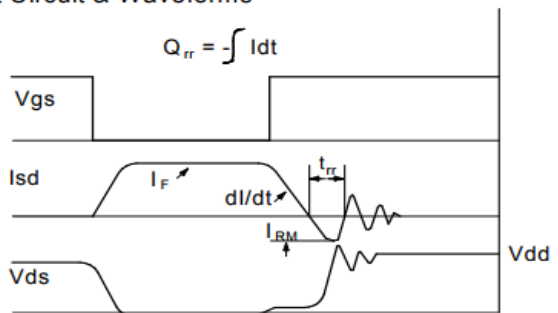
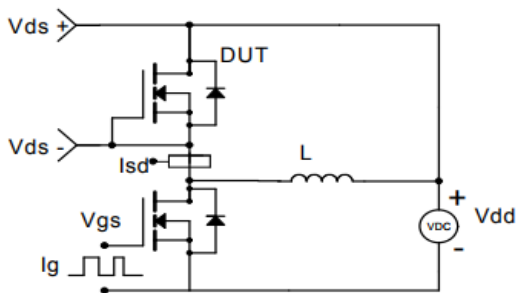

SOT23-3L PACKAGE OUTLINE DIMENSIONS

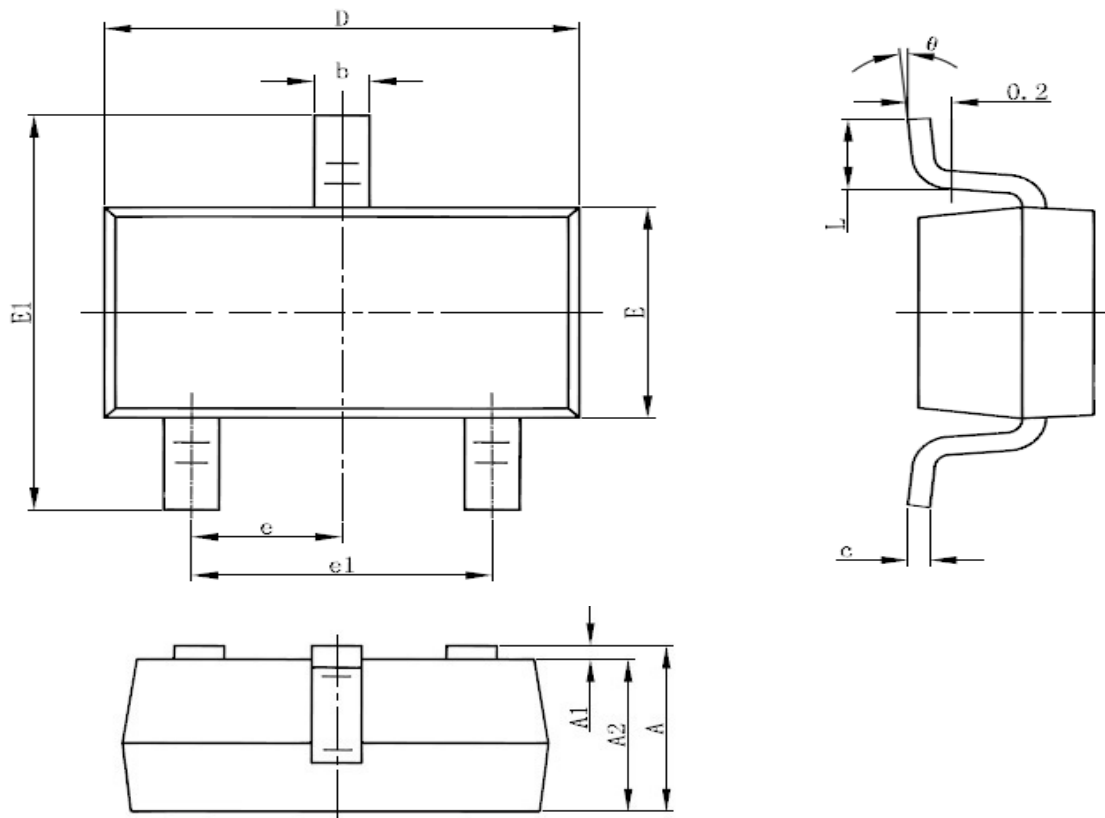

Symbol	Dimensions In Millimeters		Dimensions In Inches	
	Min	Max	Min	Max
A	0.850	1.250	0.033	0.049
A1	0.000	0.100	0.000	0.004
A2	0.7	1.150	0.028	0.045
b	0.300	0.500	0.012	0.020
c	0.100	0.200	0.004	0.008
D	2.820	3.020	0.111	0.119
E	1.500	1.700	0.059	0.067
E1	2.650	2.950	0.104	0.116
e	0.950(BSC)		0.037(BSC)	
e1	1.800	2.000	0.071	0.079
L	0.300	0.600	0.012	0.024
θ	0°	8°	0°	8°