

Material:

- * Insulation: High Temperature Plastic
UL 94V-0, Color Black
- * Contact: Brass
- * Fixed Tabs: Brass with Matte Tin Plated

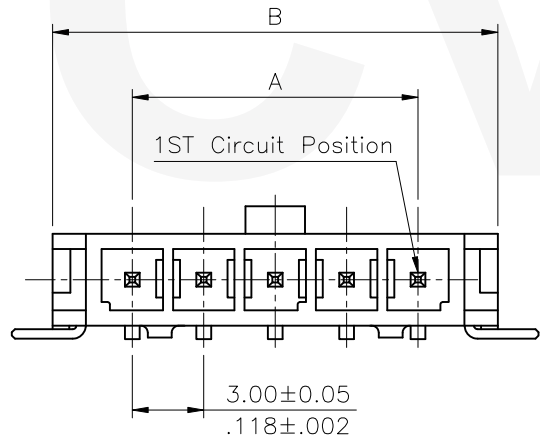
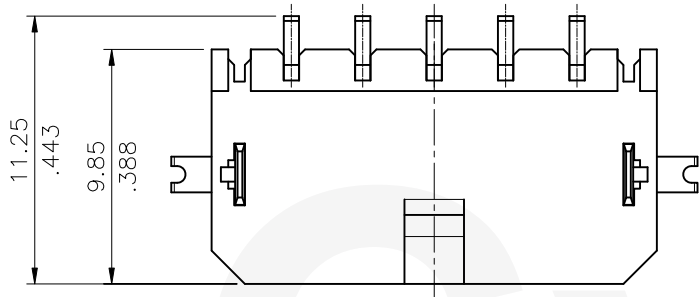

Ordering Code:

CP35 ** P * H S T - S - LF
① ② ③ ④ ⑤ ⑥ ⑦ ⑧ ⑨

- ① Series No.
- ② No. of Circuits: 02~12
- ③ Contact type: P= Plug
- ④ Contact plated:
 - 1= Matte Tin Plated over Nickel
 - A= Selective Gold Flash Plated over 1.27μm(50μ") Nickel
 - B= Selective 0.38μm(15μ") Gold Plated over 1.27μm(50μ") Nickel
 - C= Selective 0.76μm(30μ") Gold Plated over 1.27μm(50μ") Nickel
- ⑤ H= Right angle type
- ⑥ Mount type : S= SMT Type
- ⑦ Other options: T= With Fixed Tabs
- ⑧ S= Single Row Header
- ⑨ LF= Lead Free soldering process

CIRCUITS	DIM.A	DIM.B	DIM.C
2	3.00(.118)	9.65(.380)	14.2(.559)
3	6.00(.236)	12.65(.498)	17.2(.677)
4	9.00(.354)	15.65(.616)	20.2(.795)
5	12.00(.472)	18.65(.734)	23.2(.913)
6	15.00(.591)	21.65(.852)	26.2(1.031)
7	18.00(.709)	24.65(.970)	29.2(1.150)
8	21.00(.827)	27.65(1.089)	32.2(1.268)
9	24.00(.945)	30.65(1.207)	35.2(1.386)
10	27.00(1.063)	33.65(1.325)	38.2(1.504)
11	30.00(1.181)	36.65(1.443)	41.2(1.622)
12	33.00(1.299)	39.65(1.561)	44.2(1.740)

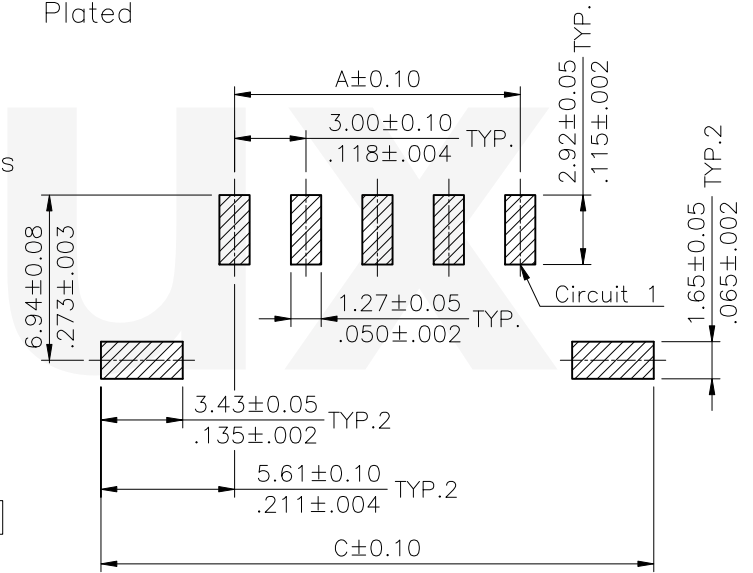
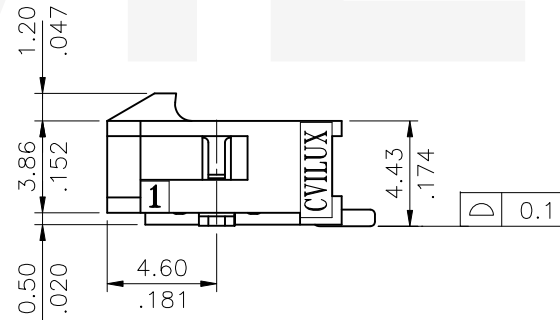

Recommended P.C. Board Layout

Lead Free Process
RoHS Compliant

SYM	NAME	DATE	REVISIONS	APPROVED BY:	DATE	UNIT: mm / inch	TITLE: 3.00mm PITCH RIGHT ANGLE SMT TYPE POWER CONN.	瀚荃股份有限公司 CviLux Corporation
⑧	Yushu	4/11-19'	ECRB118091/ECNT119092					
⑦	Sandy	7/2-12'	ECN12127-0	DRAWN BY: Yushu	5/30-19'	TOLERANCE UNLESS OTHERWISE SPECIFIED		
⑥	Sandy	6/15-12'	ECN12105-0	ENGINEER: Sun	6/03-19'	.X ± 0.30/.012 .X' ± 1'	MATERIAL:	
⑤	Sun	3/03-12'	ECR11051-1/ECN11229	CHECKED BY: Eisley	6/05-19'	.XX ± 0.20/.008 .X' ±	FINISH:	
				APPROVED BY: Eisley	6/05-19'	.XXX ± 0.10/.004 .XX' ±		

2019.06.13
ISSUED

Feeding direction

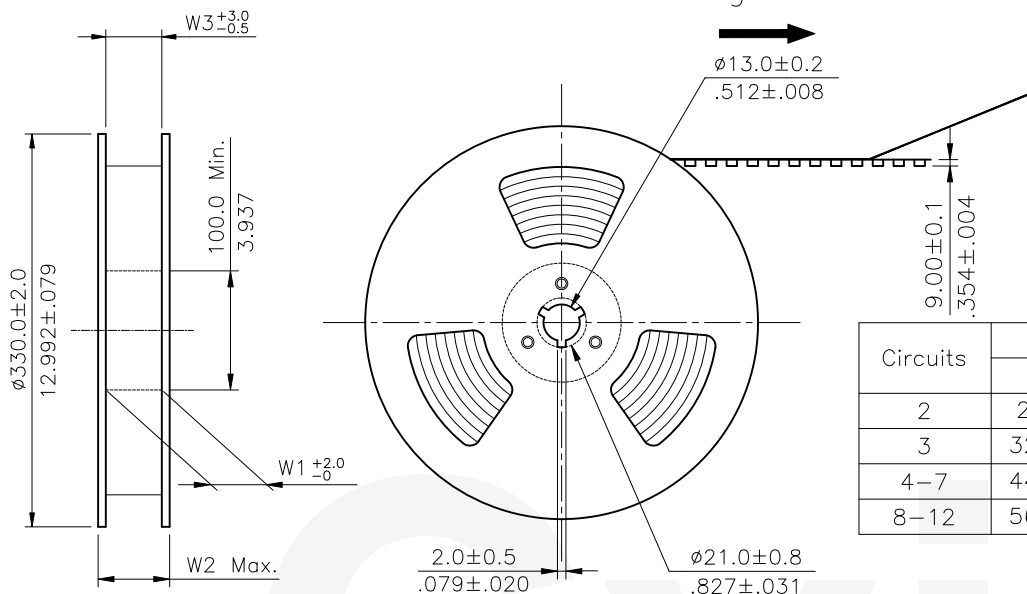

NOTE :

- ⚠ * Reel Material : Corrugated Paper
- ⚠ * Carrier Material : Transparent,Conductive Polystyrene Alloy
- * Cover Tape Material : Polyester
- * Cover Tape Peel Strength : 0.1N – 1.3N
- * Carrier camber is within 1mm in 250mm
- * All dimensions meet EIA-481-B requirements.
- * Quantity : 320 PCS/Reel

Circuits	Dimension					Packing (Reel/Carton)
	E	F	W1	W2	W3	
2	24.0(.945)	—	24.5(.965)	30.5(1.200)	24.5(.965)	9
3	32.0(1.260)	28.40(1.118)	32.5(1.280)	38.5(1.516)	32.5(1.280)	7
4-7	44.0(1.732)	40.40(1.596)	44.5(1.752)	50.5(1.988)	44.5(1.752)	5
8-12	56.0(2.205)	52.40(2.063)	56.5(2.224)	62.5(2.461)	56.5(2.224)	4

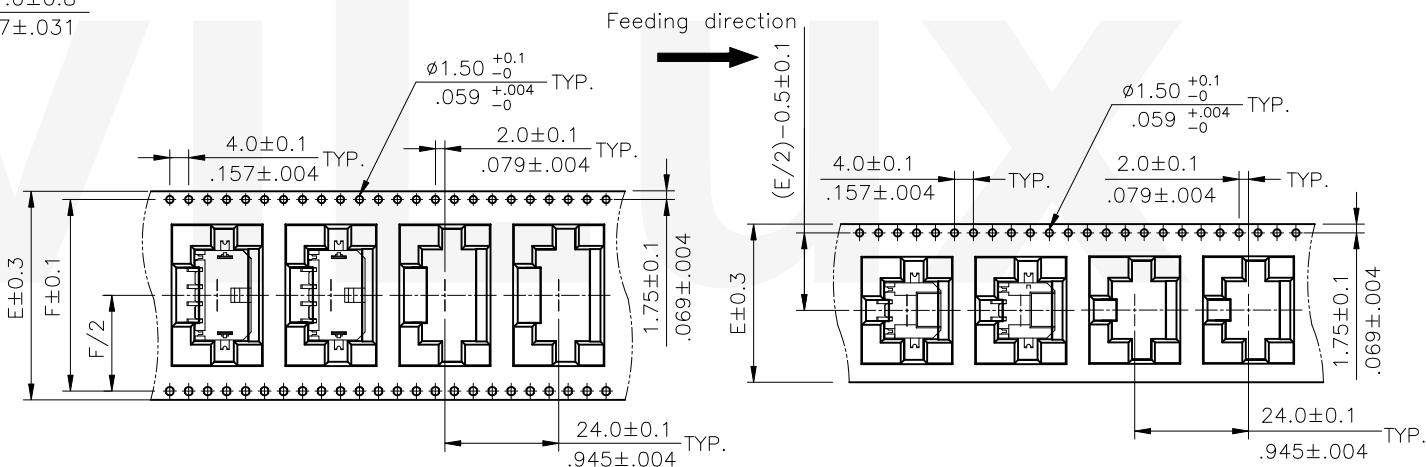
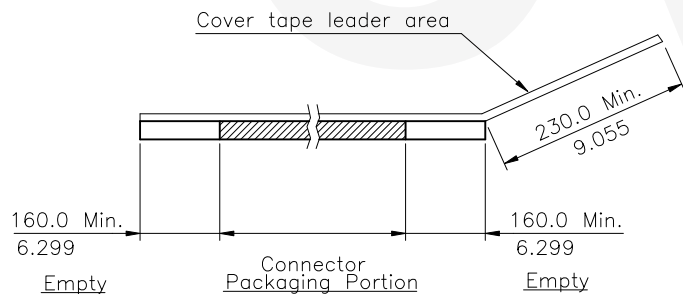

WIDTH :24 mm Carrier

⚠ ⚠ WIDTH : 32,44,56 mm Carrier

RoHS Compliant

8	Yushu	4/11-19'	ECRB118091/ECNT119092		DATE	UNIT: mm / inch	TITLE: 3.00mm PITCH RIGHT ANGLE SMT TYPE POWER CONN.	 瀚荃股份有限公司 CviLux Corporation
7	Sandy	7/2-12'	ECN12127-0	DRAWN BY: Yushu	5/30-19'	TOLERANCE UNLESS OTHERWISE SPECIFIED	MATERIAL:	
6	Sandy	6/15-12'	ECN12105-0	ENGINEER: Sun	6/03-19'	.X ± .X' ± 1'	CUSTOMER:	DRAWING NO. CP3566SH
5	Sun	3/03-12'	ECR11051-1/ECN11229	CHECKED BY: Eisley	6/05-19'	.XX ± .X' ±		PART NO. CP35**P*HST-S-LF
SYM	NAME	DATE	REVISIONS	APPROVED BY: Eisley	6/05-19'	.XXX ± .XX' ±		SCALE
								SHEET 2 OF 2

 CIVILUX CORP
 2019.06.13
 ISSUED