

1 2 3 4 5 6 7 8

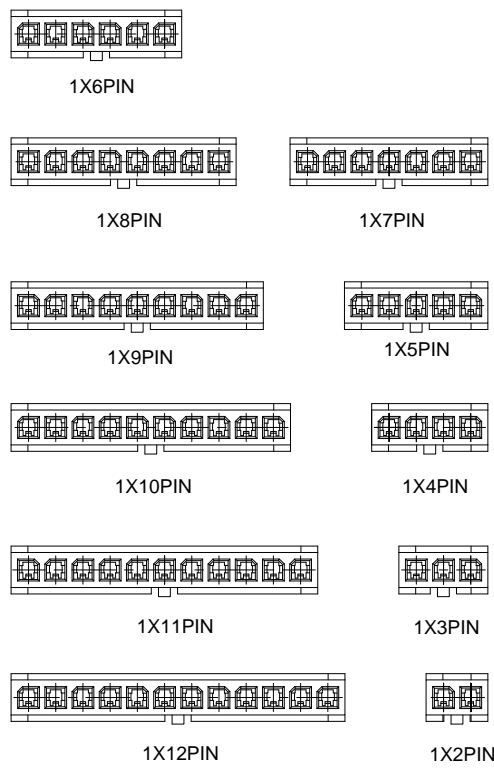
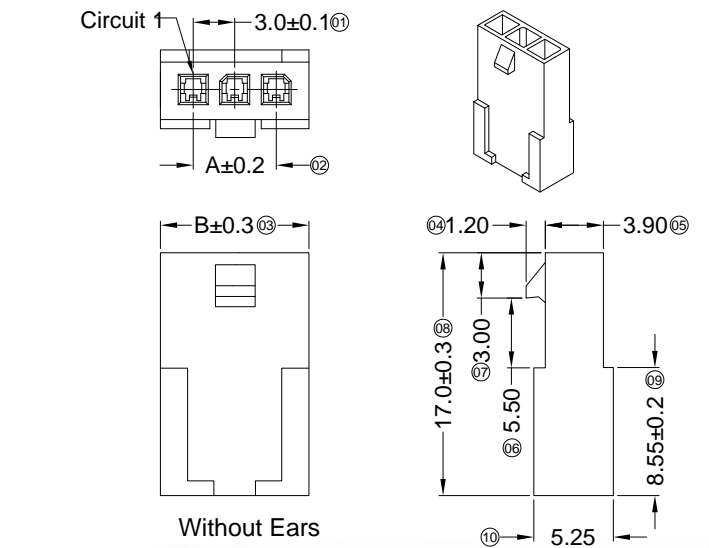
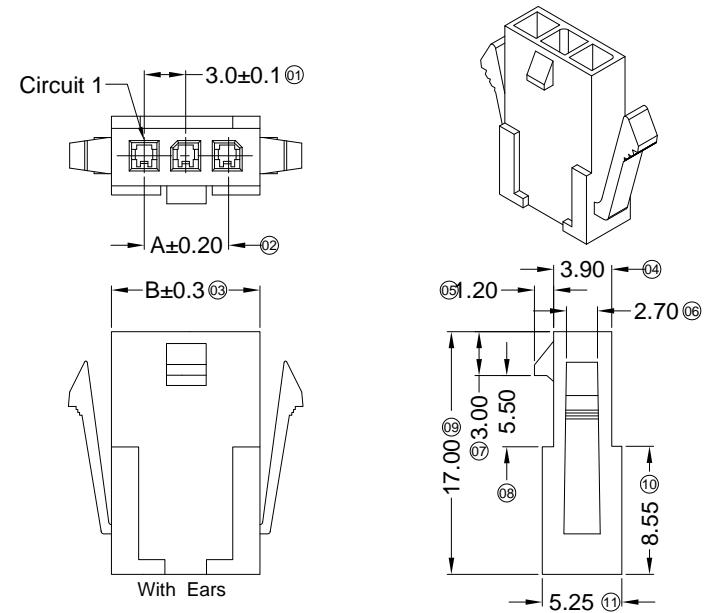

- Specifications :**
- Voltage rating: 250V AC / DC
 - Current rating: 5A AC / DC
 - Withstanding voltage: 1000V AC/minute
 - Temperature range: -40°C~+105°C
 - Insulation resistance: ≥1000MΩ
 - Contact resistance: ≤10mΩ
 - After environmental testing: ≤20mΩ

X3025 H F-XX XX-N2 XX
 ① ② ③ ④ ⑤ ⑥ ⑦

- ① Series No.
- ② Category: H-HSG
- ③ Welding Board Angle: F-Female HSG
- ④ Row No.-Pin No.: XX-02P~12P
- ⑤ Plug the Pin & special No.: I-Without Ears
G-With Ears
- ⑥ Material: N2-PA66 94V-2;
- ⑦ Color: Blank-Natural Color ; WH-White

Poles	Dimensions(mm)		Poles	Dimensions(mm)	
	A	B		A	B
02	3.00	6.90	08	21.00	24.90
03	6.00	9.90	09	24.00	27.90
04	9.00	12.90	10	27.00	30.90
05	12.00	15.90	11	30.00	33.90
06	15.00	18.90	12	33.00	36.90
07	18.00	21.90			

X3025HF-XXG-N2	Nylon 66 94V-2	Natural Color	X3025TM	X3025HM	With Ears
X3025HF-XXG-N2WH	Nylon 66 94V-2	White			Without Ears
X3025HF-XXI-N2	Nylon 66 94V-2	Natural Color	X3025TM	X3025HM	With Ears
X3025HF-XXI-N2WH	Nylon 66 94V-2	White			Without Ears
PART NO	Material	Color	Suitable XKB Terminal	Mates With XKB Housing	Note

For and on behalf of
XKB INDUSTRIAL PRECISION CO., LIMITED
 香港星坤工業精密有限公司

MARK	DESCRIPTION	DATE	REVISED	APPROVED	UNSPECIFIED TOLERANCES
△ X					ANGULAR ± 5°
△ X					L ≤ 4 ± 0.2
△ X					4 < L ≤ 16 ± 0.3
					16 < L ≤ 63 ± 0.4
					L > 63 ± 0.5

DSND	DATE	SCALE: N/A	MODEL TYPE: X3025HF-XXX-N2
DWN	DATE	VIEW:	PART NO.:
CHKD	DATE	UNIT: mm	3.00 mm Crimp Style Connectors
APPD	DATE	SIZE: A4	DWG NO.:
			WEIGHT 1.0g
			SHEET 1/1
			REVISION A0

REVISIONS
 Authorized Signature(s)

XKB INDUSTRIAL PRECISION CO., LIMITED

1 2 3 4 5 6 7 8

1 2 3 4 5 6 7 8

A

B

C

D

E

F

A

B

C

D

E

F

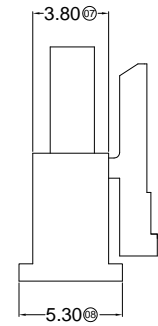
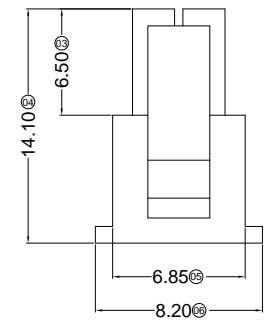
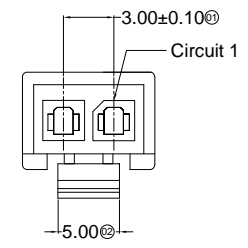
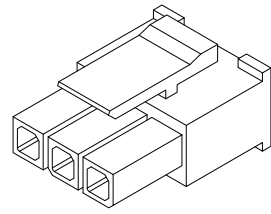
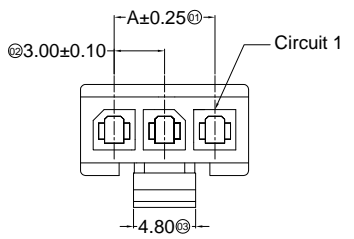

Specifications :

- Voltage rating: 250V AC / DC
- Current rating: 5A AC / DC
- Withstanding voltage: 1000V AC/minute
- Temperature range: -40°C~+105°C
- Insulation resistance: ≥1000MΩ
- Contact resistance: ≤10mΩ
- After environmental testing: ≤20mΩ

X3025 H M-XX X-N2 XX

① ②③④⑤⑥⑦

- ① Series No.
- ② Category: H-HSG
- ③ Welding Board Angle: M-Male HGS
- ④ Row No.-Pin No.: XX-02P~12P
- ⑤ Plug the Pin & special No.
- ⑥ Material: N2-PA66 94V-2
- ⑦ Color: Blank-Natural Color

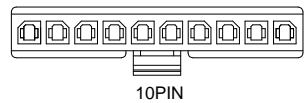
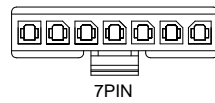
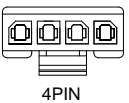
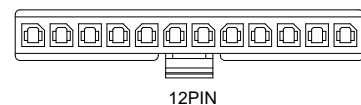
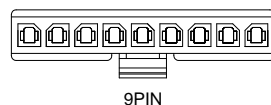
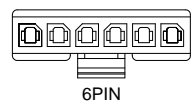
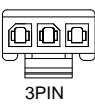
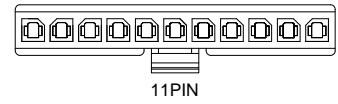
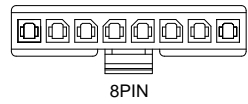
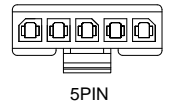
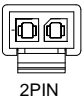
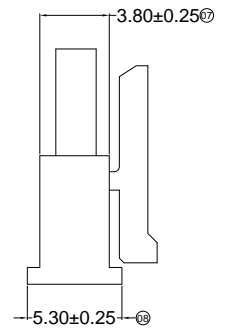
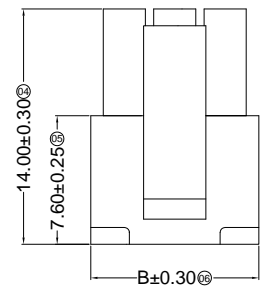

Poles	Dimensions (mm)		Poles	Dimensions (mm)	
	A	B		A	B
03	6.00	9.85	08	21.00	24.85
04	9.00	12.85	09	24.00	27.85
05	12.00	15.85	10	27.00	30.85
06	15.00	18.85	11	30.00	33.85
07	18.00	21.85	12	33.00	36.85

X3025HM-XX-N2	Nylon 66 94V-2	X3025TF	X3025W
PART NO	Material	Suitable XKB Terminal	Mates With XKB Wafer

For and on behalf of
XKB INDUSTRIAL PRECISION CO., LIMITED
 香港星坤工業精密有限公司

△ X					ANGULAR	±5°
△ X					L ≤ 4	±0.2
△ X					4 < L ≤ 16	±0.3
△ X					16 < L ≤ 63	±0.4
MARK	DESCRIPTION	DATE	REVISED	APPROVED	L > 63	±0.5
	REVISIONS				UNSPECIFIED TOLERANCES	

DSND	DATE	SCALE: N/A	MODEL TYPE:
DWN	DATE	VIEW:	X3025HM-XX-N2
CHKD	DATE	UNIT: mm	PART NO.:
APPD	DATE	SIZE: A4	3.00 mm Crimp Style Connectors
			DWG NO.:
			WEIGHT
			1.0g
			SHEET
			1/1
			REVISION
			A0

XKB INDUSTRIAL PRECISION CO., LIMITED

1 2 3 4 5 6 7 8

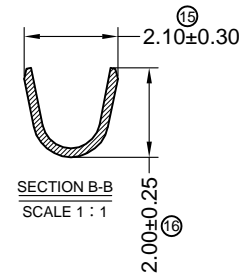
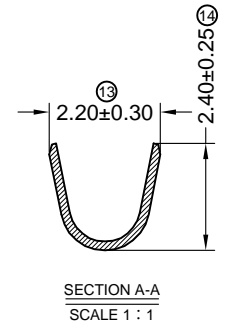
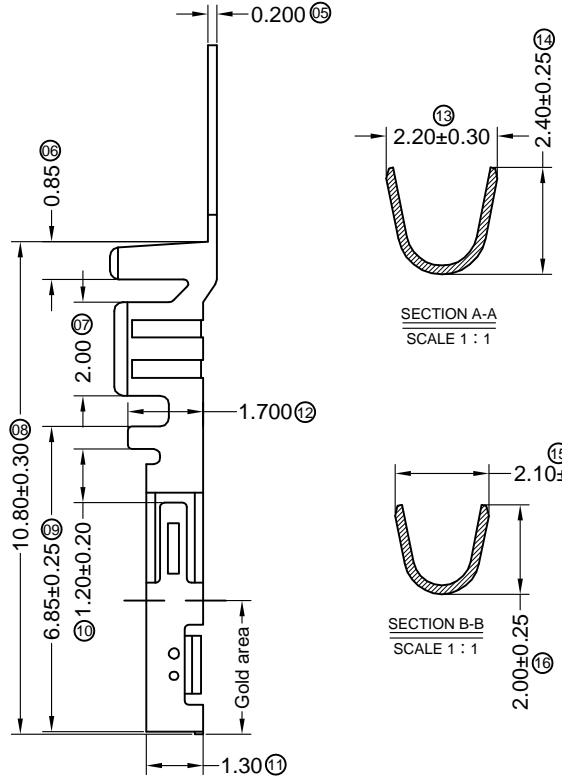
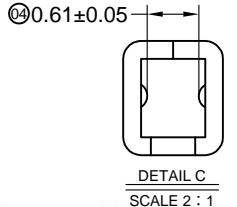
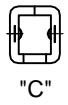
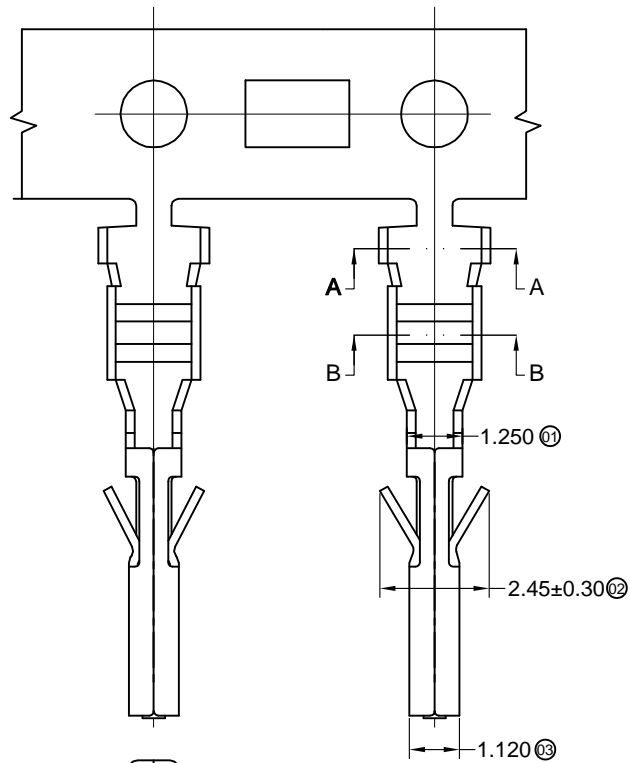

- Specifications :**
- Voltage rating: 250V AC / DC
 - Current rating: 5A AC / DC
 - Withstanding voltage: 1000V AC/minute
 - Temperature range: -40°C~+85°C
 - Insulation resistance: ≥1000MΩ
 - Contact resistance: ≤10mΩ
 - After environmental testing: ≤20mΩ

X3025 T F-P XX X-X

- (1) Series Number
- (2) Category: T-terminal
- (3) Shape: F-Female Terminal
- (4) Material: P-Phosphor bronze
- (5) Plating style:
G-Gold-Plated Contact
*01-Gold Flash *15-15u" *30-30u"
SN-Bright tin plating 70-120u"
- (6) Plating method:
Blank-Stamping before plating
- (7) Mold No./Mark/Special No.

X3025TF-PG30	Phosphor Bronze	AWG#20-24	1.85mm(Max)	Stamping Before Pating:30~50u" Ni;Contact Area Gold:30u" Min.	X3025HM
X3025TF-PG15				Stamping Before Pating:30~50u" Ni;Contact Area Gold:15u" Min.	
X3025TF-PG01				Stamping Before Pating:30~50u" Ni;Contact Area Gold Flash	
X3025TF-PSN				Stamping Before Plating:30~50u" Ni;70~120u" Sn	
PART NO	Material	Wire Range	Insulation O.D.	Finish	Used In XKB Housing

For and on behalf of
XKB INDUSTRIAL PRECISION CO., LIMITED
香港星坤工業精密有限公司

△ X						ANGULAR	±5°
△ X						L ≤ 4	±0.2
△ X						4 < L ≤ 16	±0.3
△ X						16 < L ≤ 63	±0.4
MARK						L > 63	±0.5
REVISIONS				UNSPECIFIED TOLERANCES			

DSND		DATE		SCALE: N/A	MODEL TYPE: X3025TF-PXXX
DWN		DATE		VIEW:	PART NO.:
CHKD		DATE		UNIT: mm	3.00 mm Crimp Style Connectors
APPD		DATE		SIZE: A4	DWG NO.:
Authorized Signature(s)				XKB INDUSTRIAL PRECISION CO., LIMITED	WEIGHT 1.0g
					SHEET 1/1
					REVISION A0

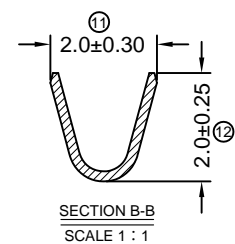
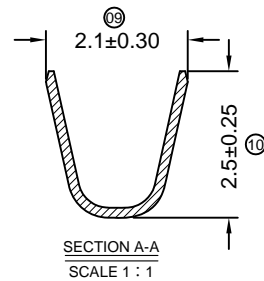
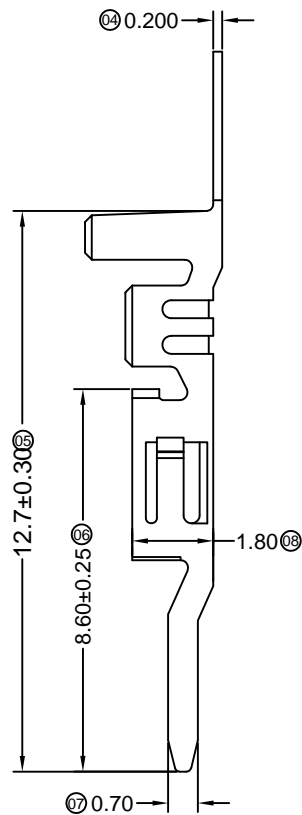
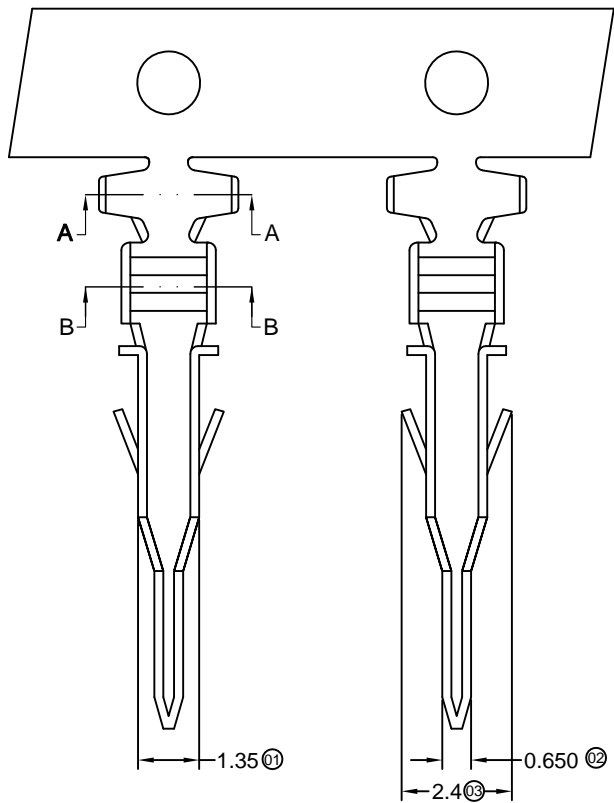

■ Specifications :

- Voltage rating: 250V AC / DC
- Current rating: 5A AC / DC
- Withstanding voltage: 1000V AC/minute
- Temperature range: -25°C~+85°C
- Insulation resistance: ≥1000MΩ
- Contact resistance: ≤10mΩ
- After environmental testing: ≤20mΩ

X3025 T M-P XX X-X

(11) (12) (13) (14) (15) (16) (17)

- (11) Series Number
- (12) Category: T-terminal
- (13) Shape: M-Male Terminal
- (14) Material: P-Phosphor bronze
- (15) Plating style:
G-Gold-Plated Contact
*01-Gold Flash *15-15u" *30-30u"
SN-Bright tin plating 70u"
- (16) Plating method:
Blank-Stamping before plating
- (17) Mold No./Mark/Special No.

X3025TM-PG30				Stamping Before Pating:30u" Ni;Contact Area Gold:30u" Min.	X3025HF
X3025TM-PG15	Phosphor Bronze	AWG#20-24	1.85mm(Max)	Stamping Before Pating:30u" Ni;Contact Area Gold:15u" Min.	
X3025TM-PG01				Stamping Before Pating:30u" Ni;Contact Area Gold Flash	
X3025TM-PSN				Stamping Before Pating:30u" Ni;70u"Sn	
PART NO	Material	Wire Range	Insulation O.D.	Finish	Used In XKB Housing

For and on behalf of
XKB INDUSTRIAL PRECISION CO., LIMITED
香港星坤工業精密有限公司

					DSND		DATE		SCALE: N/A	MODEL TYPE: X3025TM-PXX		
△ X					ANGULAR	± 5°	DWN		VIEW:	PART NO.:		
△ X					L ≤ 4	± 0.2	CHKD		UNIT: mm	3.00 mm Crimp Style Connectors		
△ X					4 < L ≤ 16	± 0.3	APPD		SIZE: A4	DWG NO.:		
MARK	DESCRIPTION	DATE	REVISED	APPROVED	16 < L ≤ 63	± 0.4						
					L > 63	± 0.5						
					UNSPECIFIED TOLERANCES	XKB INDUSTRIAL PRECISION CO., LIMITED				WEIGHT 1.0g	SHEET 1/1	REVISION A0

REVISIONS
 Authorized Signature(s)

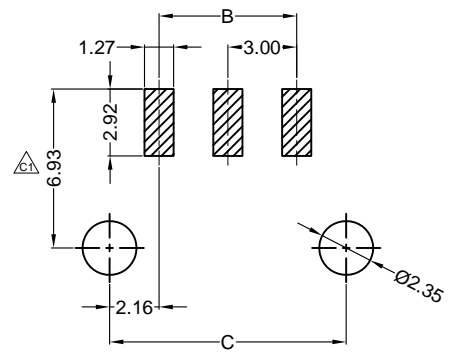
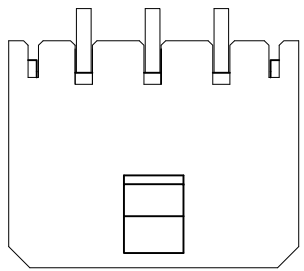

P.C.B. LAYOUT

- Specifications :
- Voltage rating: 250V AC / DC
 - Current rating: 5A AC / DC
 - Withstanding voltage: 1000V AC/minute
 - Temperature range: -25°C~+85°C
 - Insulation resistance: ≥1000MΩ
 - Contact resistance: ≤10mΩ
 - After environmental testing: ≤20mΩ

Poles	Dimensions (mm)		
	A	B	C
02	6.85	3.00	7.30
03	9.85	6.00	10.30
04	12.85	9.00	13.30
05	15.85	12.00	16.30
06	18.85	15.00	19.30
07	21.85	18.00	22.30
08	24.85	21.00	25.30
09	27.85	24.00	28.30
10	30.85	27.00	31.30
11	33.85	30.00	34.30
12	36.85	33.00	37.30

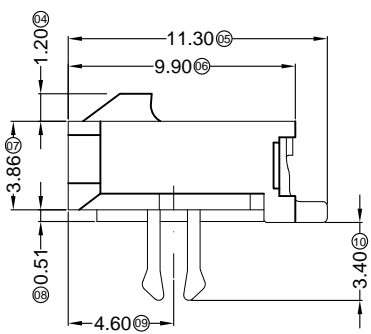
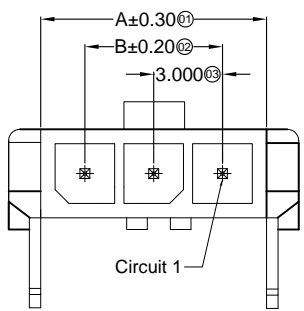
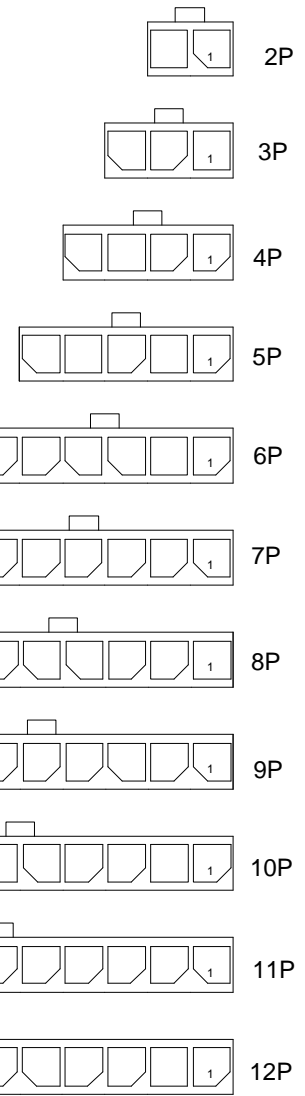

X3025 W R S- XX C-XX XX XX

- ① Series No.
- ② Category: W-wafer
- ③ Welding Board Angle: R-90°
- ④ Welding Way: S-SMT
- ⑤ Row No.-Pin No. : XX-Single row
- ⑥ Special NO.: C-The harpoon
- ⑦ Material: LP-LCP 94V-0 66-PA66 94V-0
- ⑧ Planting Category:
SN-Bright tin plating 70U"
SW-Fog Tin plating
- ⑨ Color: Blank-natural color

3025WRS-XXC-LPSW	LCP UL 94V-0	Brass	Tin Plating Fog	Brass	Tin-Plated	X3025H
3025WRS-XXC-LPSN	LCP UL 94V-0		Tin-Plated			
3025WRS-XXC-66SN	PA66 UL 94V-0					
PART NO	Material	Material(Pin)	Finish(Pin)	Material (Solder Tabs)	Finish (Solder Tabs)	Mates With XKB Housing

For and on behalf of
XKB INDUSTRIAL PRECISION CO., LIMITED
 香港星坤工業精密有限公司

REVISIONS
 Authorized Signature(s)

DSND	DATE	SCALE: N/A	MODEL TYPE: X3025WRS-XXC-XXXX
DWN	DATE	VIEW:	PART NO.:
CHKD	DATE	UNIT: mm	3.00 mm Crimp Style Connectors
APPD	DATE	SIZE: A4	DWG NO.:
			WEIGHT 1.0g
			SHEET 1/1
			REVISION A0

XKB INDUSTRIAL PRECISION CO., LIMITED

MARK	DESCRIPTION	DATE	REVISED	APPROVED	UNSPECIFIED TOLERANCES
△ X					ANGULAR ±5°
△ X					L ≤ 4 ±0.2
△ X					4 < L ≤ 16 ±0.3
					16 < L ≤ 63 ±0.4
					L > 63 ±0.5

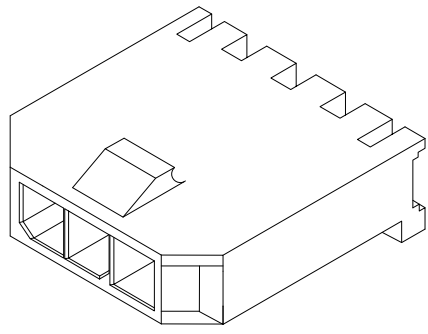
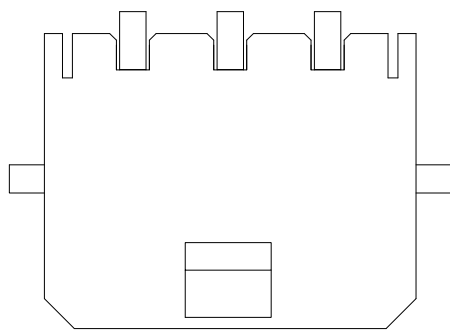

Specifications :

- Voltage rating: 250V AC / DC
- Current rating: 5A AC / DC
- Withstanding voltage: 1000V AC/minute
- Temperature range: -25°C~+85°C
- Insulation resistance: ≥1000MΩ
- Contact resistance: ≤10mΩ
- After environmental testing: ≤20mΩ
- Mark "*" Indicate Dimensions Need To Controlled In Emphasis

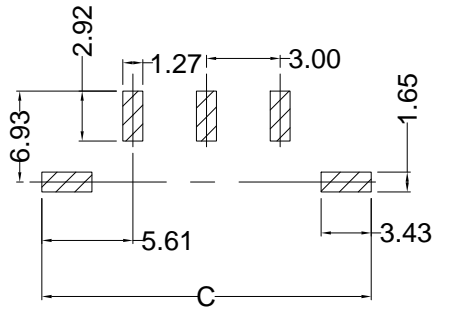
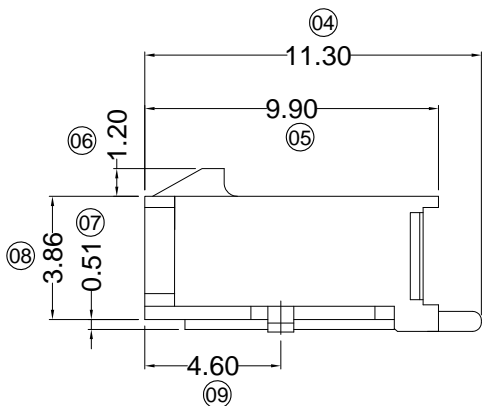
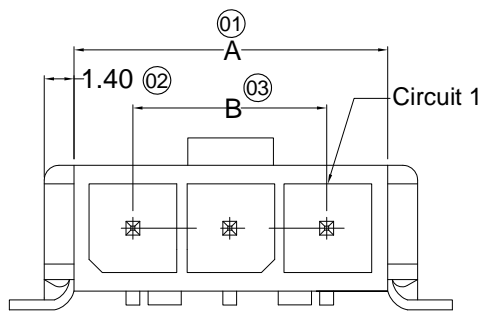

P.C.B. LAYOUT

X3025 W R S- XX D-LP SW XX

①②③④ ⑤⑥⑦⑧⑨

- ① Series No.
- ② Category:
W-wafer
- ③ Welding Board Angle:
R-90°
- ④ Welding Way:
S-SMT
- ⑤ Row No.-Pin No.
XX-Single row
- ⑥ Special NO.
D-Solder Tabs
- ⑦ Material:
LP-LCP 94V-0
- ⑧ Planting Category:
V** : All Gold-Plated
G** : Gold-Plated Contact
*01-Gold Flash ; *02-2U" ; *03-3U" ; *05-5U"
*10-10U" ; *15-15U" ; *30-30U" ; *50-50U"
SN-Bright tin plating 70U"
SN1-Bright tin plating 120U" Min. ;
SW-Fog Tin plating
- ⑨ Color:
Blank-natural color

Poles	Dimensions		
	A	B	C
2	6.85	3.00	14.20
3	9.85	6.00	17.20
4	12.85	9.00	20.20
5	15.85	12.00	23.20
6	18.85	15.00	26.20
7	21.85	18.00	29.20
8	24.85	21.00	32.20
9	27.85	24.00	35.20
10	30.85	27.00	38.20
11	33.85	30.00	41.20
12	36.85	33.00	44.20

X3025WRS-XXD-LPG15	LCP UL 94V-0	Brass	Contact Area Gold: 15u" Min.	Brass	Tin-Plated	X3025H
X3025WRS-XXD-LPSW	LCP UL 94V-0	Brass	Tin Plating Fog	Brass	Tin-Plated	X3025H
PART NO	Material	Material(Pin)	Finish(Pin)	Material (Solder Tabs)	Finish (Solder Tabs)	Mates With XKB Housing

For and on behalf of
XKB INDUSTRIAL PRECISION CO., LIMITED
 香港星坤工業精密有限公司

MARK	DESCRIPTION	DATE	REVISED	APPROVED	UNSPECIFIED TOLERANCES
△ X					ANGULAR ±5°
△ X					L ≤ 4 ±0.2
△ X					4 < L ≤ 16 ±0.3
△ X					16 < L ≤ 63 ±0.4
△ X					L > 63 ±0.5

DSND	DATE	SCALE: N/A	MODEL TYPE:
DWN	DATE	VIEW:	X3025WRS-XXD-LPXXX
CHKD	DATE	UNIT: mm	PART NO.:
APPD	DATE	SIZE: A4	3.00 mm Crimp Style Connectors
			DWG NO.:
		WEIGHT	SHEET
		1.0g	1/1
		REVISION	A0

REVISIONS
 Authorized Signature(s)

XKB INDUSTRIAL PRECISION CO., LIMITED

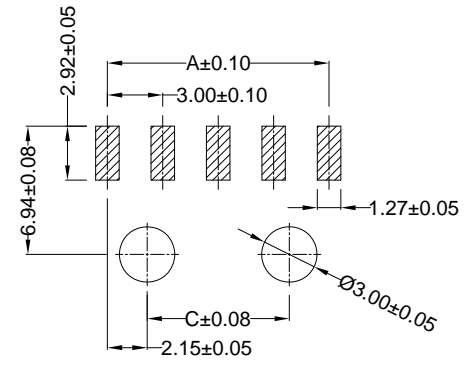
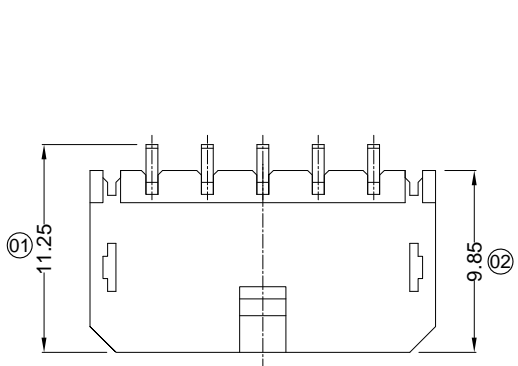

Recommended P.C.B Board Layout

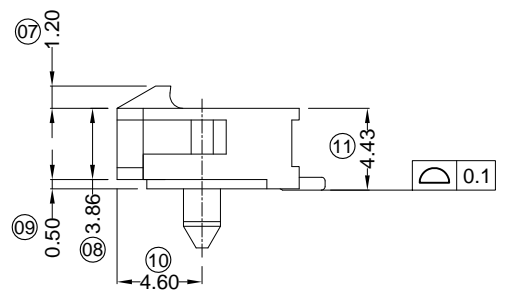
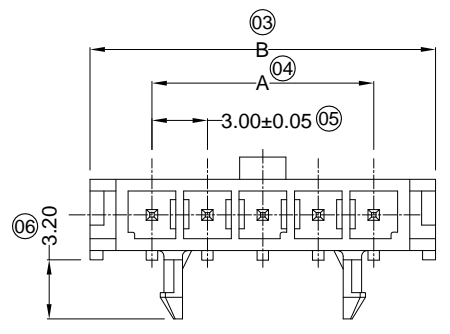

- Specifications :
- Voltage rating: 250V AC / DC
 - Current rating: 5A AC / DC
 - Withstanding voltage: 1000V AC/minute
 - Temperature range: -25°C~+85°C
 - Insulation resistance: ≥1000MΩ
 - Contact resistance: ≤10mΩ
 - After environmental testing: ≤20mΩ

X3025 W R S-XX E-LP XX XX
 ① ② ③ ④ ⑤ ⑥ ⑦ ⑧ ⑨

- ① Series No.
- ② Category:
W-wafer
- ③ Welding Board Angle:
R-90°
- ④ Welding Way:
S-SMT
- ⑤ Row No.-Pin No.
XX-Single row
- ⑥ Special NO.
E-With plastic positioning column
- ⑦ Material:
LP-LCP 94V-0
- ⑧ Planting Category:
V**:All Gold-Plated
G**:Gold-Plated Contact
*01-Gold Flash ; *02-2u" ; *03-3u" ; *05-5u"
*10-10u" ; *15-15u" ; *30-30u" ; *50-50u"
SN-Bright tin plating 70u"
SN1-Bright tin plating 120u"Min. ;
SW-Fog Tin plating
- ⑨ Color:
Blank-natural color

Poles	Dimensions (mm)		
	A	B	C
02	3.00	9.65	---
03	6.00	12.65	---
04	9.00	15.65	4.70
05	12.00	18.65	7.70
06	15.00	21.65	10.70
07	18.00	24.65	13.70
08	21.00	27.65	16.70
09	24.00	30.65	19.70
10	27.00	33.65	22.70
11	30.00	36.65	25.70
12	33.00	39.65	28.70

X3025WRS-XXE-LPSW	LCP UL 94V-0	Brass	Tin Plating Fog	X3025H
X3025WRS-XXE-LPSN			Tin-Plated	
PART NO	Material	Material(Pin)	Finish(Pin)	Mates With XKB Housing

For and on behalf of
XKB INDUSTRIAL PRECISION CO., LIMITED
香港星坤工業精密有限公司

△ X	DESCRIPTION	DATE	REVISED	APPROVED	UNSPECIFIED TOLERANCES	DSND	DATE	SCALE: N/A	MODEL TYPE: X3025WRS-XXE-LPXX		
△ X						DWN	DATE	VIEW:	PART NO.:		
△ X						CHKD	DATE	UNIT: mm	3.00 mm Crimp Style Connectors		
MARK						APPD	DATE	SIZE: A4	DWG NO.:		
REVISIONS						XKB INDUSTRIAL PRECISION CO., LIMITED			WEIGHT	SHEET	REVISION
									1.0g	1/1	A0

Authorized Signature(s)

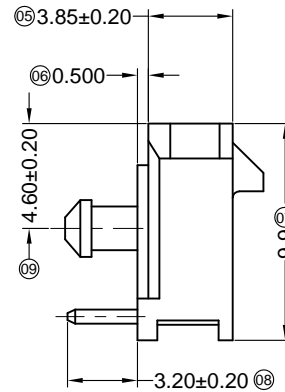
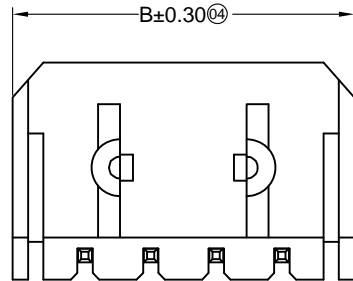
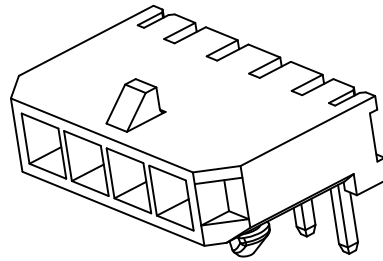
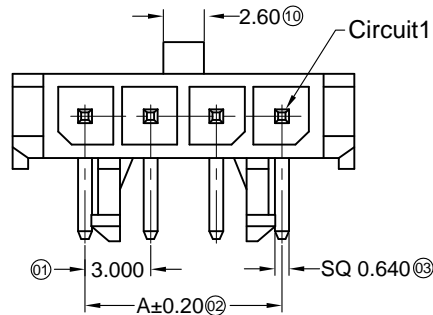

Specifications :

- Voltage rating: 250V AC / DC
- Current rating: 5A AC / DC
- Withstanding voltage: 1500V AC/minute
- Temperature range: -40°C~+105°C
- Insulation resistance: ≥1000MΩ
- Contact resistance: ≤10mΩ
- After environmental testing: ≤20mΩ

X3025 W R X - XX X - XX SN XX
 (01) (02) (03) (04) (05) (06) (07) (08) (09)

- (01) Series No.
- (02) Category: W-wafer
- (03) Welding Board Angle: R-90°
- (04) Welding Way: Blank-DIP
- (05) Row No.-Pin No.: XX-Single row
- (06) Plug the Pin & Special No.:
- (07) Material:
LP-LCP 94V-0 N0-PA9T 94V-0
- (08) Planting Category:
SN-Bright tin plating 70u" Min.
- (09) Color: Blank-Natural Color Black

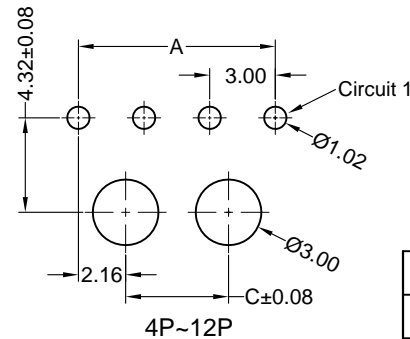
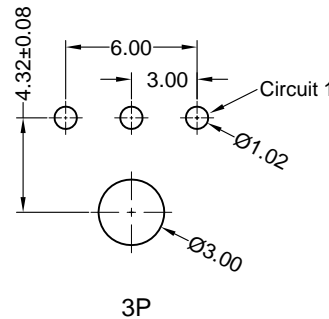
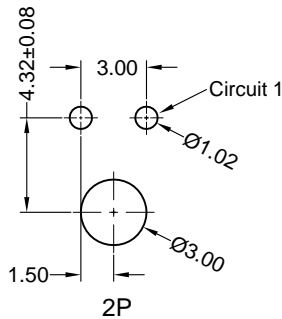

Recommended P.C.B Layout
 General Tolerance±0.05

Poles	Dimensions(mm)			Poles	Dimensions(mm)		
	A	B	C		A	B	C
01	---	6.65	---	07	18.00	24.65	13.70
02	3.00	9.65	---	08	21.00	27.65	16.70
03	6.00	12.65	---	09	24.00	30.65	19.70
04	9.00	15.65	4.70	10	27.00	33.65	22.70
05	12.00	18.65	7.70	11	30.00	36.65	25.70
06	15.00	21.65	10.70	12	33.00	39.65	28.70

X3025WR-XX-N0SNXX	PA9T UL 94V-0	Brass	Tin-Plated	X3025H
X3025WR-XX-LPSNXX	LCP UL 94V-0			
PART NO	Material	Material(Pin)	Finish(Pin)	Mates With XKB Housing

For and on behalf of
XKB INDUSTRIAL PRECISION CO., LIMITED
香港星坤工業精密有限公司

MARK	DESCRIPTION	DATE	REVISED	APPROVED	UNSPECIFIED TOLERANCES
△ X					ANGULAR ±5°
△ X					L ≤ 4 ±0.2
△ X					4 < L ≤ 16 ±0.3
					16 < L ≤ 63 ±0.4
					L > 63 ±0.5

DSND		DATE	SCALE: N/A	MODEL TYPE: X3025WR-XX-XXSNXX
DWN		DATE	VIEW:	PART NO.:
CHKD		DATE	UNIT: mm	3.00mm Crimp Style Connectors
APPD		DATE	SIZE: A4	DWG NO.:
				WEIGHT 1.0g
				SHEET 1/1
				REVISION A0

REVISIONS
 Authorized Signature(s)

XKB INDUSTRIAL PRECISION CO., LIMITED

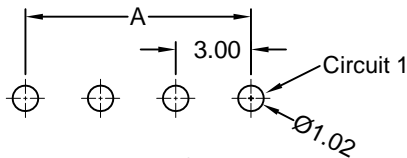
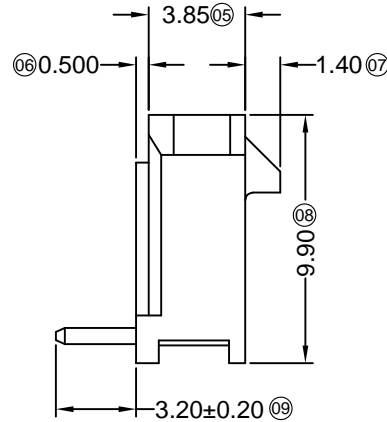
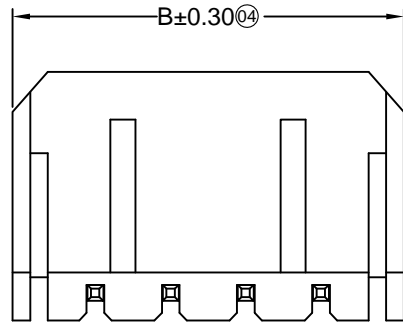
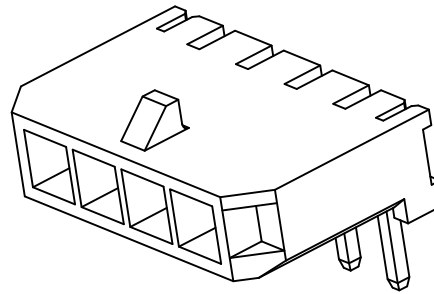
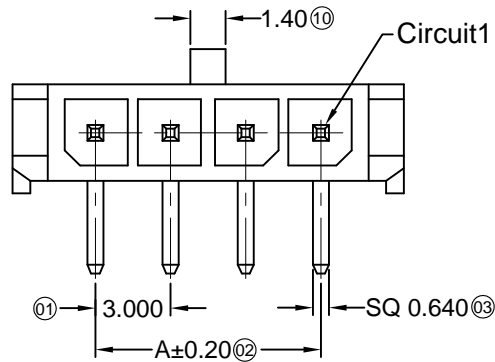

Recommended P.C.B Layout
General Tolerance±0.05

Specifications :

- Voltage rating: 250V AC / DC
- Current rating: 5A AC / DC
- Withstanding voltage:1500V AC/minute
- Temperature range: -40°C~+105°C
- Insulation resistance:≥1000MΩ
- Contact resistance: ≤10mΩ
- After environmental testing: ≤20mΩ

X3025 W R X - XX B - XX SN XX
① ② ③ ④ ⑤ ⑥ ⑦ ⑧ ⑨

- ① Series No.
- ② Category: W-wafer
- ③ Welding Board Angle: R-90°
- ④ Welding Way: Blank-DIP
- ⑤ Row No.-Pin No.: XX-01P~12P
- ⑥ Plug the Pin & Special No.:
B-Without positioning column
- ⑦ Material: LP-LCP 94V-0 ;
66-PA66 94V-0
- ⑧ Planting Category: SN-Bright tin plating
- ⑨ Color: Blank-Natural Color Black

Poles	Dimensions(mm)		Poles	Dimensions(mm)	
	A	B		A	B
01	---	6.65	07	18.00	24.65
02	3.00	9.65	08	21.00	27.65
03	6.00	12.65	09	24.00	30.65
04	9.00	15.65	10	27.00	33.65
05	12.00	18.65	11	30.00	36.65
06	15.00	21.65	12	33.00	39.65

X3025WR-XXB-66SN	PA66 UL 94V-0	Brass	Tin-Plated	X3025H
X3025WR-XXB-LPSN	LCP UL 94V-0			
PART NO	Material	Material(Pin)	Finish(Pin)	Mates With XKB Housing

For and on behalf of
XKB INDUSTRIAL PRECISION CO., LIMITED
香港星坤工業精密有限公司

MARK	DESCRIPTION	DATE	REVISED	APPROVED	UNSPECIFIED TOLERANCES
△ X					ANGULAR ±5°
△ X					L ≤ 4 ±0.2
△ X					4 < L ≤ 16 ±0.3
					16 < L ≤ 63 ±0.4
					L > 63 ±0.5

DSND		DATE		SCALE: N/A	MODEL TYPE: X3025WR-XXB-XXSN
DWN		DATE		VIEW:	PART NO.: 3.00mm Crimp Style Connectors
CHKD		DATE		UNIT: mm	DWG NO.:
APPD		DATE		SIZE: A4	
				WEIGHT	SHEET
				1.0g	1/1
				REVISION	A0

Authorized Signature(s)

XKB INDUSTRIAL PRECISION CO., LIMITED

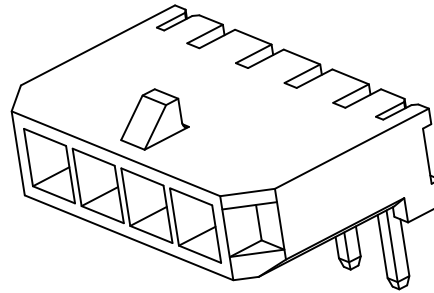
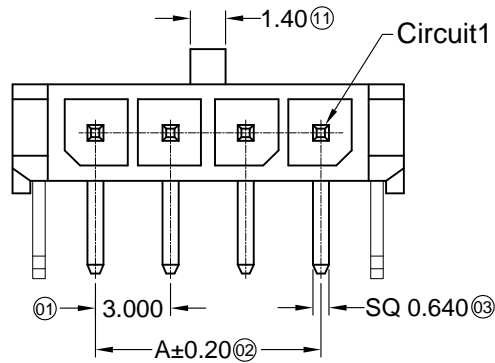

Specifications :

- Voltage rating: 250V AC / DC
- Current rating: 5A AC / DC
- Withstanding voltage: 1500V AC/minute
- Temperature range: -40°C~+105°C
- Insulation resistance: ≥1000MΩ
- Contact resistance: ≤10mΩ
- After environmental testing: ≤20mΩ

X3025 W R X - XX C - XX SN XX
 ① ② ③ ④ ⑤ ⑥ ⑦ ⑧ ⑨

- ① Series No.
- ② Category: W-wafer
- ③ Welding Board Angle: R-90°
- ④ Welding Way: Blank-DIP
- ⑤ Row No.-Pin No.: XX-01P~12P
- ⑥ Plug the Pin & Special No.: C-The harpoon
- ⑦ Material: LP-LCP 94V-0 ; 66-PA66 94V-0
- ⑧ Planting Category: SN-Bright tin plating
- ⑨ Color: Blank-Natural Color Black

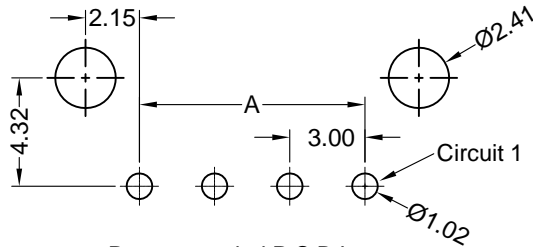
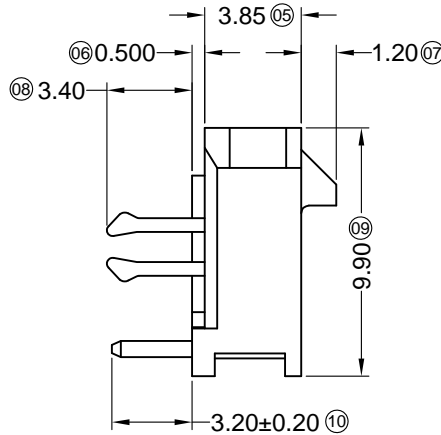
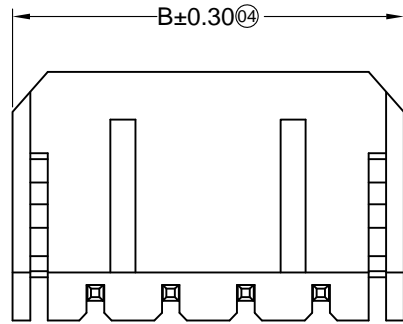

Recommended P.C.B Layout
 General Tolerance±0.05

Poles	Dimensions(mm)		Poles	Dimensions(mm)	
	A	B		A	B
01	---	6.65	07	18.00	24.65
02	3.00	9.65	08	21.00	27.65
03	6.00	12.65	09	24.00	30.65
04	9.00	15.65	10	27.00	33.65
05	12.00	18.65	11	30.00	36.65
06	15.00	21.65	12	33.00	39.65

X3025WR-XXC-66SN	PA66 UL 94V-0	Brass	Tin-Plated	X3025H
X3025WR-XXC-LPSN	LCP UL 94V-0			
PART NO	Material	Material(Pin)	Finish(Pin)	Mates WithXKB Housing

For and on behalf of
XKB INDUSTRIAL PRECISION CO., LIMITED
 香港星坤工業精密有限公司

DSND	DATE	SCALE: N/A	MODEL TYPE: X3025WR-XXC-XXSN
DWN	DATE	VIEW:	PART NO.:
CHKD	DATE	UNIT: mm	3.00mm Crimp Style Connectors
APPD	DATE	SIZE: A4	DWG NO.:
			WEIGHT
			1.0g
			SHEET
			1/1
			REVISION
			A0

MARK	DESCRIPTION	DATE	REVISED	APPROVED	UNSPECIFIED TOLERANCES
△ X					ANGULAR ±5°
△ X					L ≤ 4 ±0.2
△ X					4 < L ≤ 16 ±0.3
△ X					16 < L ≤ 63 ±0.4
△ X					L > 63 ±0.5

Authorized Signature(s)

XKB INDUSTRIAL PRECISION CO., LIMITED

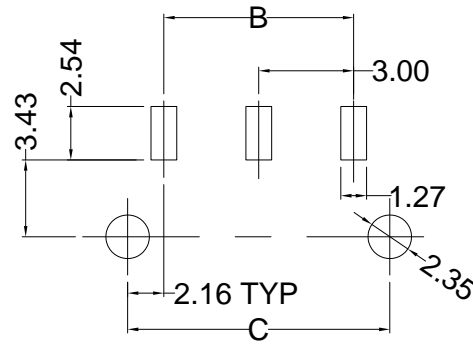
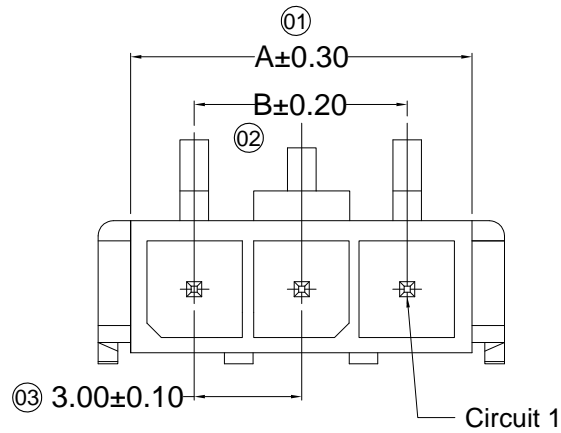

P.C.B. LAYOUT

Specifications :

- Voltage rating: 250V AC / DC
- Current rating: 5A AC / DC
- Withstanding voltage: 1000V AC/minute
- Temperature range: -25°C~+85°C
- Insulation resistance: ≥1000MΩ
- Contact resistance: ≤10mΩ
- After environmental testing: ≤20mΩ
- Mark "*" Indicate Dimensions Need to Controlled In Emphasis

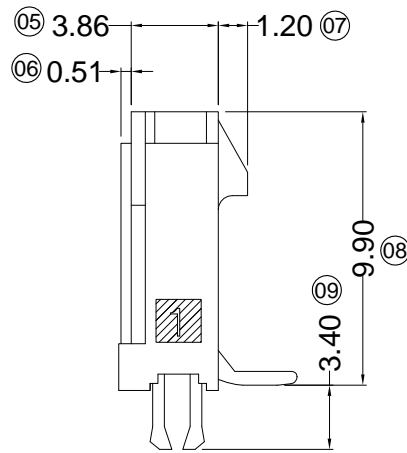
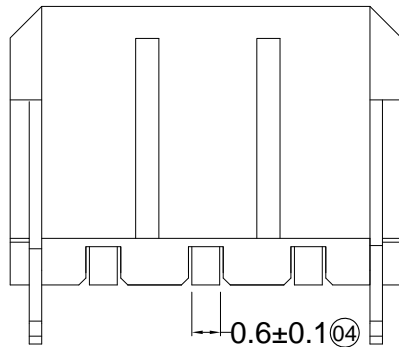

X3025 W V S- XX C-XX XX XX

- ① Series No.
- ② Category: W-wafer
- ③ Welding Board Angle: V-180°
- ④ Welding Way: S-SMT
- ⑤ Row No.-Pin No. XX-Single row
- ⑥ Special NO. C-The harpoon
- ⑦ Material: LP-LCP 94V-0 66-PA66 94V-0
- ⑧ Planting Category: V** :All Gold-Plated G** :Gold-Plated Contact *01-Gold Flash ; *02-2U" ; *03-3U" ; *05-5U" *10-10U" ; *15-15U" ; *30-30U" ; *50-50U" SN1-Bright tin plating 70U" SN1-Bright tin plating 120U"Min. ; SW-Fog Tin plating
- ⑨ Color: Blank-natural color

Poles	Dimensions (mm)		
	A	B	C
02	6.85	3.00	7.30
03	9.85	6.00	10.30
04	12.85	9.00	13.30
05	15.85	12.00	16.30
06	18.85	15.00	19.30
07	21.85	18.00	22.30
08	24.85	21.00	25.30
09	27.85	24.00	28.30
10	30.85	27.00	31.30
11	33.85	30.00	34.30
12	36.85	33.00	37.30

X3025WVS-XXC-LPSW	LCP UL 94V-0	Brass	Tin Plating Fog	Brass	Tin-Plated	X3025H
X3025WVS-XXC-66SN	PA66 UL 94V-0	Brass	Tin-Plated	Brass	Tin-Plated	X3025H
PART NO	Material	Material(Pin)	Finish(Pin)	Material (Solder Tabs)	Finish (Solder Tabs)	Mates With XKB Housing

For and on behalf of
XKB INDUSTRIAL PRECISION CO., LIMITED
 香港星坤工業精密有限公司

MARK	DESCRIPTION	DATE	REVISED	APPROVED	UNSPECIFIED TOLERANCES	DSND	DATE	SCALE: N/A	MODEL TYPE: X3025WVS-XXC-XXXX
△ X					ANGULAR ±5°	DWN	DATE	VIEW:	PART NO.:
△ X					L ≤ 4 ±0.2	CHKD	DATE	UNIT: mm	3.00 mm Crimp Style Connectors
△ X					4 < L ≤ 16 ±0.3	APPD	DATE	SIZE: A4	DWG NO.:
△ X					16 < L ≤ 63 ±0.4				
△ X					L > 63 ±0.5				
REVISIONS						XKB INDUSTRIAL PRECISION CO., LIMITED			
Authorized Signature(s)						WEIGHT	SHEET	REVISION	
						1.0g	1/1	A0	

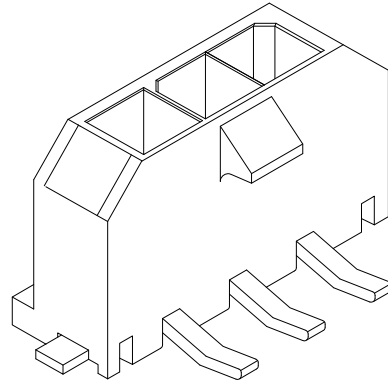
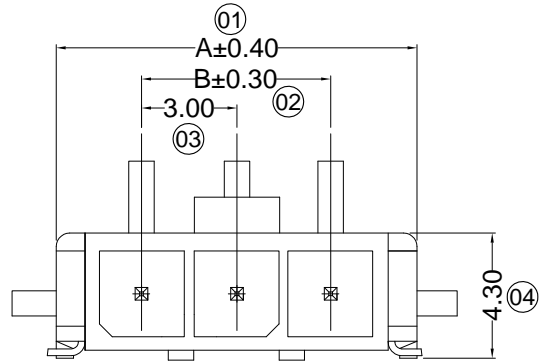

Specifications :

- Voltage rating: 250V AC / DC
- Current rating: 5A AC / DC
- Withstanding voltage: 1000V AC/minute
- Temperature range: -25°C~+85°C
- Insulation resistance: ≥1000MΩ
- Contact resistance: ≤10mΩ
- After environmental testing: ≤20mΩ
- Mark "*" Indicate Dimensions Need To Controlled In Emphasis

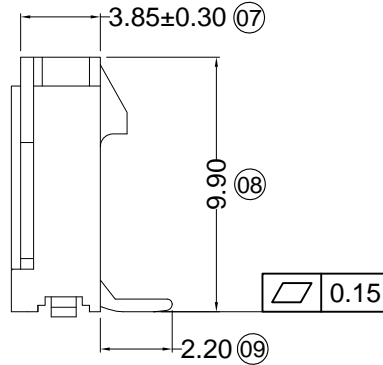
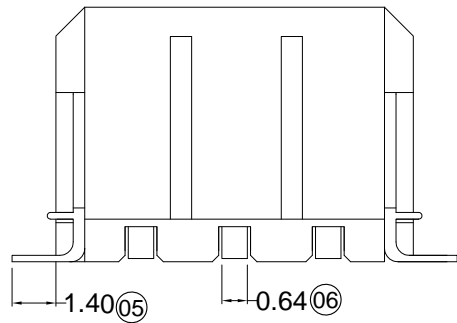

X3025 W V S- XX D-LP XX XX

01 02 03 04 05 06 07 08 09

- 01 Series No.
- 02 Category: W-wafer
- 03 Welding Board Angle: V-180°
- 04 Welding Way: S-SMT
- 05 Row No.-Pin No. XX-Single row
- 06 Special NO. D-Solder Tabs
- 07 Material: LP-LCP 94V-0
- 08 Planting Category: V**:All Gold-Plated; G**:Gold-Plated Contact; *01-Gold Flash ; *02-2U" ; *03-3U" ; *05-5U" ; *10-10U" ; *15-15U" ; *30-30U" ; *50-50U"
- 09 Color: SN1-Bright tin plating 70U" ; SW-Fog Tin plating ; Blank-natural color

Poles	Dimensions(mm)		
	A	B	C
02	9.70	3.00	12.50
03	12.70	6.00	15.50
04	15.70	9.00	18.50
05	18.70	12.00	21.50
06	21.70	15.00	24.50
07	24.70	18.00	27.50
08	27.70	21.00	30.50
09	30.70	24.00	33.50
10	33.70	27.00	36.50
11	36.70	30.00	39.50
12	39.70	33.00	42.50

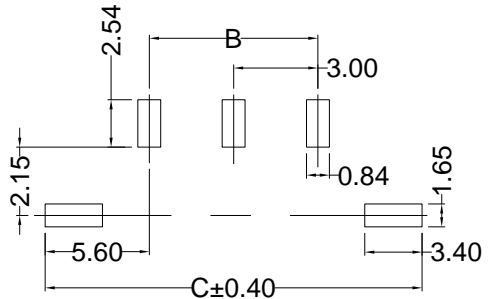

P.C.B. LAYOUT

X3025WVS-XXD-LPSW	LCP UL 94V-0	Brass	Tin Plated Fog	Brass	Tin Plated Fog	Mates With XKB5.70] Housing
X3025WVS-XXD-LPSN	LCP UL 94V-0		Tin-Plated		Tin-Plated	
PART NO	Material	Material(Pin)	Finish(Pin)	Material (Solder Tabs)	Finish (Solder Tabs)	

For and on behalf of
XKB INDUSTRIAL PRECISION CO., LIMITED
 香港星坤工業精密有限公司

Authorized Signature(s)

DSND	DATE	SCALE: N/A	MODEL TYPE: X3025WVS-XXD-LPXX
DWN	DATE	VIEW:	PART NO.:
CHKD	DATE	UNIT: mm	3.00 mm Crimp Style Connectors
APPD	DATE	SIZE: A4	DWG NO.:
			WEIGHT: 1.0g
			SHEET: 1/1
			REVISION: A0

△ X	DESCRIPTION	DATE	REVISED	APPROVED	UNSPECIFIED TOLERANCES
△ X					
△ X					
MARK					

ANGULAR	± 5°
L ≤ 4	± 0.2
4 < L ≤ 16	± 0.3
16 < L ≤ 63	± 0.4
L > 63	± 0.5

XKB INDUSTRIAL PRECISION CO., LIMITED

1 2 3 4 5 6 7 8

A
B
C
D
E
F

A
B
C
D
E
F

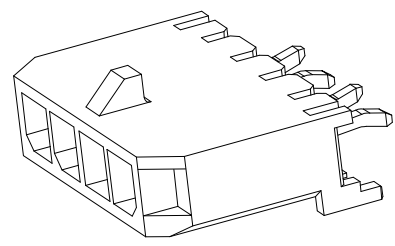
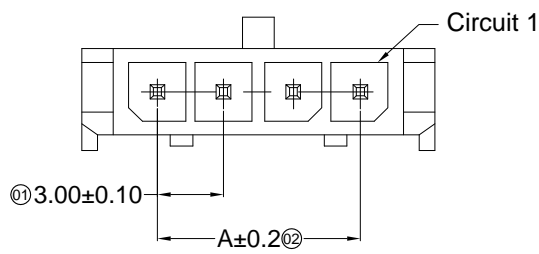

■ Specifications :

- Voltage rating: 250V AC / DC
- Current rating: 5A AC / DC
- Withstanding voltage: 1500V AC/minute
- Temperature range: -25°C~+85°C
- Insulation resistance: ≥1000MΩ
- Contact resistance: ≤10mΩ
- After environmental testing: ≤20mΩ

X3025 W V X-XX X- XX SN XX

① ② ③ ④ ⑤ ⑥ ⑦ ⑧ ⑨

- ① Series No.
- ② Category: W-wafer
- ③ Welding Board Angle: V- Straight 180°
- ④ Welding Way: Blank-DIP
- ⑤ Row No.-Pin No.: XX-02P~12P
- ⑥ Plug the Pin & Special No.:
- ⑦ Material: 46-PA46 94V-0 ; PT-PBT 94V-0; 66-PA66 94V-0
- ⑧ Planting Category: SN-Bright tin plating
- ⑨ Color: Blank-Natural Color

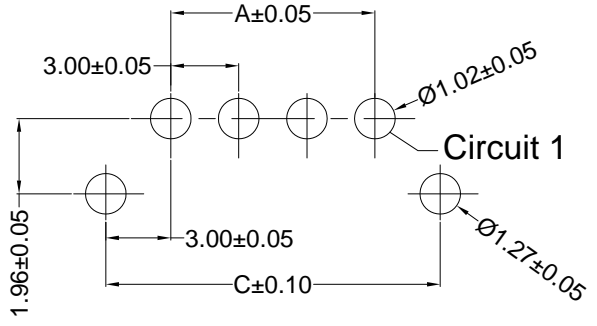
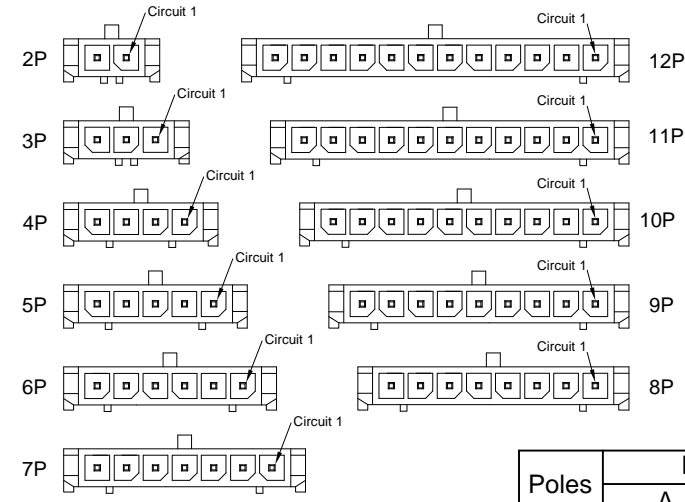
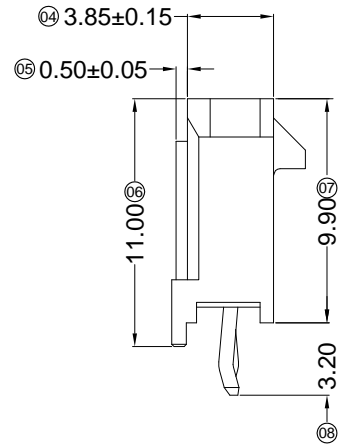
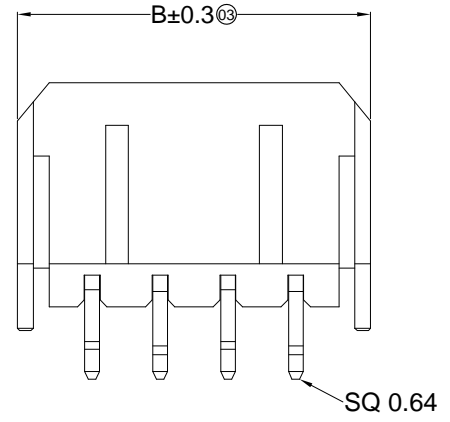

P.C.B LAYOUT

X3025WV-XX-66SN	PA66 UL 94V-0	Brass	Tin-Plated	X3025H
X3025WV-XX-46SN	PA46 UL 94V-0			
X3025WV-XX-PTS	PBT UL 94V-0			
PART NO	Material	Material(Pin)	Finish(Pin)	Mates With XKB Housing

Poles	Dimensions(mm)		
	A	B	C
02	3.00	9.65	9.00
03	6.00	12.65	12.00
04	9.00	15.65	15.00
05	12.00	18.65	18.00
06	15.00	21.65	21.00
07	18.00	24.65	24.00
08	21.00	27.65	27.00
09	24.00	30.65	30.00
10	27.00	33.65	33.00
11	30.00	36.65	36.00
12	33.00	39.65	39.00

For and on behalf of
XKB INDUSTRIAL PRECISION CO., LIMITED
香港星坤工業精密有限公司

△ X					ANGULAR	± 5°
△ X					L ≤ 4	± 0.2
△ X					4 < L ≤ 16	± 0.3
MARK	DESCRIPTION	DATE	REVISED	APPROVED	16 < L ≤ 63	± 0.4
					L > 63	± 0.5

DSND		DATE		SCALE: N/A	MODEL TYPE: X3025WV-XXXSN
DWN		DATE		VIEW:	PART NO.:
CHKD		DATE		UNIT: mm	3.00mm Crimp Style Connectors
APPD		DATE		SIZE: A4	DWG NO.:

REVISIONS
Authorized Signature(s)

UNSPECIFIED TOLERANCES

XKB INDUSTRIAL PRECISION CO., LIMITED

WEIGHT	SHEET	REVISION
1.0g	1/1	A0

1 2 3 4 5 6 7 8

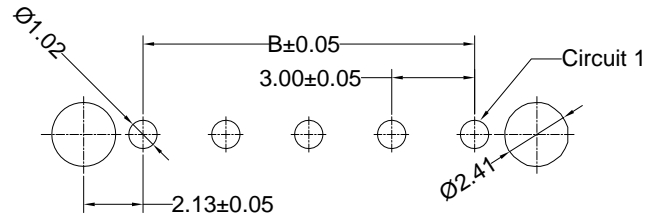
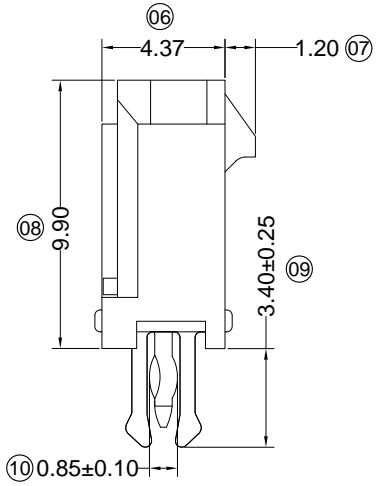
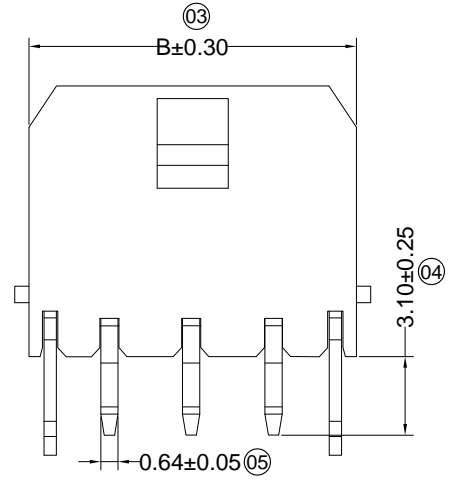
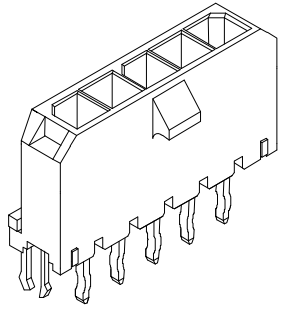
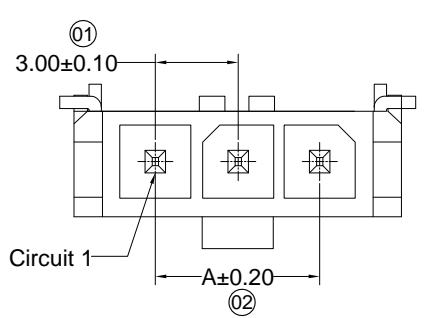

P.C.B LAYOUT

Specifications :

- Voltage rating: 250V AC / DC
- Current rating: 5A AC / DC
- Withstanding voltage: 1000V AC/minute
- Temperature range: -25°C~+85°C
- Insulation resistance: ≥1000MΩ
- Contact resistance: ≤10mΩ
- After environmental testing: ≤20mΩ

X3025W V X-XXC-XXSNXX

- ① Series No.
- ② Category: W-wafer
- ③ Welding Board Angle: V-180°
- ④ Welding Way: Blank-DIP
- ⑤ Row No.-Pin No. XX-Single row
- ⑥ Special NO. C-With a harpoon
- ⑦ Material: LP-LCP 94V-0 66-PA66 94V-0
- ⑧ Planting Category: V**:All Gold-Plated
G**:Gold-Plated Contact
*01-Gold Flash ; *02-2u" ; *03-3u" ; *05-5u"
*10-10u" ; *15-15u" ; *30-30u" ; *50-50u"
SN-Bright tin plating 70u"
SN1-Bright tin plating 120u"Min. ;
SW-Fog Tin plating
- ⑨ Color: Blank-natural color

Poles	Dimensions (mm)	
	A	B
2	3.00	9.65
3	6.00	12.65
4	9.00	15.65
5	12.00	18.65
6	15.00	21.65
7	18.00	24.65
8	21.00	27.65
9	24.00	30.65
10	27.00	33.65
11	30.00	36.65
12	33.00	39.65

X3025WV-XXC-66SN	PA66 UL 94V-0	Brass	Tin-Plated	X3025H
X3025WV-XXC-LPSN	LCP UL 94V-0			
PART NO	Material	Material(Pin)	Finish(Pin)	Mates With XKB Housing

For and on behalf of
XKB INDUSTRIAL PRECISION CO., LIMITED
 香港星坤工業精密有限公司

MARK	DESCRIPTION	DATE	REVISED	APPROVED	UNSPECIFIED TOLERANCES
△ X					ANGULAR ±5°
△ X					L ≤ 4 ±0.2
△ X					4 < L ≤ 16 ±0.3
					16 < L ≤ 63 ±0.4
					L > 63 ±0.5

DSND	DATE	SCALE: N/A	MODEL TYPE: X3025WV-XXC-XXSN
DWN	DATE	VIEW:	PART NO.:
CHKD	DATE	UNIT: mm	3.00 mm Crimp Style Connectors
APPD	DATE	SIZE: A4	DWG NO.:
XKB INDUSTRIAL PRECISION CO., LIMITED		WEIGHT 1.0g	SHEET 1/1
		REVISION A0	