



# 承认书

## APPROVAL SHEET

客户名称:

Customer

产品名称:

Part Name

产品规格:

Specification

版本号:

Version No.

日期:

DATE

功率电感器

Power Inductor

PRS6045 Series

17.01

2017-4-20

制造 Manufacturer			客户 Customer		
拟制 Draft by	审核 Checked by	确认 Approve by	检验 Check by	审核 Checked by	批准 Approval by
黎剑燕	冯东梅	徐建平			







序号 No	目 录 TABLE OF CONTENTS
1	结构及尺寸 Structure And Dimensions
2	型号规格表示办法 How To Order
3	电气性能 Performance Specification
4	可靠性 Reliability Data
5	包装 Package
6	环保情况说明 Environmental Protection Statement
7	推荐使用的焊接曲线 Recommended soldering profile
8	清洗 Cleaning
9	贮存方法 Storage Methods
10	使用注意事项 Precautions For Use



## 1. 结构及尺寸 Structure And Dimensions

单位 Unit: mm

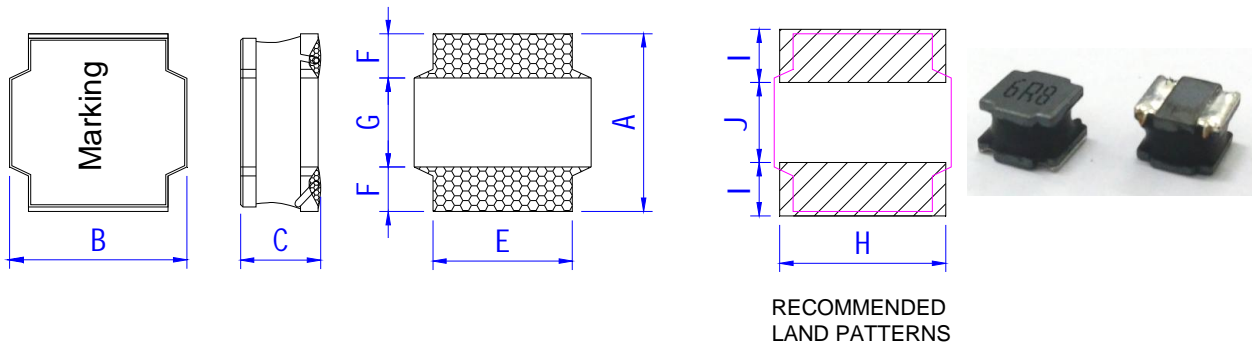

顶部印字 Marking: 1.0 $\mu$ H→1R0, 10 $\mu$ H→100, 100 $\mu$ H→101, 1000 $\mu$ H→102

A	B	C	E typical	F typical	G typical	H typical	I typical	J typical
6.0 $\pm$ 0.2	6.0 $\pm$ 0.2	4.5Max	5.0	1.5	3.0	5.7	1.9	2.6

结构图 Structural drawing:

No.	部位 Component	材料 Material
①	磁芯 Core	镍锌铁氧体磁芯 Ni-Zn ferrite core
②	线圈 Winding	漆包线 Enamelled Wire
③	保护层 Shield	导磁胶 magnetic glue
④	电极 Electrode	底层—银 Substrate—Ag 镀层—镍层 -- 锡层 Base plating—Ni-Sn 表层焊锡—锡 / 铜 Surface solder—Sn/Cu

## 2. 型号规格表示办法 How To Order

PRS    6045    -    1R0    □    T    □□□

①            ②            ③            ④            ⑤            ⑥

- ① 产品代号, Product symbol
- ② 尺寸规格, Dimension
- ③ 电感量标称值, Inductance
- ④ 电感量公差代码, Tolerance code, N  $\pm$ 30%, M  $\pm$ 20%, K  $\pm$ 10%
- ⑤ 包装代码, T-编带卷盘; B-散装, Packing code: T-Tape & reel; B-Bulk
- ⑥ 标准代码, 空缺-标准品, 标示-定制品,  
Standard code, Vacant-Standard product, Indicate-custom product



### 3. 电气性能 Performance Specification

客户料号 Customers Part No.	风华型号 Fenghua Part No.	电感量 Inductance(μH)		直流电阻 RDC (Ω) ±30%	饱和电流 Isat (A)	温升电流 I <sub>rms</sub> (A)	印字 Marking
		中心值 Normal	公差 Tolerance				
	PRS6045-R82□T	0.82	N ±30% M ±20%	0.008	10.35	5.90	R82
	PRS6045-1R0□T	1.0		0.014	8.50	5.14	1R0
	PRS6045-1R3□T	1.3		0.016	8.00	5.05	1R3
	PRS6045-1R8□T	1.8		0.018	7.00	4.95	1R8
	PRS6045-2R2□T	2.2		0.021	6.00	4.60	2R2
	PRS6045-3R0□T	3.0		0.024	5.00	3.80	3R0
	PRS6045-3R3□T	3.3		0.024	5.00	3.70	3R3
	PRS6045-4R5□T	4.5		0.031	4.00	3.30	4R5
	PRS6045-4R7□T	4.7		0.031	4.00	3.30	4R7
	PRS6045-6R3□T	6.3		0.035	3.80	3.15	6R3
	PRS6045-6R8□T	6.8		0.038	3.80	3.00	6R8
	PRS6045-8R2□T	8.2		0.043	3.50	2.70	8R2
	PRS6045-100□T	10		0.047	3.20	2.45	100
	PRS6045-150□T	15		0.077	2.50	2.05	150
	PRS6045-220□T	22		0.115	2.05	1.80	220
	PRS6045-330□T	33		0.145	1.65	1.45	330
	PRS6045-390□T	39		0.210	1.50	1.25	390
	PRS6045-470□T	47		0.220	1.40	1.20	470
	PRS6045-560□T	56		0.260	1.30	1.10	560
	PRS6045-680□T	68		0.330	1.20	1.00	680
	PRS6045-820□T	82	0.450	1.05	0.90	820	
	PRS6045-101□T	100	0.500	0.95	0.80	101	
	PRS6045-151□T	150	0.800	0.80	0.70	151	
	PRS6045-181□T	180	0.950	0.75	0.65	181	
	PRS6045-221□T	220	1.200	0.70	0.59	221	
	PRS6045-331□T	330	1.700	0.57	0.57	331	
	PRS6045-102□T	1000	4.500	0.30	0.20	102	

测试仪器 Test equipment: Inductance\RDC---HP4263B or equivalent, Isat\I<sub>rms</sub>--- Microtest 6379 & 6220 or equivalent.

Ls 测试频率/电压 Ls Test frequency/Voltage: 100kHz/500mV;

Isat: 指使电感量比初始值下降约 30%的电流值,

I<sub>rms</sub>: 指使电感器表面温度上升 40℃的电流值 (参考周围环境温度 20℃)。

Isat: DC current at which the inductance drops approximate 30% from its value without current;

I<sub>rms</sub>: The DC current is inductor surface temperature to rise by 40℃ ( Reference ambient temperature 20℃).



## I 特性曲线图 Characteristic Curve

$L_s$  Vs DC BIAS (Typical)

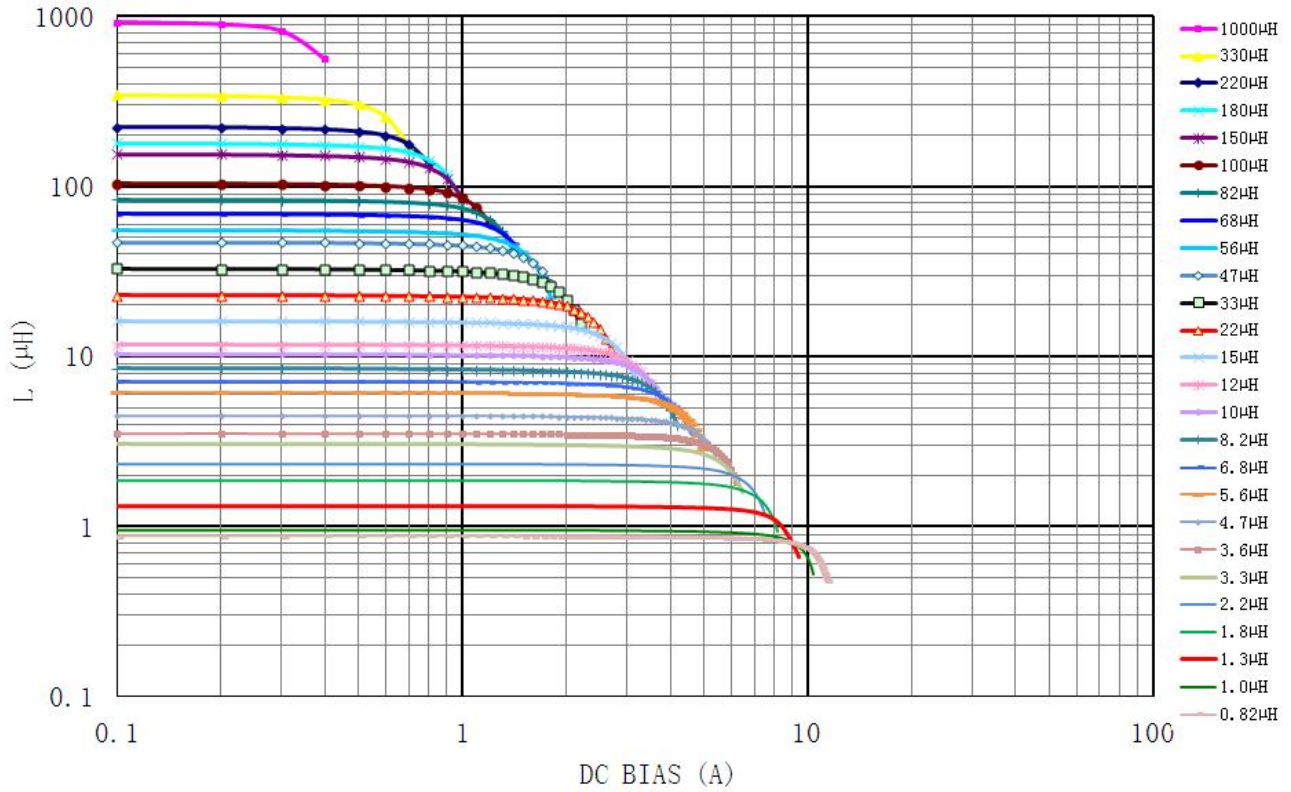



#### 4. 可靠性 Reliability Data

序号 No.	项目 Items	要求 Requirements	试验方法及备注 Test Methods and Remarks
1	工作温度范围 Operating Temperature Range	-40℃ ~ +125℃	包括自身发热的上升温度 Including self-heating temperature rise.
2	绝缘电阻 Insulation Resistance	≥100MΩ	在电感器线圈和磁芯之间施加 (100±15) V 直流电压保持(60±2) s。 (100±15) V DC between inductor coil and core for (60±2) seconds.
3	可焊性 Solderability	电极面 90%以上覆盖新的焊料。 90% or more of electrode area shall be coated by new solder.	在 (245±5) °C 熔融的焊锡 (96.5Sn/3.0Ag/0.5Cu) 中浸(5±1) s。 Dip pads in flux and dip in solder pot (96.5Sn/3.0Ag/0.5Cu) at (245±5) °C for (5±1) seconds.
4	耐焊接热 Resistance to Soldering Heat	外观无可见机械损伤; 电感量变化率: ±10%以内。 No visible mechanical damage. Inductance change: Within ±10%	在 (260±5) °C 熔融的焊锡 (96.5Sn/3.0Ag/0.5Cu) 中浸(10±1) s。 Dip pads in flux and dip in solder pot (96.5Sn/3.0Ag/0.5Cu) at (260±5) °C for (10±1) seconds.
5	端子强度 Adhesion of terminal electrode	元件的端子与本体结合无松动、无脱落。 Strong bond between the pad and the core, without come off PC board.	将电感器用(260±5) °C, (20±5) s 焊在带有 0.3 mm 厚锡膏的基板上, 然后用治具垂直电极面方向加压 10 N, (10±1) s。 Inductors shall be subjected to (260±5) °C for (20±5) s Soldering in the base whit 0.3mm solder. And then aplomb electrode way plus tax 10 N for (10±1) seconds.
6	温度特性 Temperature characteristic	电感量变化率 $P_{c-b}, P_{c-d}$ 不超过 ±20%。 Inductance change $P_{c-b}, P_{c-d}$ Within ±20%	a: +20 °C (30~45) min → b: -40 °C (30~45) min → c: +20 °C (30~45) min → d: +85 °C (30~45) min → e: +20 °C (30~45) min $P_{c-b} = \frac{L_b - L_c}{L_c} \times 100\%$ ; $P_{c-d} = \frac{L_d - L_c}{L_c} \times 100\%$
7	恒定湿热 Static Humidity	外观无可见机械损伤; 电感量变化率: ±10%以内。 No visible mechanical damage. Inductance change: Within ±10%	将电感器放置在于湿度(93±3)%RH, 温度(40±2) °C 的环境中存放(96±2) h, 在室温下放置 2 小时后、48 小时内测试。 Inductors shall be subjected to (93±3)%RH . at (40±2) °C for (96±2) h . Placed at room temperature for 2 hours, within 48 hours of testing.





(续上表 Continue on the table)

序号 No.	项目 Items	要求 Requirements	试验方法及备注 Test Methods and Remarks
8	气候顺序 Climate order	外观无可见机械损伤; 电感量变化率: $\pm 10\%$ 以内。 No visible mechanical damage. Inductance change: Within $\pm 10\%$	1.高温: GB/T 2423.2-2008 试验方法 Bb, 温度 $(+125 \pm 2)^\circ\text{C}$ ,时间 $(96 \pm 2)\text{h}$ ; 2.交变湿热-第一个循环: GB/T 2423.4-2008 试验方法Db: 温度 $+25^\circ\text{C} \rightarrow +55^\circ\text{C}$ ,循环1次, 按24小时循环; 3.低温: GB/T 2423.1-2008, 低温试验方法Ab, $(-40^\circ\text{C} \pm 2)^\circ\text{C}$ , 时间 $(96 \pm 2)\text{h}$ ; 4.交变湿热 -其余的循环 GB/T 2423.4-2008 试验方法Db: 温度 $+25^\circ\text{C} \rightarrow +55^\circ\text{C}$ ,循环1次, 按24小时循环; 在室温下放置2小时后、48小时内测试。 1. High temperature: According to GB / T 2423.2-2008 Standard Test Method Bb, temperature is $(+125 \pm 2)^\circ\text{C}$ and keep $(96 \pm 2)$ hours. 2. Alternating hot and humid (The first cycle): According to GB / T 2423.4-2008 Standard Test Method Db, the temperature cycle shall be placed at $+25^\circ\text{C}$ and $+55^\circ\text{C}$ for 24h. 3. Low temperature: According to GB / T 2423.1-2008 Standard Test Method Ab, temperature is $(-40 \pm 2)^\circ\text{C}$ and keep $(96 \pm 2)$ hours. 4. Alternating hot and humid (Other cycles): According to GB / T 2423.4-2008 Standard Test Method Db, the temperature cycle shall be placed at $+25^\circ\text{C}$ and $+55^\circ\text{C}$ for 24h. Placed at room temperature for 2 hours, within 48 hours of testing.
9	温度变化 Thermal shock	外观无可见机械损伤; 电感量变化率: $\pm 10\%$ 以内。 No visible mechanical damage. Inductance change: Within $\pm 10\%$	$(-40 \pm 3)^\circ\text{C}$ ,时间 $(30 \pm 3)\text{min} \leftrightarrow (85^\circ\text{C} \pm 2)^\circ\text{C} / (30 \pm 3)\text{min}$ , 转换时间 $(2 \sim 3)\text{min}$ ,循环5次; 在室温下放置2小时后、48小时内测试。 The test sample shall be placed at $(-40 \pm 3)^\circ\text{C}$ and $(85 \pm 2)^\circ\text{C}$ for $(30 \pm 3)\text{min}$ , different temperature conversion time is 2-3 minutes. The temperature cycle shall be repeated 5 cycles. Placed at room temperature for 2 hours, within 48 hours of testing.
10	耐久性 (寿命) Life	外观无可见机械损伤; 电感量变化率: $\pm 10\%$ 以内。 No visible mechanical damage. Inductance change: Within $\pm 10\%$	温度 $(85 \pm 2)^\circ\text{C}$ , 时间 $(1000 \pm 24)\text{h}$ ,施加额定电流, 在室温下放置2小时后、48小时内测试。 Inductors shall be store at $(85 \pm 2)^\circ\text{C}$ for $(1000 \pm 24)$ hours with rated current applied. Placed at room temperature for 2 hours, within 48 hours of testing.





## 5. 包装 Package

### 5.1 载带尺寸 Tape Dimension(单位: 毫米 Unit:mm)

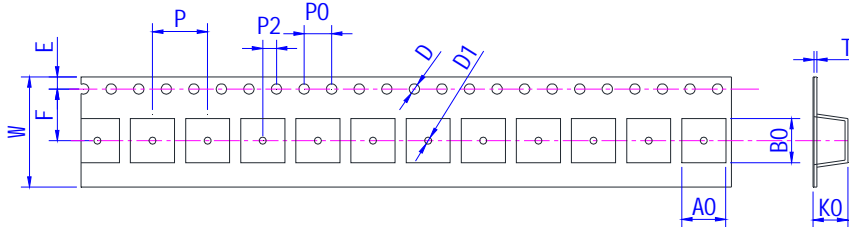

W	A0	B0	D	D1	E	F	K0	P0	P2	P	T
16±0.5	6.4±0.3	6.4±0.3	1.5±0.3	1.5MIN	1.75±0.3	7.5±0.3	4.7±0.3	4.0±0.3	2.0±0.3	8.0±0.3	0.40±0.10

### 5.2 供料方向 Direction of feed(单位: 毫米 Unit:mm)

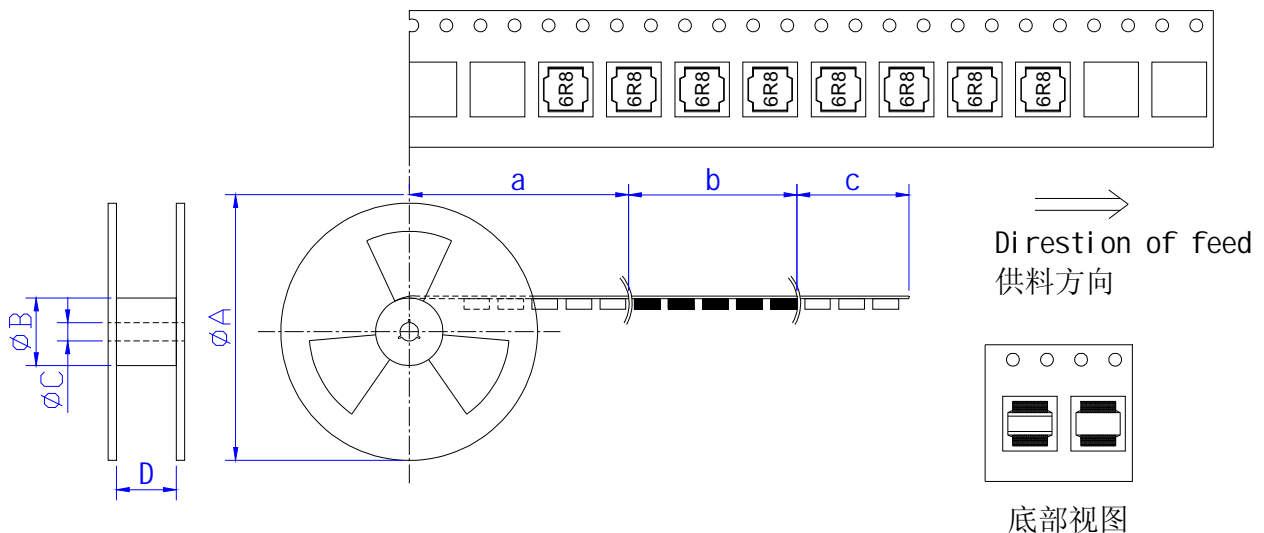

A	B	C	D	a	b	c
330 typ.	100 typ.	13 typ.	16.4 typ.	空带 blank portions	装元件 chip cavity	引带 leader

### 5.3 包装数量 Packing quantity

卷盘 REEL (PCS)	纸盒 BOX (PCS)	中号纸箱 Medium Carton (PCS) (Size: 35.8*35.8*20cm)	大号纸箱 Large Carton (PCS) (Size: 35.8*35.8*29.5cm)
1,500	6,000	----	18,000

### 5.4 剥离力要求 Peeling required

5.4.1 F 力大小 F force: 20 ~ 100g;

5.4.2 面带剥离速度 Peeling speed: 300mm/min±10%;

5.4.3 面带剥离角度 Peeling angle: 165° ~ 180°.

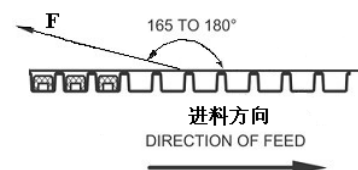



## 6. 环保情况说明 Environmental Protection Statement

**RoHS 指令:** 公司产品符合 RoHS 指令。

Response to RoHS directive: Our products are RoHS compliance.

## 7. 推荐使用的焊接曲线 Recommended soldering profile

本产品建议使用回流焊接法。

Applicable soldering process to the products is reflow soldering.

### 7.1 焊接材料 Soldering Materials

7.1.1 焊料 Solder: Sn-3.0Ag-0.5Cu

7.1.2 助焊剂: 使用松香基助焊剂, 禁止使用卤化物含量超过 0.2wt% 的强酸性助焊剂和水溶性助焊剂。

Flux: Use rosin-based flux, but not strongly acidic flux (with chlorine exceeding 0.2 wt%). Do not use water-soluble flux.

### 7.2 焊接曲线 Soldering Profile

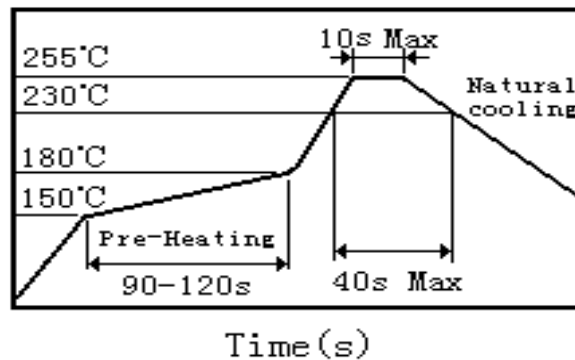

### 7.3 烙铁焊接 Soldering Iron

使用烙铁进行返修时要求在 150°C 下预热至少 1 分钟, 不能直接用焊头接触磁体, 返修焊接条件如下:  
Reworking with electric soldering iron must preheating at 150°C for 1 minute is required, and do not directly touch the core with the tip of the soldering iron. The reworking soldering conditions are as follows:

7.3.1 烙铁头温度 Temperature of soldering iron tip: 350°C;

7.3.2 烙铁输出功率 Soldering iron power output: ≤30W;

7.3.3 烙铁头直径 Diameter of soldering iron end: ≤1.0mm;

7.3.4 焊接时间 Soldering time: <3 s

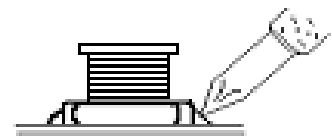



## 8. 清洗 Cleaning

对本产品进行清洗操作前，需确认以下条件：

The following conditions should be observed when cleaning the products:

8.1 清洗温度：≤60℃（酒精清洗剂≤40℃）

Cleaning Temperature: 60℃ max. (40℃ max. for alcohol cleaning agents)

8.2 超声波清洗，Ultrasonic:

输出 Output: 20 W/L max.

持续时间 Duration: 5 min max.

频率 Frequency: 28 to 40kHz

8.3 清洗时要避免 PCB 板和安装产品的共振。Avoid the resonance between PCB and mounted products when it is cleaning.

## 9. 贮存方法 Storage Methods

9.1 存储期限 Storage Period

为保证端子电极的焊接特性和包装材料处于良好状态，请于本公司发货后 6 个月内使用本产品。同时，由于端子电极的焊接特性会随时间发生变化，如果贮存时间超过 6 个月，请首先确认其焊接特性后再安装使用。

To maintain the solderability of terminal electrodes and to keep the packing material in good condition, product should be used within 6 months from the time of delivery. And the solderability of products electrodes may decrease as time passes, so in case of storage over 6 months, solderability shall be checked before actual usage.

9.2 存储条件 Storage Conditions

9.2.1 存放货物的仓库应满足以下条件：Store products in a warehouse in compliance with the following condition:

温度(Temperature): -10 ~ +40℃

相对湿度(Humidity): 30~70%RH

9.2.2 不要使产品遭受温度和湿度的快速变化。Do not subject products to rapid changes in temperature and humidity.

9.2.3 不要将产品存放在化学环境中，如硫酸气体或碱性气体中，否则会降低电极端子的焊接特性和使电感器腐蚀。Do not store the products in chemical atmosphere such as one containing sulfurous acid gas or alkaline gas, that will causes poor solderability and corrosion of inductors.

9.2.4 不要以散包装的形式存放产品以防止电感器间的相互碰撞造成磁芯破裂或断线。Do not store products in bulk packaging to prevent collision among inductors which causes core chipping and wire breakage.

9.2.5 为了避免受潮气、灰尘等物质的影响，产品应保管于货架上。Store products on pallets to protect from humidity, dust, etc.

9.2.6 产品应避免热冲击、振动以及直接光照等等。Avoid heat shock, vibration, direct sunlight, etc.



## 10. 使用注意事项 Precautions For Use

- 10.1 本公司产品适用于 AV 设备、OA 设备、家电、信息服务等一般电子设备中。Our products are designed and promoted for use in general electronic devices such as audio-equipment, office automation equipment, household appliance and information service.
- 10.2 当本公司的产品使用在一般电子设备以外的领域时，对于此所引发的设备失效我司将不承担任何法律责任。In case of using the product for the purpose other than general electronics devices, we shall not be held liable for any dysfunctions in or damage to the equipment with which the product is used.
- 10.3 本承认书只保证我司产品作为一个单体时的质量情况，当我司产品被安装到贵司产品上时，请贵司对使用在贵司电路上的产品情况进行了有效评价和确认。Our specification limits the quality of the component as a single unit. Please ensure the component is thoroughly evaluated in your application circuit.
- 10.4 不要对产品施加过大的振动或机械冲击；Do not apply excessive vibration or mechanical shock to products.
- 10.5 为防止断线，请不要使用锋利的物体接触线圈，如镊子；Do not touch wire with sharp objects such as tweezers to prevent wire breakage.
- 10.6 在产品贴装时不要使用过大的压力，避免磁芯断裂。Do not apply excessive stress to products mounted on boards to prevent core breakage.