

Product Overview

The TQP7M9105 is a high linearity, high gain 1 W driver amplifier in industry standard, RoHS compliant, SOT-89 surface mount package. This InGaP/GaAs HBT delivers high performance across 0.05 to 1.5 GHz while achieving +47 dBm OIP3 and +30 dBm P1dB at 940 MHz while only consuming 220 mA quiescent current. All devices are 100% RF and DC tested.

The TQP7M9105 incorporates on-chip features that differentiate it from other products in the market. The amplifier has a dynamic active bias circuit that enable stable operation over bias and temperature variations and can provide a high linearity at back-off operation

The TQP7M9105 is targeted for use as a driver amplifier in wireless infrastructure where high linearity, medium power, and high efficiency are required. The device an excellent candidate for transceiver line cards and high power amplifiers in current and next generation multi-carrier 3G/4G base stations.



3-pin SOT-89 Package

Key Features

- 50 – 1500 MHz
- +30 dBm P1dB at 940 MHz
- +47 dBm Output IP3 at 940 MHz
- 19.5 dB Gain at 940 MHz
- +5 V Single Supply, 220 mA Current
- Internal RF Overdrive Protection
- Internal DC Overvoltage Protection
- On Chip ESD Protection
- SOT-89 Package

Functional Block Diagram

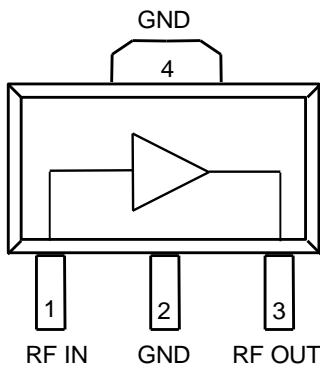

Top View

Applications

- Repeaters
- BTS Transceivers
- BTS High Power Amplifiers
- CDMA / WCDMA / LTE
- General Purpose Wireless
- ISM Equipment

Ordering Information

Part No.	Description
TQP7M9105	1 W High Linearity Amplifier
TQP7M9105-PCB900	920–960 MHz Evaluation Board

Standard T/R size = 1000 pieces on a 7" reel

Absolute Maximum Ratings

Parameter	Rating
Storage Temperature	-65 to 150 °C
RF Input Power, CW, 50 Ω, T=+25 °C	+30 dBm
Device Voltage (V _{CC})	+8 V

Operation of this device outside the parameter ranges given above may cause permanent damage.

Recommended Operating Conditions

Parameter	Min	Typ	Max	Units
Device Voltage (V _{CC})		+5.0	+5.25	V
T _{CASE}	-40		+105	°C
T _j for >10 ⁶ hours MTTF			+170	°C

Electrical specifications are measured at specified test conditions. Specifications are not guaranteed over all recommended operating conditions.

Electrical Specifications

Test conditions unless otherwise noted: V_{CC} = +5.0 V, Temp= +25 °C

Parameter	Conditions	Min	Typ	Max	Units
Operational Frequency Range		50		1500	MHz
Test Frequency			940		MHz
Gain		17.5	19.4	20.5	dB
Input Return Loss			14		dB
Output Return Loss			15		dB
Output P1dB		+28.7	+30		dBm
Output IP3	P _{out} = +15 dBm/tone, Δf = 1 MHz	+43.5	+47		dBm
WCDMA Output Power	-50 dBc ACLR ⁽¹⁾		+20.5		dBm
Noise Figure			6.3		dB
Quiescent Current, I _{CO}		195	220	245	mA
Thermal Resistance, θ _{jc}	Module (junction to case)		27.3		°C/W

Notes:

ACLR Test set-up: 3GPP WCDMA, TM1+64 DPCH, +5 MHz offset, PAR = 10.2 dB at 0.01% Prob.

Device Characterization Data

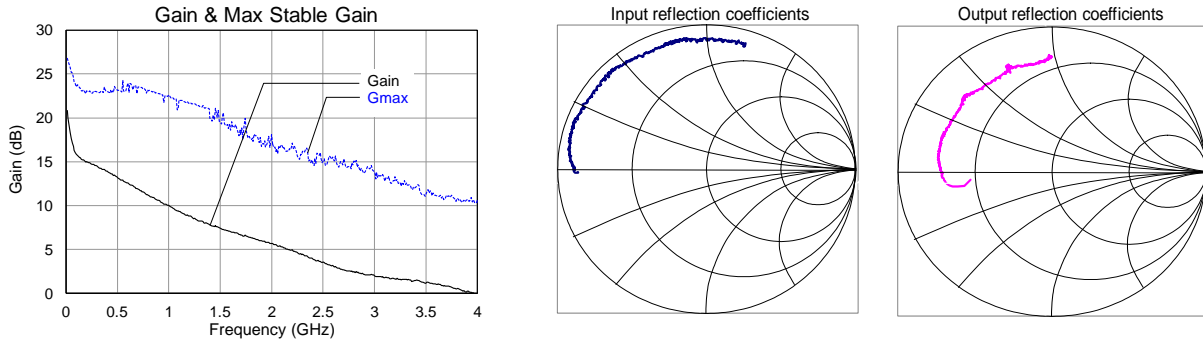

Note: The gain for the unmatched device in 50 ohm system is shown as the trace in black color, [gain (S(21))]. For a tuned circuit for a particular frequency, it is expected that actual gain will be higher, up to the maximum gain. The maximum stable gain is shown as the blue trace [Gmax]. The impedance plots are shown from 0.01– 4 GHz.

S-Parameters

Test Conditions: $V_{CC}=+5\text{ V}$, $I_{CQ}=220\text{ mA}$, $T=+25^{\circ}\text{C}$, unmatched 50 ohm system, calibrated to device leads

Freq (GHz)	S11 (dB)	S11 (ang)	S21 (dB)	S21 (ang)	S12 (dB)	S12 (ang)	S22 (dB)	S22 (ang)
0.05	-1.06	-178.68	17.88	154.59	-36.95	1.89	-3.39	-171.92
0.1	-1.08	-179.98	16.04	154.96	-37.20	3.77	-3.00	-176.29
0.2	-1.01	179.18	15.20	150.91	-37.52	7.85	-2.91	-179.66
0.4	-0.75	176.01	14.04	134.55	-36.48	11.27	-2.73	176.91
0.6	-0.57	171.34	12.73	120.33	-35.65	11.92	-2.52	173.48
0.8	-0.51	166.55	11.29	108.35	-35.14	9.35	-2.51	169.15
1.0	-0.51	163.55	10.11	98.59	-34.89	11.74	-2.50	165.78
1.2	-0.54	161.26	8.87	90.63	-34.56	11.00	-2.52	163.07
1.4	-0.57	157.96	7.85	82.50	-34.07	10.99	-2.61	160.70
1.6	-0.62	154.88	7.10	75.78	-33.47	10.29	-2.57	158.17
1.8	-0.66	150.04	6.35	67.47	-33.19	11.13	-2.66	155.39
2.0	-0.60	144.26	5.75	59.82	-32.84	4.95	-2.64	151.03
2.2	-0.56	139.27	4.95	51.93	-32.47	3.98	-2.59	146.61
2.4	-0.75	135.92	3.91	45.80	-32.62	1.55	-2.57	141.55
2.6	-0.58	132.79	3.16	40.57	-32.36	2.07	-2.28	139.39
2.8	-0.55	132.30	2.52	36.55	-32.25	2.62	-2.33	138.20
3.0	-0.64	129.89	2.01	31.75	-31.94	0.51	-2.37	136.78
3.2	-0.69	126.19	1.69	26.65	-31.44	1.40	-2.40	135.83
3.4	-0.84	121.41	1.48	20.86	-30.84	-2.57	-2.54	133.06
3.6	-0.93	115.44	1.06	12.97	-30.84	-4.71	-2.68	126.60
3.8	-0.85	110.18	0.51	5.81	-30.20	-10.30	-2.63	119.65
4.0	-0.80	106.76	-0.04	-0.51	-30.40	-11.85	-2.51	114.02

Evaluation Board 615 – 655 MHz Reference Design

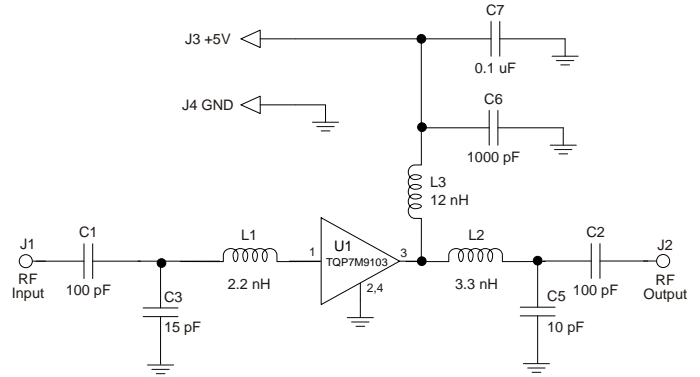
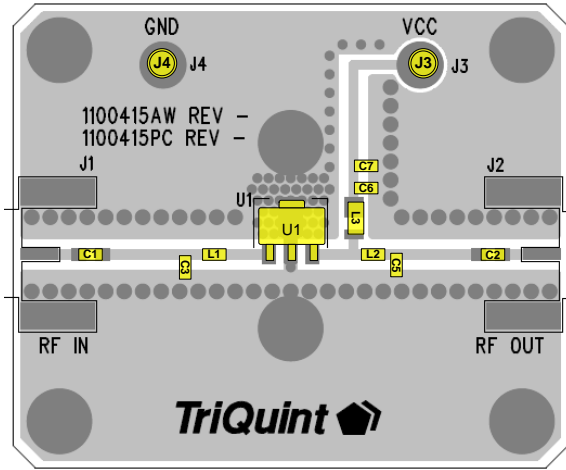

Notes:

1. Components shown on the silkscreen but not on the schematic are not used.
2. 0 Ω resistor can be replaced with copper trace in the target application layout.
3. All components are of 0603 size unless stated on the schematic.
4. The recommended component values are dependent upon the frequency of operation.
5. Critical component placement locations:
 - Distance between U1 Pin 1 Pad left edge to L1 (right edge): 100 mil
 - Distance between U1 Pin 1 Pad left edge to C3 (right edge): 200 mil
 - Distance between U1 Pin 3 Pad right edge to C5 (left edge): 210 mil
 - Distance between U1 Pin 3 Pad right edge to L2 (left edge): 120 mil

Bill of Material 615 – 655 MHz

Reference Des.	Value	Description	Manuf.	Part Number
n/a	n/a	Printed Circuit Board	Qorvo	
U1	n/a	1 W High Linearity Amplifier	Qorvo	TQP7M9105
C3	15 pF	CAP, 0603, ± 0.05 pF, 50V, NPO	AVX	06032U150J
C5	10 pF	CAP, 0603, ± 0.05 pF, 50V, NPO	AVX	06032U100J
C1, C2	100 pF	CAP, 0603, 5%, 50V, NPO/COG	various	
C6	1000 pF	CAP, chip	various	
C7	0.1 uF	CAP, 0603, 10%, X5R, 10V	various	
L1	2.2 nH	IND, 0603, +/-0.3nH	TOKO	LL1608-FSL2N2S
L2	3.3 nH	IND, 0603, +/-0.3nH	TOKO	LL1608-FSL3N3S
L3	12 nH	IND, 0805, 5%, Wirewound	Coilcraft	0805CS-120XJL

Typical Performance 615 – 655 MHz

Test conditions unless otherwise noted: $V_{CC} = +5\text{ V}$, $I_{CQ} = 235\text{ mA}$, $Temp. = +25\text{ }^{\circ}\text{C}$

Parameter	Conditions	Typical Value			Units
Frequency		617	635	652	MHz
Gain		21.6	21.6	21.6	dB
Input Return Loss		10.5	11	11	dB
Output Return Loss		17	16.5	17.5	dB
Output P1dB		+30.3	+30.5	+30.8	dBm
OIP3	$P_{out} = +16\text{ dBm / tone, } \Delta f = 1\text{ MHz}$	+44.7	+43.8	+42.7	dBm
WCDMA Channel Power ⁽¹⁾	ACLR = -50 dBc	+18	+17.5	+16.8	dBm

Notes:

- 1C 20MHz LTE signal, PAR=9.5dB

Performance Plots 615 – 655 MHz

Test conditions unless otherwise noted: $V_{CC} = +5\text{ V}$, $I_{CQ} = 235\text{ mA}$, $Temp. = +25\text{ }^{\circ}\text{C}$

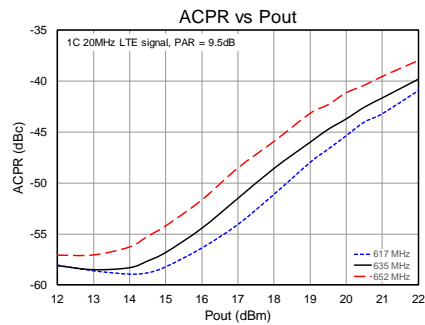
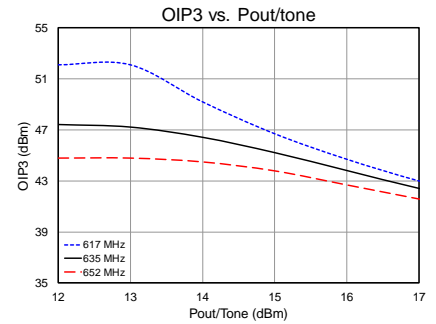
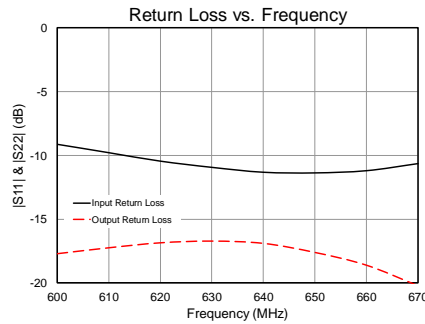
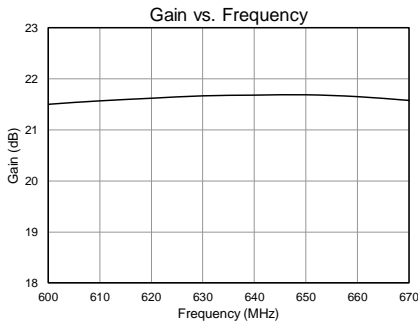

Evaluation Board – TQP7M9105-PCB900 (860 – 960 MHz)

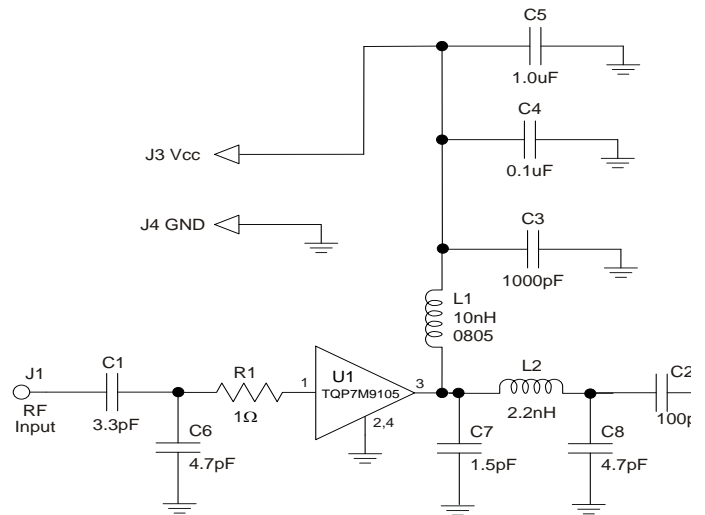
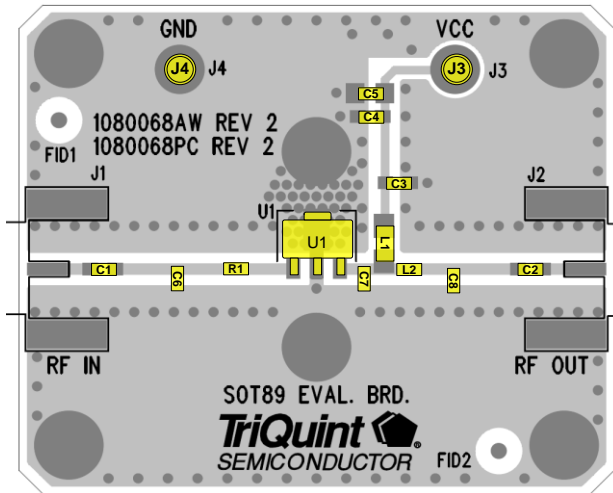

Notes:

- See Evaluation Board PCB Information section for PCB material and stack-up.
- Components shown on the silkscreen but not on the schematic are not used.
- The recommended component values are dependent upon the frequency of operation.
- All components are of 0603 size unless stated on the schematic.
- Critical component placement locations:
 Distance from U1 Pin 1 Pad (left edge) to R1 (right edge): 100 Mils (4.85° at 940 MHz)
 Distance from U1 Pin 1 Pad (left edge) to C6 (right edge): 270 Mils (13.1° at 940 MHz)
 Distance from U1 Pin 3 Pad (right edge) to C7 (left edge): 40 Mils (1.94° at 940 MHz)
 Distance from U1 Pin 3 Pad (right edge) to L2 (left edge): 120 Mils (5.82° at 940 MHz)
 • Distance from U1 Pin 3 Pad (right edge) to C8 (left edge): 260 Mils (12.6° at 940 MHz)

Bill of Material TQP7M9105-PCB900

Reference Des.	Value	Description	Manuf.	Part Number
n/a	n/a	Printed Circuit Board	Qorvo	
U1	n/a	TQP7M9105 Amplifier, SOT-89 pkg.	Qorvo	
C1	3.3 pF	Cap., Chip, 0603, ±0.1 pF, 50 V, Accu-P	AVX	06035J3R3ABSTR
C2	100 pF	Cap., Chip, 0603, 5%, 50 V, NPO/COG	various	
C3	1000 pF	Cap., Chip, 0603, 5%, 50 V, NPO/COG	various	
C4	0.1 μF	Cap., Chip, 0603, 10%, 16 V, X7R	various	
C5	1.0 μF	Cap., Chip, 0603, 10%, 10 V, X5R	various	
C7	1.5 pF	Cap., Chip, 0603, ±0.05 pF, 50 V, Accu-P	AVX	06035J1R5ABSTR
C6, C8	4.7 pF	Cap., Chip, 0603, ±0.05 pF, 50 V, Accu-P	AVX	06035J4R7ABSTR
L1	10 nH	Inductor, 0805, 5%, Coilcraft CS Series	Coilcraft	0805CS-100XJLB
L2	2.2 nH	Inductor, 0603, ±0.3 nH	Toko	LL1608-FSL2N2S
R1	1 Ω	Resistor, Chip, 0603, 5%, 1/16 W	various	

Typical Performance 860 – 960 MHz (TQP7M9105-PCB900)

Test conditions unless otherwise noted: $V_{CC} = +5\text{ V}$, $I_{CQ} = 220\text{ mA}$, Temp. = $+25\text{ }^\circ\text{C}$

Parameter	Typical Value						Units
Frequency	860	880	900	920	940	960	MHz
Gain	18.9	19.2	19.3	19.4	19.4	19.3	dB
Input Return Loss	7.9	9.5	11.3	13	14	13	dB
Output Return Loss	16.2	16.7	16.8	15	15	14	dB
Output P1dB	+29	+29.2	+29.5	+29.9	+30.0	+29.8	dBm
Output IP3 ⁽¹⁾	+48	+50.2	+50.6	+49.5	+49.2	+49	dBm
WCDMA Channel Power ^(2,3)	20	20.2	20.5	+20.5	+20.5	+20.5	dBm
Noise figure	6.8	6.6	6.4	6.4	6.4	6.3	dB

Notes:

- +15 dBm/tone, $\Delta f = 1\text{ MHz}$
- At -50 dBc ACLR
- 3GPP WCDMA, TM1+64 DPCH, +5 MHz offset, PAR = 10.2 dB at 0.01% Prob.

RF Performance Plots 860 – 960 MHz (TQP7M9105-PCB900)

Test conditions unless otherwise noted: $V_{CC} = +5\text{ V}$, $I_{CQ} = 235\text{ mA}$, Temp. = $+25\text{ }^\circ\text{C}$

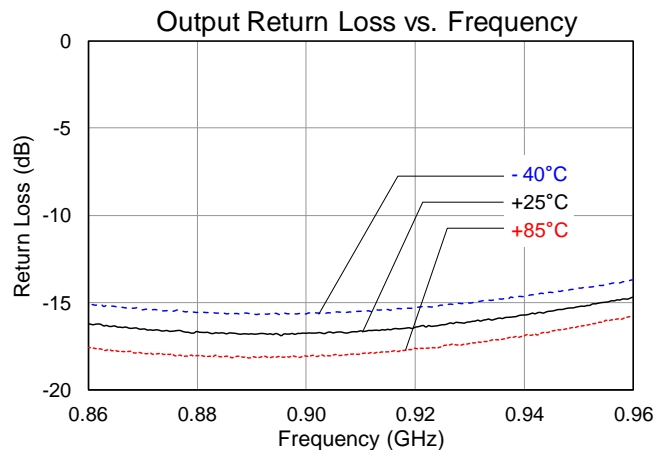
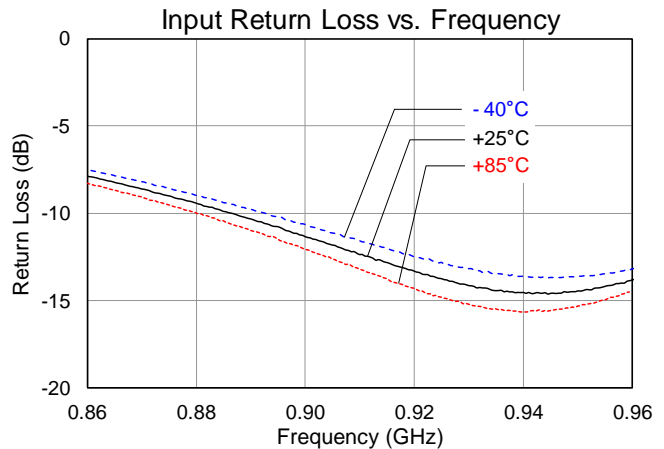
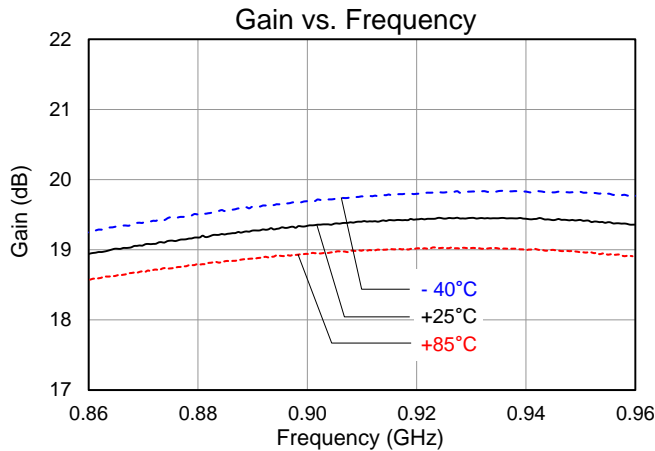

Performance Plots 860 – 960 MHz (TQP7M9105-PCB900)

Test conditions unless otherwise noted: $V_{CC} = +5\text{ V}$, $I_{CQ} = 235\text{ mA}$, $Temp. = +25\text{ }^{\circ}\text{C}$

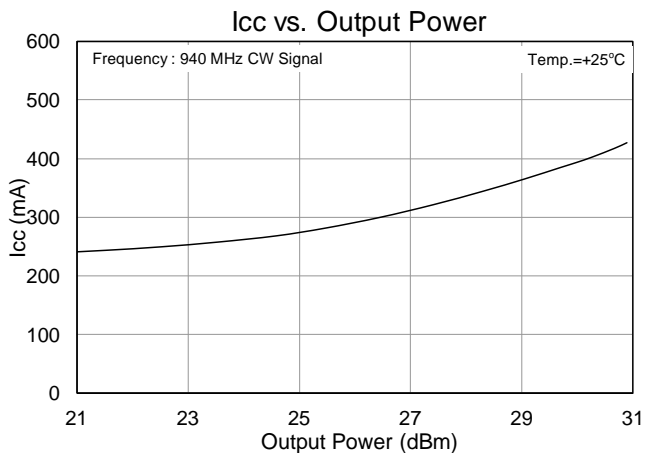
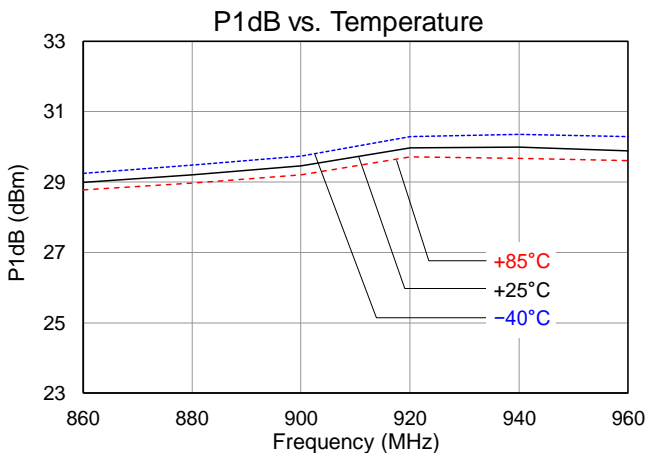
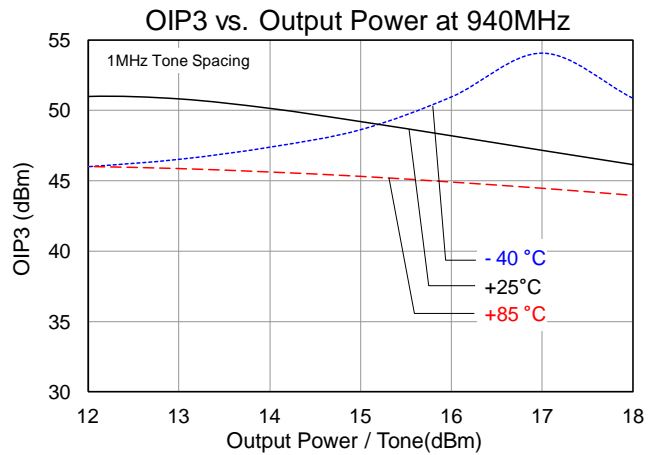
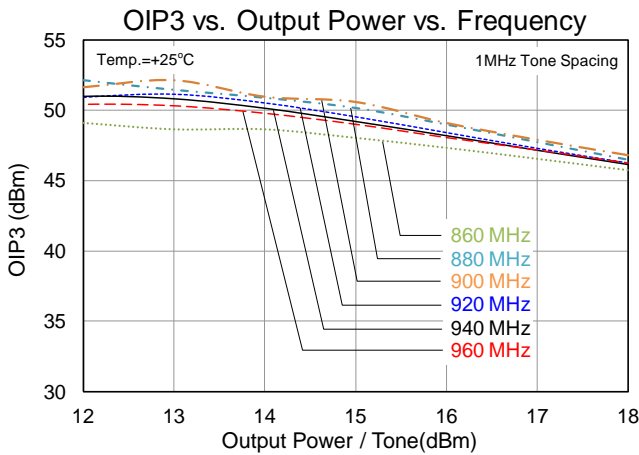
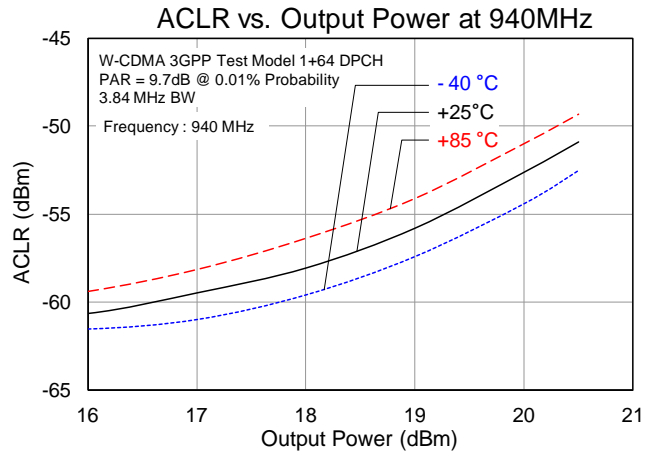
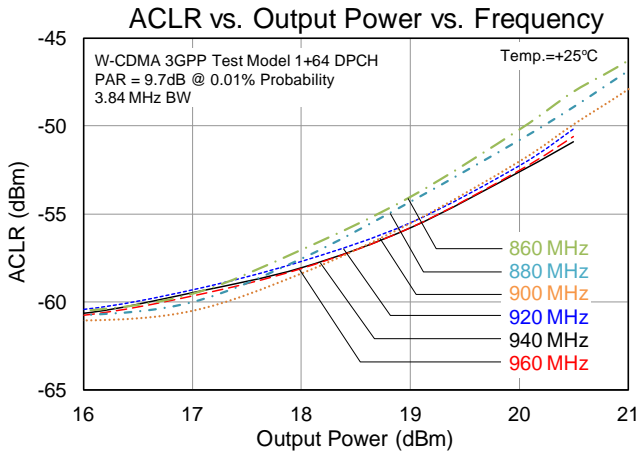

Evaluation Board 700 – 1000 MHz Reference Design

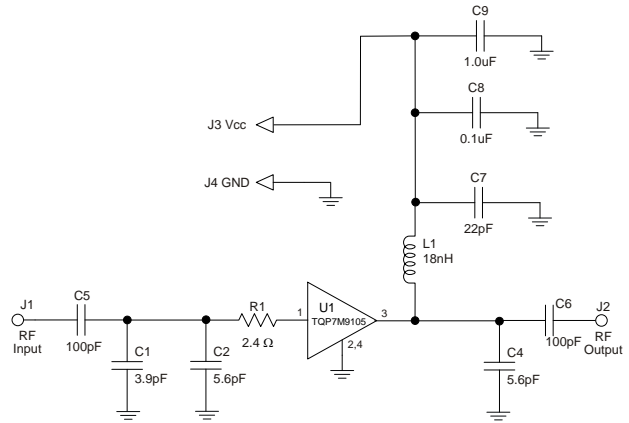
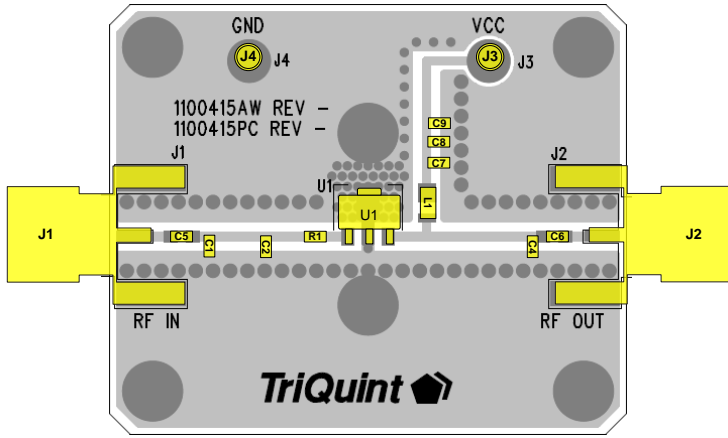

Notes:

6. Components shown on the silkscreen but not on the schematic are not used.
7. All components are of 0603 size unless stated on the schematic.
8. The recommended component values are dependent upon the frequency of operation.
9. Critical component placement locations:
 - Distance between U1 Pin 1 Pad to R1 (right edge): 45 mil
 - Distance between U1 Pin 1 Pad to C1 (right edge): 370 mil
 - Distance between U1 Pin 1 Pad to C2 (right edge): 195 mil
 - Distance between U1 Pin 3 Pad to C4 (left edge): 395 mil

Bill of Material 700 – 1000 MHz

Reference Des.	Value	Description	Manuf.	Part Number
n/a	n/a	Printed Circuit Board	Qorvo	1100415
U1	n/a	1 W High Linearity Amplifier	Qorvo	TQP7M9105
C1	3.9 pF	CAP, 0603, ± 0.1 pF, 100V, NPO/COG	AVX	06035J3R9ABSTR
C2, C4	5.6 pF	CAP, 0603, ± 0.1 pF, 100V, NPO/COG	AVX	06035J5R6ABSTR
C5, C6	100 pF	CAP, 0603, 5%, 50V, NPO/COG	various	
C7	22 pF	CAP, 0603, 5%, 50V, NPO/COG	Various	
C8	0.1 uF	CAP, 0603, 5%, 50V, NPO/COG	various	
C9	1.0 uF	CAP, 0603, 10%, X5R , 10V	various	
R1	2.4 Ω	RES, 0603, 5%, 1/16W, Chip	various	
L1	18 nH	IND, 0805, 5%, Ceramic	Coilcraft	0805CS-180XJL

Typical Performance 700 – 1000 MHz

Test Conditions: $V_{CC}=+5\text{ V}$, $Temp.=+25^{\circ}\text{C}$, 50Ω System

Parameter	Conditions	Typical Value				Units
		700	800	900	1000	
Frequency		700	800	900	1000	MHz
Gain		17.2	17.9	18	16.9	dB
Input Return Loss		7.7	13.3	15.3	7.8	dB
Output Return Loss		8.5	10.9	14	15.7	dB
Output P1dB		+28.5	+29.5	+30.5	+30.5	dBm
Output IP3	Pout= +15 dBm/tone, $\Delta f= 1\text{ MHz}$	+45	+47	+44	+42.6	dBm
Quiescent Collector Current, I_{CQ}		225				mA

Performance Plots 700 – 1000 MHz

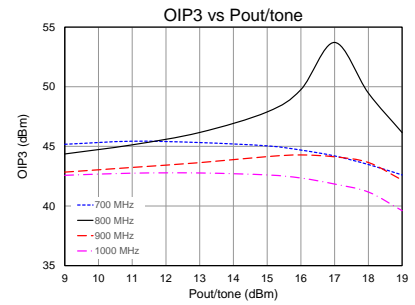
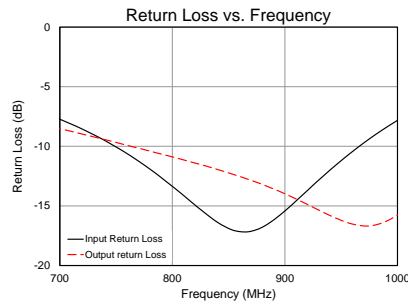
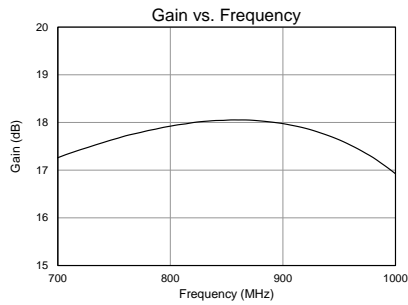

Pin Configuration and Description

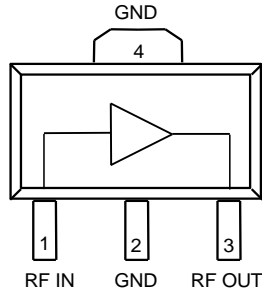

Pin No.	Label	Description
1	RF IN	RF Input. Requires external match for optimal performance. External DC Block required.
2, 4	GND	RF/DC Ground Connection
3	RF OUT	RF Output and V _{CC} . Requires external match for optimal performance. External DC Block, RF choke and supply voltage is required.

Evaluation Board PCB Information

Qorvo PCB 1080068 Material and Stack-up

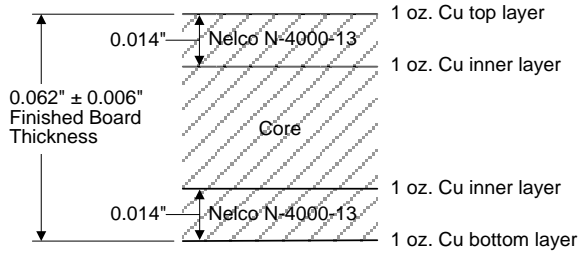

50 ohm line dimensions: width = .028", spacing = .028".

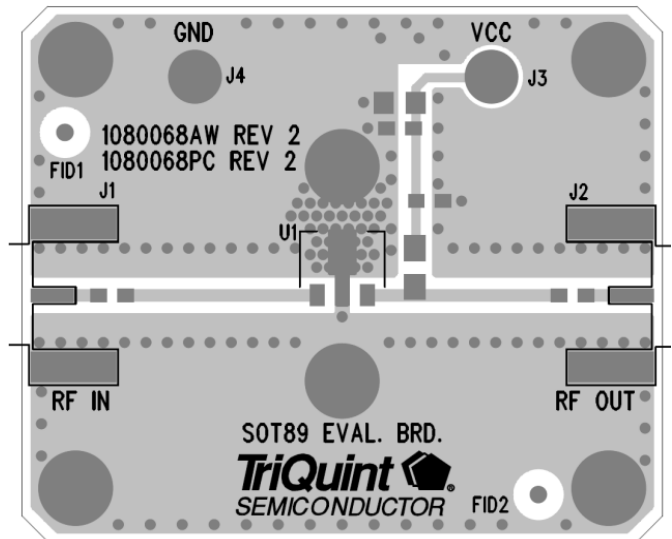

Package Marking and Dimensions

Marking:

Part Number – 7M9105
 Trace Code – XXXX

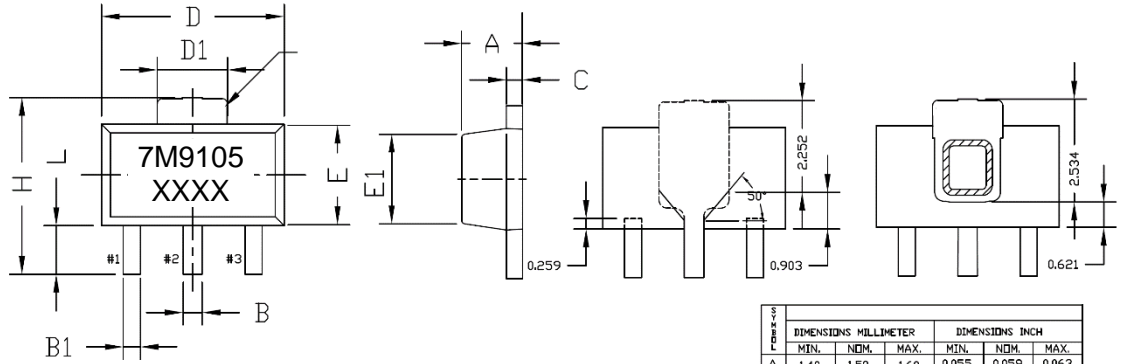

DIMENSIONS	DIMENSIONS MILLIMETER			DIMENSIONS INCH		
	MIN.	NOM.	MAX.	MIN.	NOM.	MAX.
A	1.40	1.50	1.60	0.055	0.059	0.063
B	0.42	0.49	0.56	0.017	0.019	0.022
B1	0.36	0.42	0.44	0.014	0.016	0.019
C	0.35	0.40	0.43	0.014	0.016	0.017
D	4.39	4.50	4.60	0.173	0.177	0.181
D1	1.40	1.62	1.83	0.055	0.062	0.072
E	2.29	2.44	2.60	0.090	0.098	0.102
E1	1.77	2.03	2.29	0.070	0.074	0.090
e	1.50 BSC			0.059 BSC		
e1	3.00 BSC			0.118 BSC		
H	3.84	4.04	4.25	0.151	0.155	0.167
L	0.74	0.97	1.20	0.029	0.041	0.047

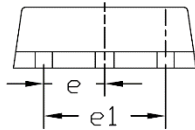

NOTES :
 1. DIMENSIONING & TOLERANCING PER ANSI Y14.5M-1982
 2. CONTROLLING DIMENSION : MILLIMETER CONVERTED INCH ARE NOT NECESSARILY EXACT.
 3. DIMENSION B1, 2 PLACES.

Notes:

1. The terminal #1 identifier and terminal numbering conform to JESD 95-1 SPP-012.
2. Trace code up to 4 characters assigned by subcontractor.
3. Contact plating: Annealed Matte Tin

PCB Mounting Pattern

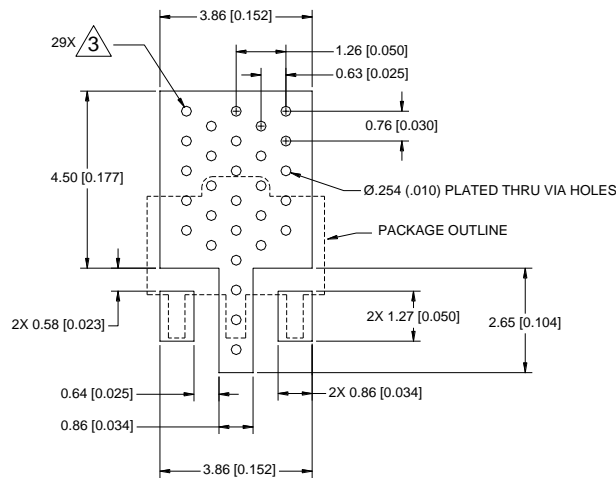

NOTES:

1. All dimensions are in millimeters [inches]. Angles are in degrees.
2. Use 1 oz. copper minimum for top and bottom layer metal.
3. Via holes are required under the backside paddle of this device for proper RF/DC grounding and thermal dissipation. We recommend a 0.35mm (#80/.0135") diameter bit for drilling via holes and a final plated thru diameter of 0.25mm (0.10").
4. Ensure good package backside paddle solder attach for reliable operation and best electrical performance.

Handling Precautions

Parameter	Rating	Standard
ESD – Human Body Model (HBM)	2	ESDA / JEDEC JS-001-2012
ESD – Charged Device Model (CDM)	C3	JEDEC JESD22-C101F
MSL – Moisture Sensitivity Level	Level 1	IPC/JEDEC J-STD-020



Caution!
ESD-Sensitive Device

Solderability

Compatible with both lead-free (260°C max. reflow temp.) and tin/lead (245°C max. reflow temp.) soldering processes. Solder profiles available upon request.

Contact plating: Annealed Matte Tin

RoHS Compliance

This part is compliant with 2011/65/EU RoHS directive (Restrictions on the Use of Certain Hazardous Substances in Electrical and Electronic Equipment) as amended by Directive 2015/863/EU.

This product also has the following attributes:

- Lead Free
- Halogen Free (Chlorine, Bromine)
- Antimony Free
- TBBP-A (C₁₅H₁₂Br₄O₂) Free
- SVHC Free



Contact Information

For the latest specifications, additional product information, worldwide sales and distribution locations:

Web: www.qorvo.com

Tel: 1-844-890-8163

Email: customer.support@qorvo.com

Important Notice

The information contained herein is believed to be reliable; however, Qorvo makes no warranties regarding the information contained herein and assumes no responsibility or liability whatsoever for the use of the information contained herein. All information contained herein is subject to change without notice. Customers should obtain and verify the latest relevant information before placing orders for Qorvo products. The information contained herein or any use of such information does not grant, explicitly or implicitly, to any party any patent rights, licenses, or any other intellectual property rights, whether with regard to such information itself or anything described by such information. **THIS INFORMATION DOES NOT CONSTITUTE A WARRANTY WITH RESPECT TO THE PRODUCTS DESCRIBED HEREIN, AND QORVO HEREBY DISCLAIMS ANY AND ALL WARRANTIES WITH RESPECT TO SUCH PRODUCTS WHETHER EXPRESS OR IMPLIED BY LAW, COURSE OF DEALING, COURSE OF PERFORMANCE, USAGE OF TRADE OR OTHERWISE, INCLUDING THE IMPLIED WARRANTIES OF MERCHANTABILITY AND FITNESS FOR A PARTICULAR PURPOSE.**

Without limiting the generality of the foregoing, Qorvo products are not warranted or authorized for use as critical components in medical, life-saving, or life-sustaining applications, or other applications where a failure would reasonably be expected to cause severe personal injury or death.

Copyright 2020 © Qorvo, Inc. | Qorvo is a registered trademark of Qorvo, Inc.