

## N-Channel and P-Channel Complementary Power MOSFET

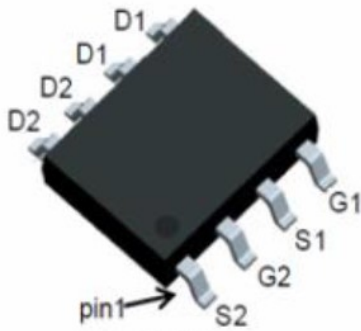

**SOP-8**

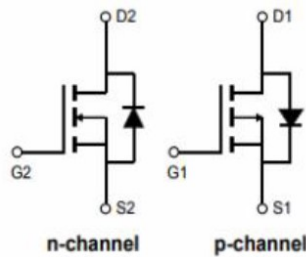
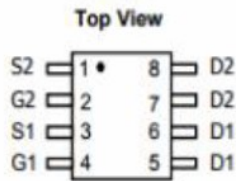

### Product Summary

#### NMOS

- $V_{DS}$  30V
- $I_D$  6A
- $R_{DS(ON)}$ ( at  $V_{GS}=10V$ ) <29mohm
- $R_{DS(ON)}$ ( at  $V_{GS}=4.5V$ ) <40mohm

#### PMOS

- $V_{DS}$  -30V
- $I_D$  -5A
- $R_{DS(ON)}$ ( at  $V_{GS}=-10V$ ) <55mohm
- $R_{DS(ON)}$ ( at  $V_{GS}=-4.5V$ ) <68mohm

- 100%  $\nabla V_{DS}$  Tested

### General Description

- Trench Power LV MOSFET technology
- High density cell design for low  $R_{DS(ON)}$
- High Speed switching

### Applications

- Wireless charger
- Load switch
- Power management

### ■ Absolute Maximum Ratings ( $T_A=25^\circ C$ unless otherwise noted)

Parameter		Symbol	N-Channel	P-Channel	Unit
Drain-source Voltage		$V_{DS}$	30	-30	V
Gate-source Voltage		$V_{GS}$	$\pm 20$	$\pm 20$	V
Drain Current	$T_A=25^\circ C$	$I_D$	6	-5	A
	$T_A=70^\circ C$		4.8	-4	
Pulsed Drain Current <sup>A</sup>		$I_{DM}$	24	-20	A
Total Power Dissipation	$T_A=25^\circ C$	$P_D$	2	2	W
	$T_A=70^\circ C$		1.2	1.2	W
Thermal Resistance Junction-to-Ambient <sup>B</sup>		$R_{\theta JA}$	62.5	62.5	$^\circ C/W$
Junction and Storage Temperature Range		$T_J, T_{STG}$	-55~+150	-55~+150	$^\circ C$

### ■ Ordering Information (Example)

PREFERRED P/N	PACKING CODE	Marking	MINIMUM PACKAGE(pcs)	INNER BOX QUANTITY(pcs)	OUTER CARTON QUANTITY(pcs)	DELIVERY MODE
YJS4606A	F2	YJS4606A	4000	8000	64000	13" reel



# YJS4606A

## ■ N-MOS Electrical Characteristics ( $T_J=25^{\circ}\text{C}$ unless otherwise noted)

Parameter	Symbol	Conditions	Min	Typ	Max	Units
<b>Static Parameter</b>						
Drain-Source Breakdown Voltage	$BV_{DSS}$	$V_{GS}=0V, I_D=250\mu A$	30			V
Zero Gate Voltage Drain Current	$I_{DSS}$	$V_{DS}=30V, V_{GS}=0V$			1	$\mu A$
Gate-Body Leakage Current	$I_{GSS}$	$V_{GS}=\pm 20V, V_{DS}=0V$			$\pm 100$	nA
Gate Threshold Voltage	$V_{GS(th)}$	$V_{DS}=V_{GS}, I_D=250\mu A$	1.0	1.5	2.2	V
Static Drain-Source On-Resistance	$R_{DS(on)}$	$V_{GS}=10V, I_D=6A$		21	29	m $\Omega$
		$V_{GS}=4.5V, I_D=5A$		27	40	
Diode Forward Voltage	$V_{SD}$	$I_S=6A, V_{GS}=0V$			1.2	V
<b>Dynamic Parameters</b>						
Input Capacitance	$C_{iss}$	$V_{DS}=15V, V_{GS}=0V, f=1\text{MHZ}$		526		pF
Output Capacitance	$C_{oss}$			78		
Reverse Transfer Capacitance	$C_{rss}$			69		
<b>Switching Parameters</b>						
Total Gate Charge	$Q_g$	$V_{GS}=10V, V_{DS}=15V, I_D=5.6A$		12.22		nC
Gate-Source Charge	$Q_{gs}$			2.37		
Gate-Drain Charge	$Q_{gd}$			2.31		
Reverse Recovery Charge	$Q_{rr}$	$I_F=5.6A, di/dt=100A/\mu s$		1.28		ns
Reverse Recovery Time	$t_{rr}$			16.5		
Turn-on Delay Time	$t_{D(on)}$	$V_{GS}=10V, V_{DS}=15V, I_D=5.6A$ $R_{GEN}=3\Omega$		5		ns
Turn-on Rise Time	$t_r$			28.2		
Turn-off Delay Time	$t_{D(off)}$			12.8		
Turn-off fall Time	$t_f$			21.6		

A. Pulse Test: Pulse Width  $\leq 300\mu s$ , Duty cycle  $\leq 2\%$ .

B.  $R_{\theta JA}$  is the sum of the junction-to-case and case-to-ambient thermal resistance, where the case thermal reference is defined as the solder mounting surface of the drain pins.  $R_{\theta JC}$  is guaranteed by design, while  $R_{\theta JA}$  is determined by the board design. The maximum rating presented here is based on mounting on a 1 in 2 pad of 2oz copper.



# YJS4606A

## ■ P-MOS Electrical Characteristics ( $T_J=25^\circ\text{C}$ unless otherwise noted)

Parameter	Symbol	Conditions	Min	Typ	Max	Units
<b>Static Parameter</b>						
Drain-Source Breakdown Voltage	$BV_{DSS}$	$V_{GS}=0V, I_D=-250\mu A$	-30			V
Zero Gate Voltage Drain Current	$I_{DSS}$	$V_{DS}=-30V, V_{GS}=0V$			-1	$\mu A$
Gate-Body Leakage Current	$I_{GSS}$	$V_{GS}=\pm 20V, V_{DS}=0V$			$\pm 100$	nA
Gate Threshold Voltage	$V_{GS(th)}$	$V_{DS}=V_{GS}, I_D=-250\mu A$	-1.0	-1.5	-2.4	V
Static Drain-Source On-Resistance	$R_{DS(on)}$	$V_{GS}=-10V, I_D=-5A$		40	55	m $\Omega$
		$V_{GS}=-4.5V, I_D=-3.5A$		53	68	
Diode Forward Voltage	$V_{SD}$	$I_S=-5A, V_{GS}=0V$			-1.2	V
<b>Dynamic Parameters</b>						
Input Capacitance	$C_{iss}$	$V_{DS}=-15V, V_{GS}=0V, f=1\text{MHz}$		719		pF
Output Capacitance	$C_{oss}$			78		
Reverse Transfer Capacitance	$C_{rss}$			64		
<b>Switching Parameters</b>						
Total Gate Charge	$Q_g$	$V_{GS}=-10V, V_{DS}=-15V, I_D=-5.1A$		14.23		nC
Gate-Source Charge	$Q_{gs}$			3.16		
Gate-Drain Charge	$Q_{gd}$			2		
Reverse Recovery Charge	$Q_{rr}$	$I_F=-5.1A, di/dt=100A/\mu s$		5.3		ns
Reverse Recovery Time	$t_{rr}$			30		
Turn-on Delay Time	$t_{D(on)}$	$V_{GS}=-10V, V_{DS}=-15V, I_D=5.1A$ $R_{GEN}=3\Omega$		7.4		ns
Turn-on Rise Time	$t_r$			37		
Turn-off Delay Time	$t_{D(off)}$			31.6		
Turn-off fall Time	$t_f$			42		

C. Pulse Test: Pulse Width  $\leq 300\mu s$ , Duty cycle  $\leq 2\%$ .

D.  $R_{\theta JA}$  is the sum of the junction-to-case and case-to-ambient thermal resistance, where the case thermal reference is defined as the solder mounting surface of the drain pins.  $R_{\theta JC}$  is guaranteed by design, while  $R_{\theta JA}$  is determined by the board design. The maximum rating presented here is based on mounting on a 1 in 2 pad of 2oz copper.



■ N-MOS Typical Performance Characteristics

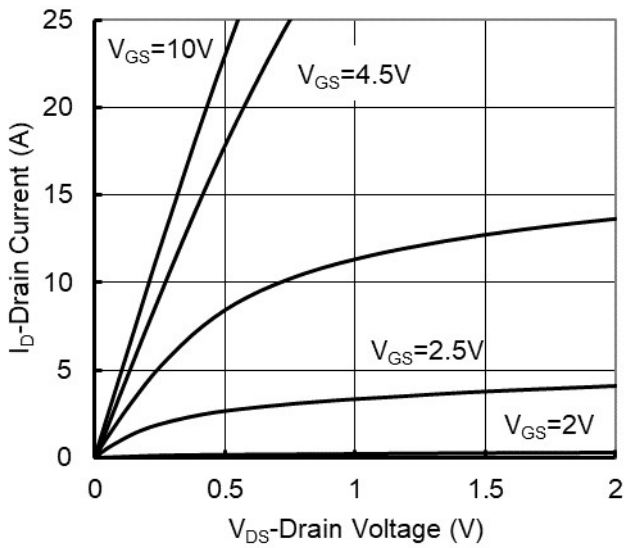

Figure1. Output Characteristics

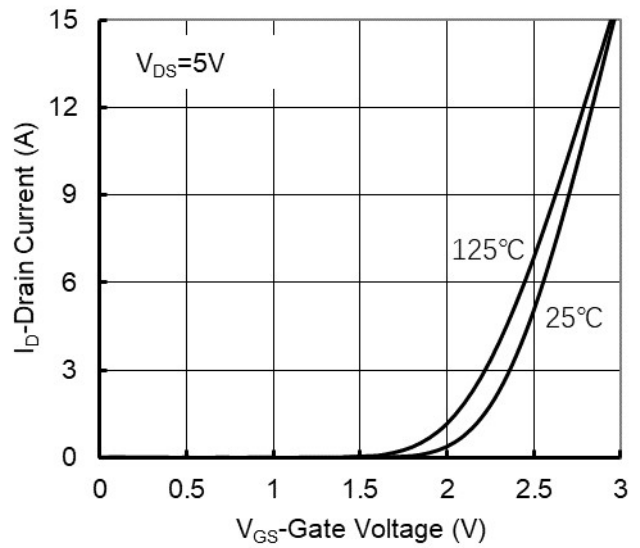

Figure2. Transfer Characteristics

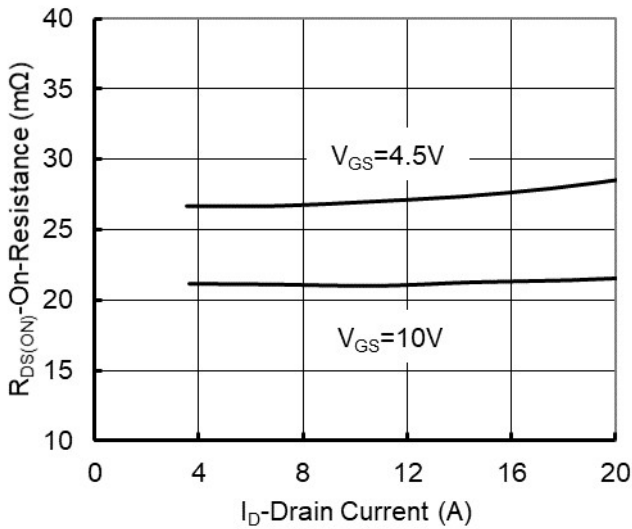

Figure 3: On-Resistance vs. Drain Current and Gate Voltage

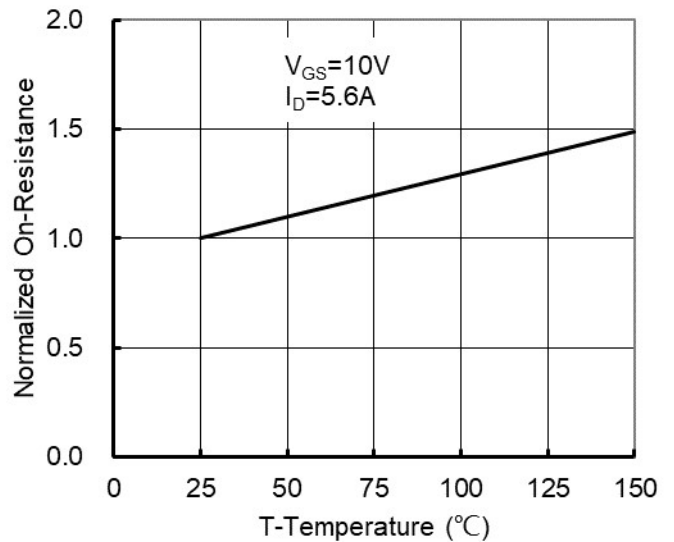

Figure 4: On-Resistance vs. Junction Temperature

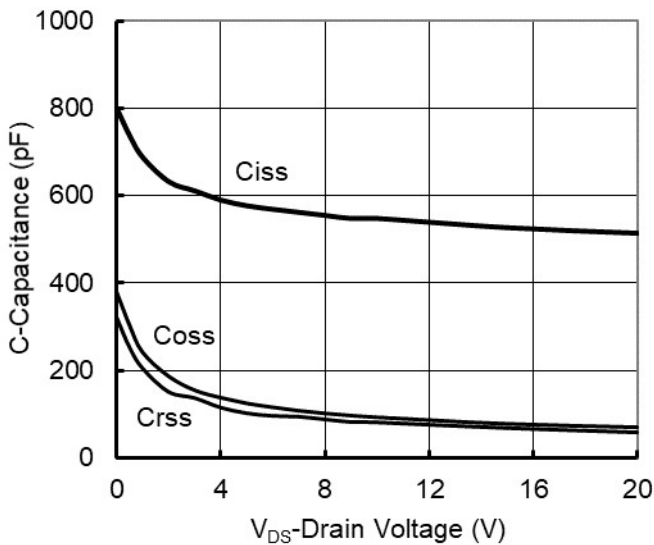

Figure5. Capacitance Characteristics

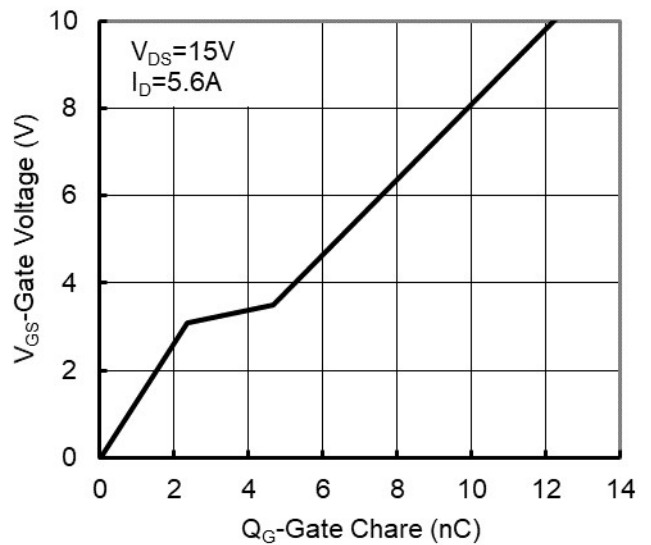

Figure6. Gate Charge



# YJS4606A

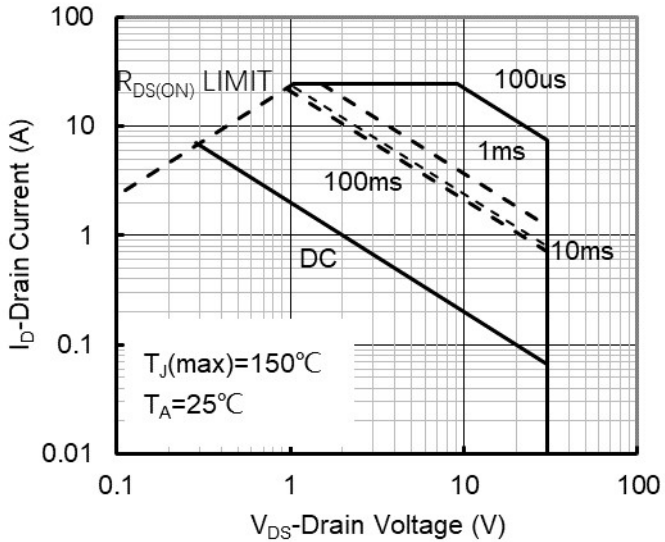

Figure7. Safe Operation Area

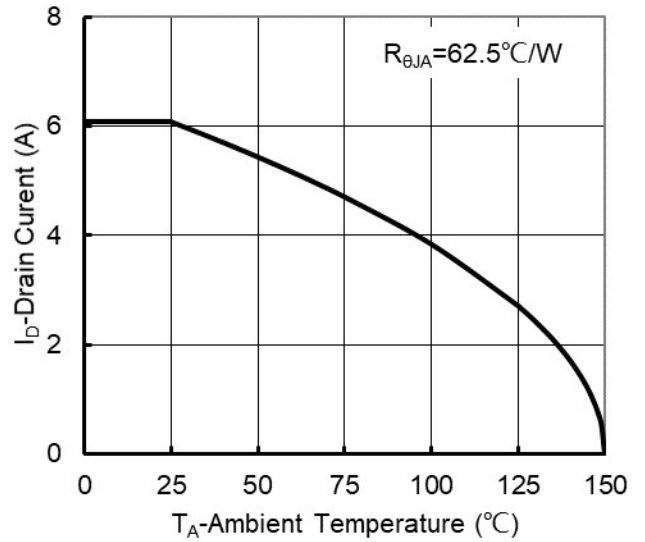

Figure8. Maximum Continuous Drain Current vs Ambient Temperature

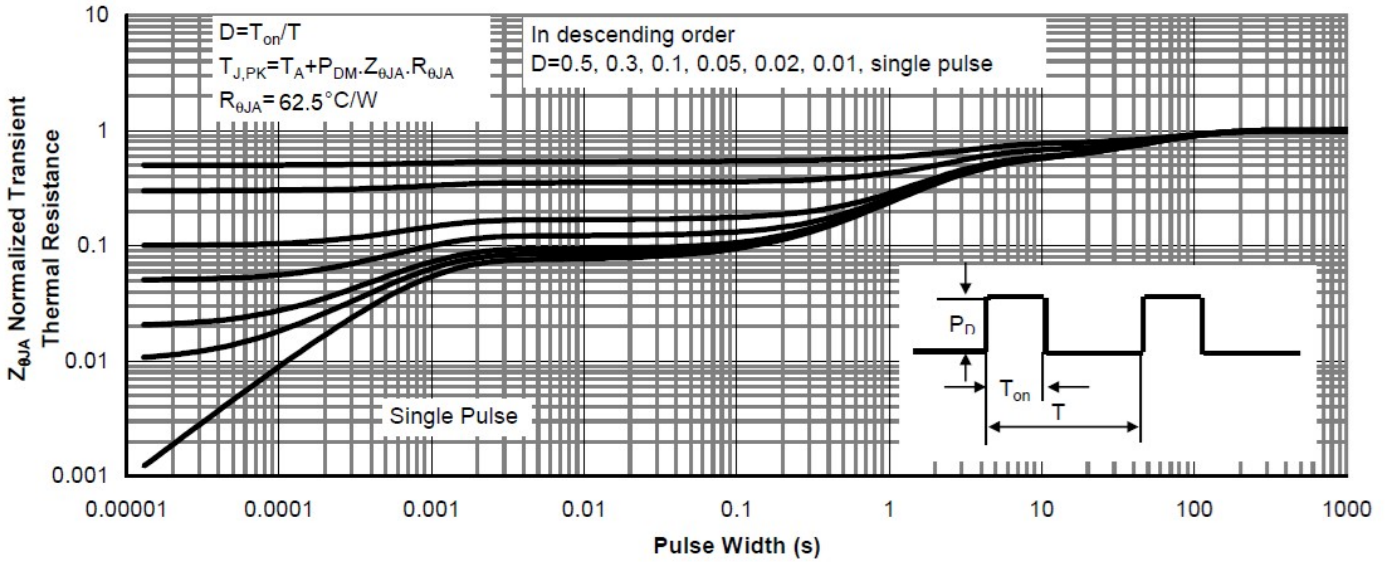

Figure9. Normalized Maximum Transient Thermal Impedance



■ P-MOS Typical Performance Characteristics

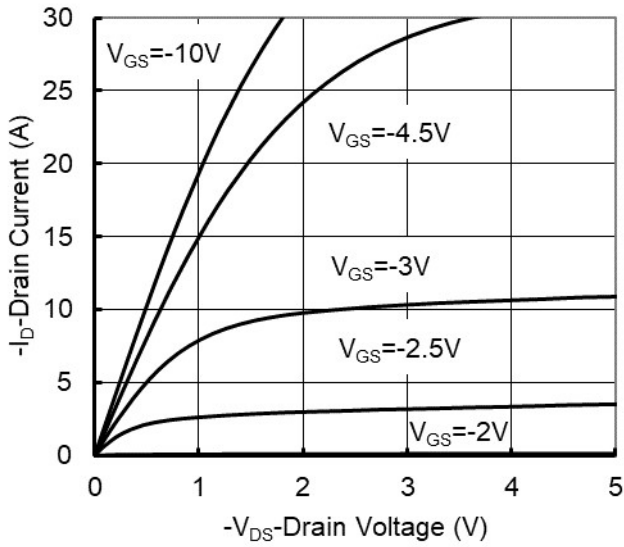

Figure1. Output Characteristics

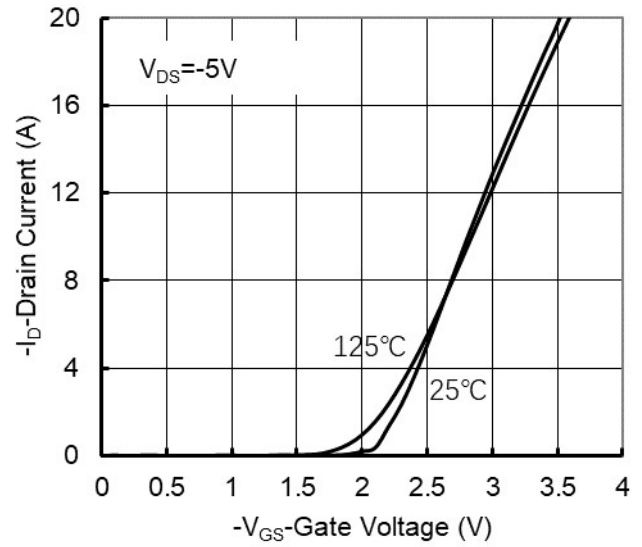

Figure2. Transfer Characteristics

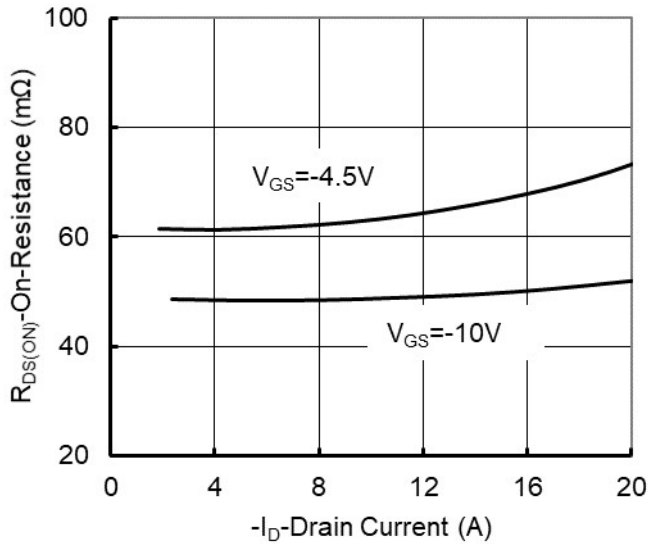

Figure 3: On-Resistance vs. Drain Current and Gate Voltage

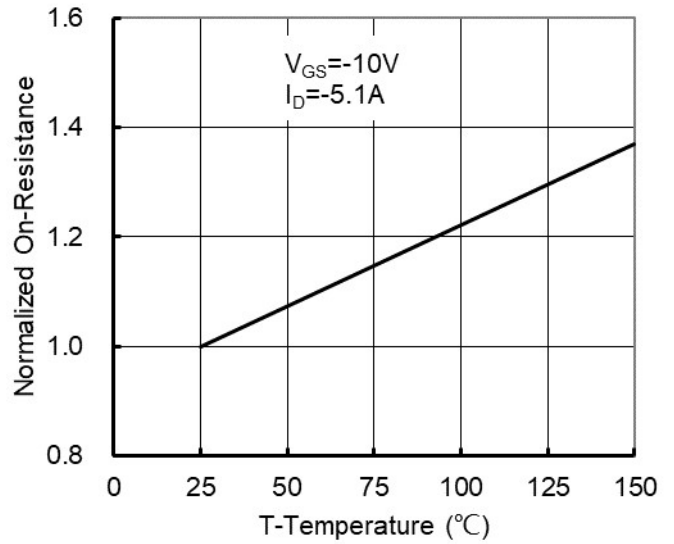

Figure 4: On-Resistance vs. Junction Temperature

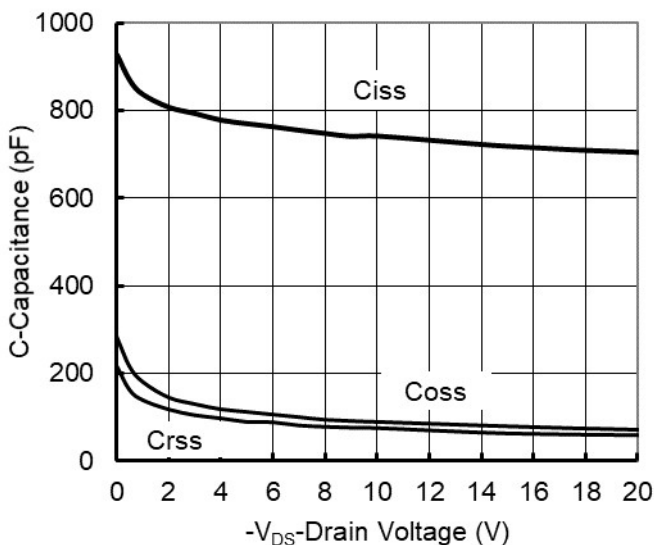

Figure5. Capacitance Characteristics

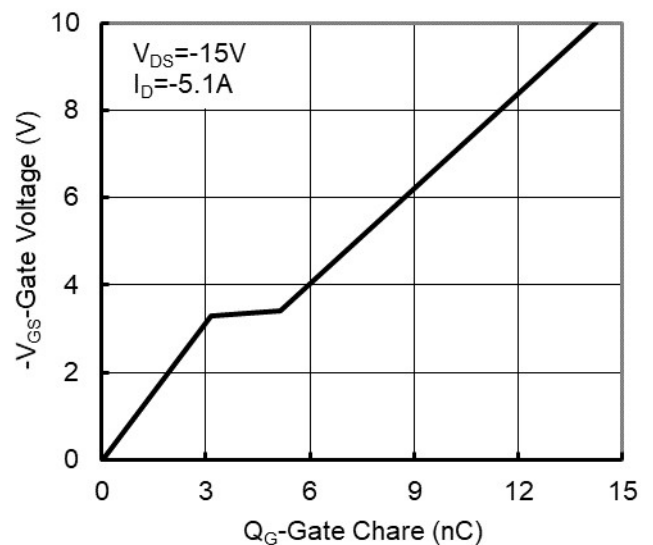

Figure6. Gate Charge



# YJS4606A

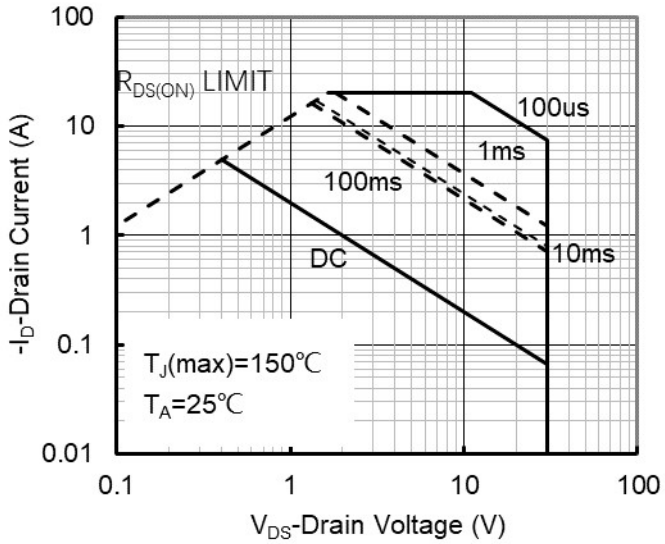

Figure7. Safe Operation Area

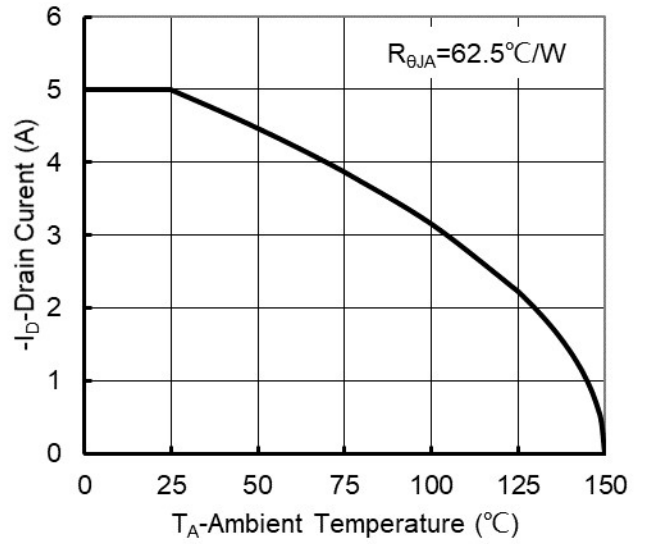

Figure8. Maximum Continuous Drain Current vs Ambient Temperature

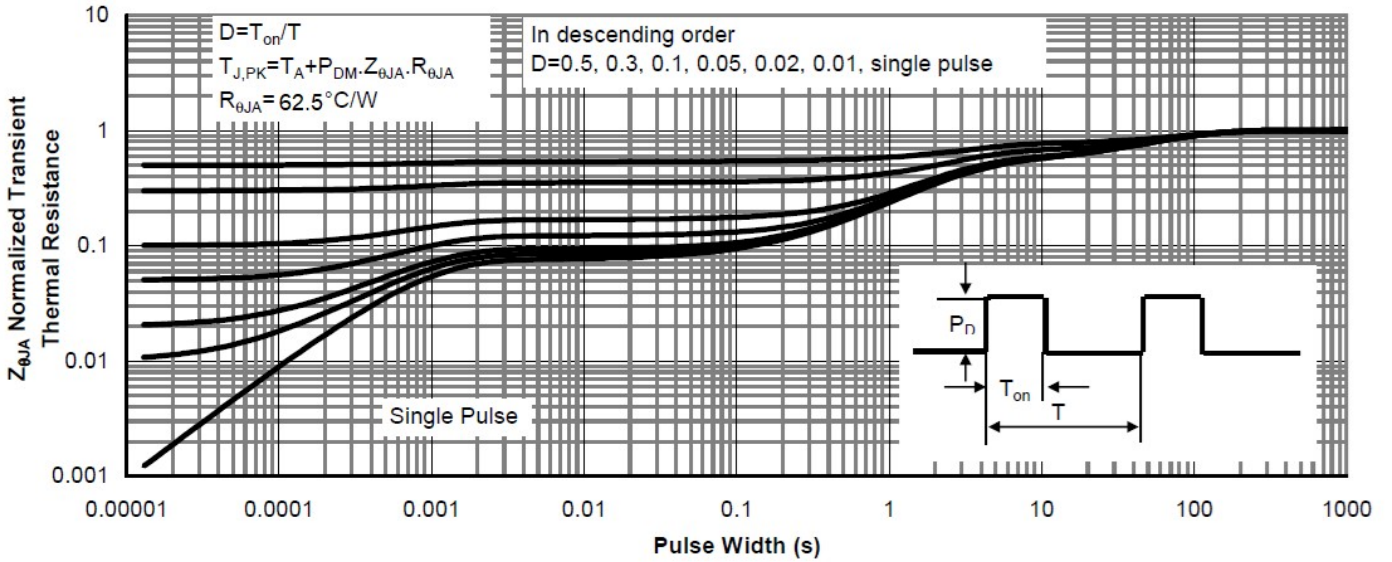
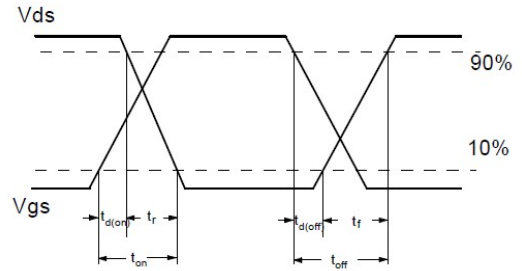
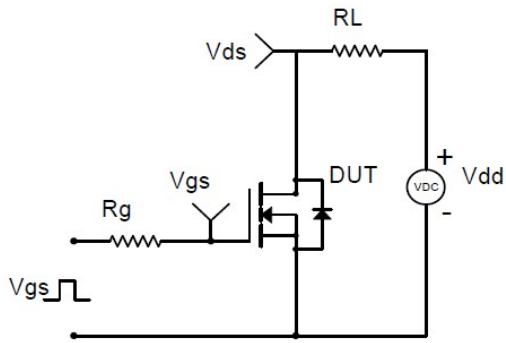
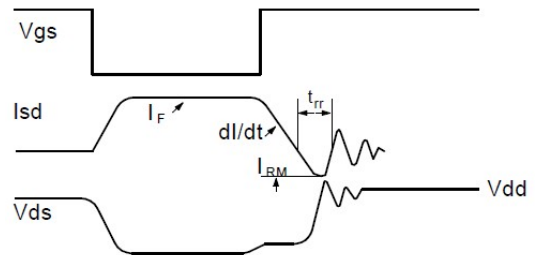
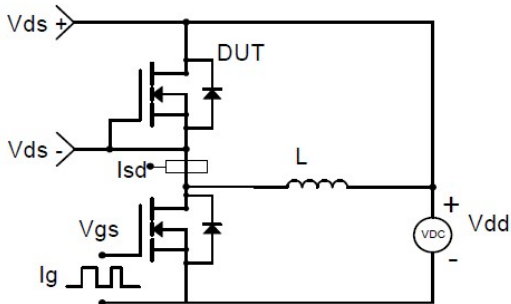

Figure9. Normalized Maximum Transient Thermal Impedance



**Resistive Switching Test Circuit & Waveforms**



**Diode Recovery Test Circuit & Waveforms**

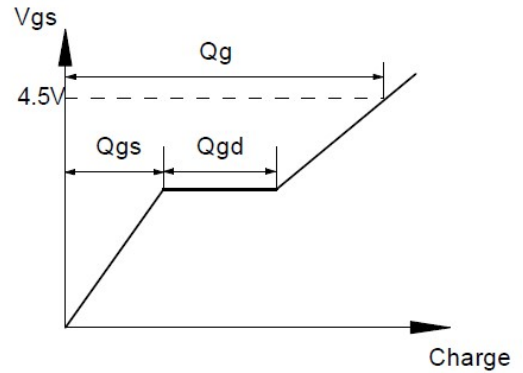
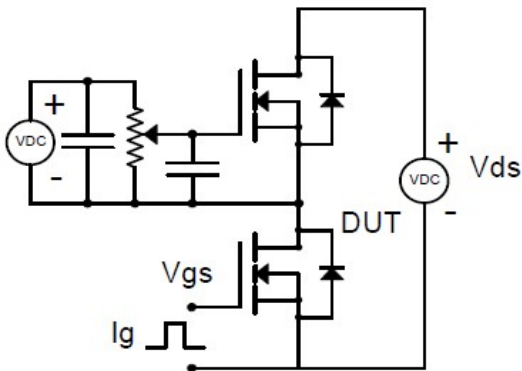

**Gate Charge Test Circuit & Waveform**

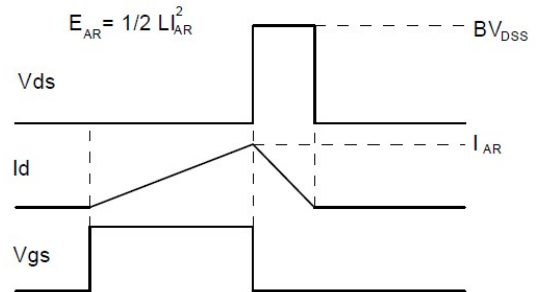
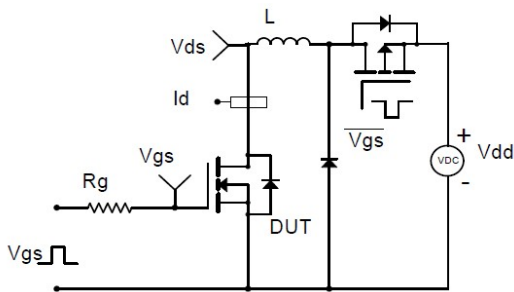

**Unclamped Inductive Switching (UIS) Test Circuit & Waveforms**





# YJS4606A

## ■ SOP-8 Package information

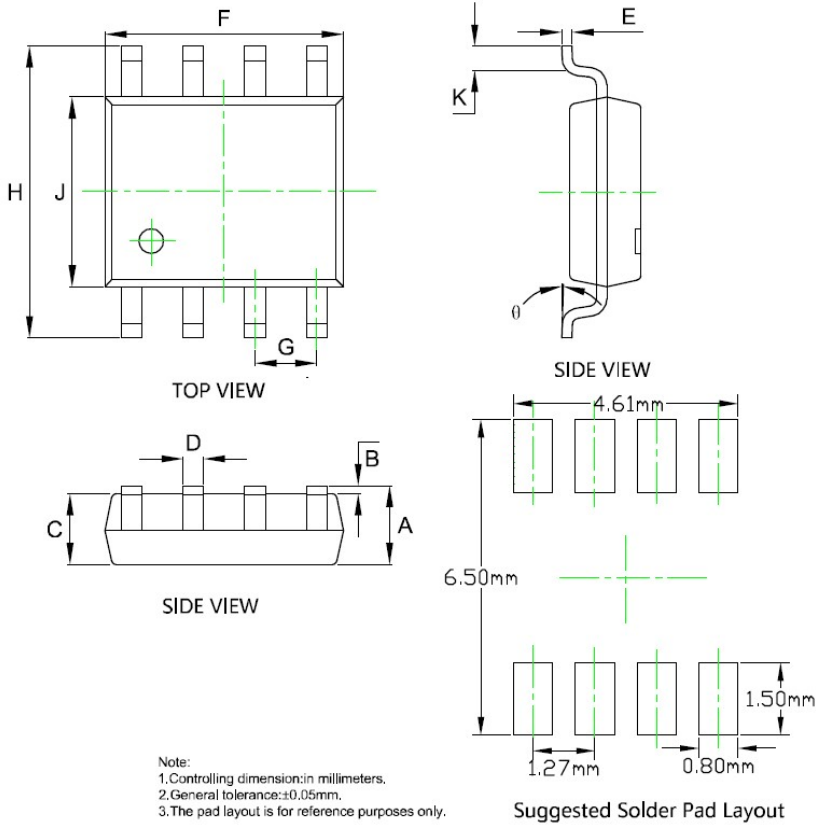

SYMBOL	DIMENSIONS			
	INCHES		Millimeter	
	MIN.	MAX.	MIN.	MAX.
A	0.053	0.069	1.350	1.750
B	0.004	0.010	0.100	0.250
C	0.053	0.061	1.350	1.550
D	0.013	0.020	0.330	0.510
E	0.007	0.010	0.170	0.250
F	0.189	0.197	4.800	5.000
G	0.050BSC		1.270BSC	
H	0.228	0.244	5.800	6.200
J	0.150	0.157	3.800	4.000
K	0.016	0.050	0.400	1.270
θ	0°	8°	0°	8°



## YJS4606A

---

### Disclaimer

The information presented in this document is for reference only. Yangzhou Yangjie Electronic Technology Co., Ltd. reserves the right to make changes without notice for the specification of the products displayed herein to improve reliability, function or design or otherwise.

The product listed herein is designed to be used with ordinary electronic equipment or devices, and not designed to be used with equipment or devices which require high level of reliability and the malfunction of which would directly endanger human life (such as medical instruments, transportation equipment, aerospace machinery, nuclear-reactor controllers, fuel controllers and other safety devices), Yangjie or anyone on its behalf, assumes no responsibility or liability for any damages resulting from such improper use of sale.

This publication supersedes & replaces all information previously supplied. For additional information, please visit our website [http:// www.21yangjie.com](http://www.21yangjie.com) , or consult your nearest Yangjie's sales office for further assistance.