

HSF

NOTES:
 Current Rating:18A
 Voltage Rating:300V
 Contact Resistance:8milliohm Max
 Withstand Voltage:AC2000V
 Insulation Resistance:1000Megohm Min
 Screw Torque: 4.4 lbf.in
 Wire range: 12-30AWG
 Operation Temperature: -40℃ to +105℃

Housing Material:PA66 UL94V-0
 Cover Material:PA66 UL94-V0
 Screw:Steel
 Pin Block:Brass
 Contact:Phosphor Bronze

2P With 1 RAMP Locking "A"

Ordering Information:

P F 508 - A XX A SM N 1
 F=Female Pitch 508=5.08
 No.of Pins 02-24P
 Color A=Green
 Contact Plated SM=Matte Tin
 Type N=Without Two Side Screw

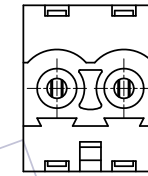
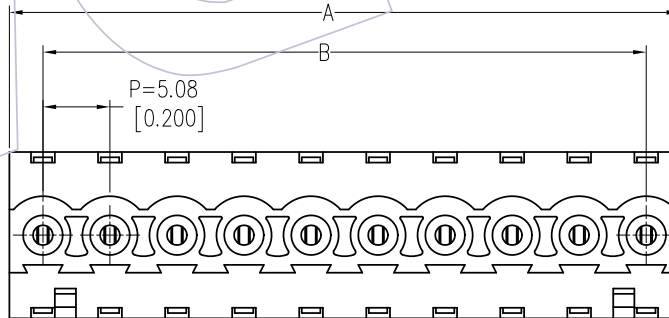
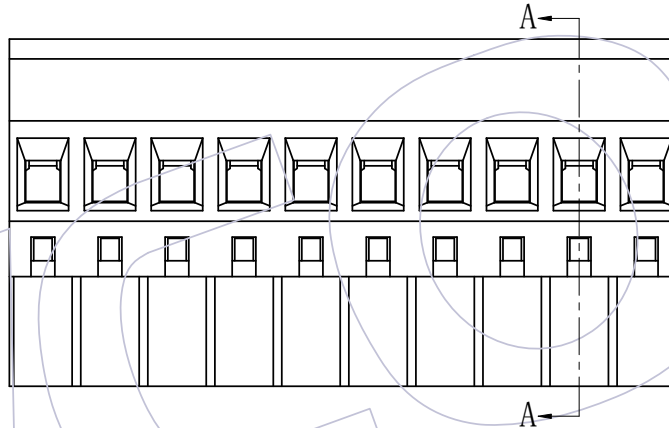
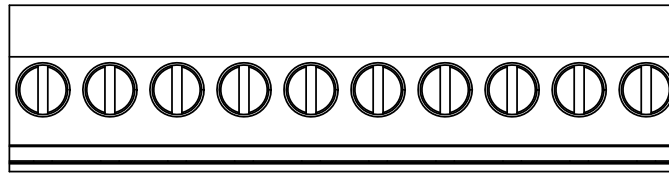

2 Pin

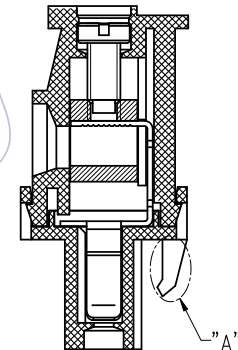
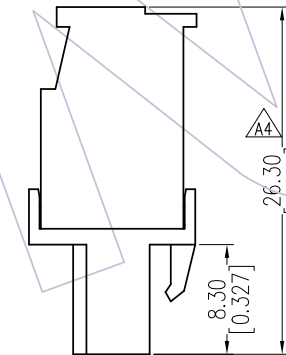

Section A-A

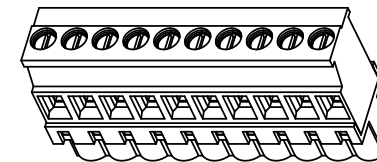

13P	66.04 ±0.30	60.96 ±0.30			
12P	60.96 ±0.30	55.88 ±0.30	24P	121.92 ±0.50	116.84 ±0.50
11P	55.88 ±0.30	50.80 ±0.30	23P	116.84 ±0.50	111.76 ±0.50
10P	50.80 ±0.30	45.72 ±0.30	22P	111.76 ±0.50	106.68 ±0.50
9P	45.72 ±0.30	40.64 ±0.30	21P	106.68 ±0.50	101.60 ±0.50
8P	40.64 ±0.30	35.56 ±0.30	20P	101.60 ±0.50	96.52 ±0.50
7P	35.56 ±0.20	30.48 ±0.20	19P	96.52 ±0.40	91.44 ±0.40
6P	30.48 ±0.20	25.40 ±0.20	18P	91.44 ±0.40	86.36 ±0.40
5P	25.40 ±0.20	20.32 ±0.20	17P	86.36 ±0.40	81.28 ±0.40
4P	20.32 ±0.20	15.24 ±0.20	16P	81.28 ±0.40	76.20 ±0.40
3P	15.24 ±0.20	10.16 ±0.20	15P	76.20 ±0.40	71.12 ±0.40
2P	10.16 ±0.20	5.08 ±0.10	14P	71.12 ±0.40	66.04 ±0.40
PIN	A	B	PIN	A	B

REV	DATE	MODIFICATION DESCRIPTION	CHANGE	OPERATION	DRAW	DATE	SCALE	FIT	PART NO.
A4	2019/06/05	Modify 26.0 to 26.30		OPERATION	DRAW	2019/06/05	SCALE	FIT	PF508-AXXASMN1
A3	2015/12/15	Modify		X.X ±0.40	XSR		UNIT	mm	TITLE: 5.08mm Pitch Female Pluggable Terminal Blocks
A2	2015/07/15	Modify		X.XX ±0.25	CHECK	DATE	SIZE	A4	
A0	2011/06/08	NEW		X.XXX ±0.15	APPROVE	DATE	SHEET	1/1	Customer NO.
				Angle ± 3°			PROJ.		
				DIM TOL					

WCON

Http: www.wcon.com

WCON-Dongguan Tel: +86 769 85358920
 Fax: +86 769 85358915
 E-mail: sales@wcon.com
 WCON-Kunshan Tel: +86 512 57468408
 Fax: +86 512 57468468
 E-mail: salesks@wcon.com