

DATA SHEET

ANTI-SULFURATED CHIP RESISTORS

AF series
5%, 1%, 0.5%

sizes 0201/0402/0603/0805/1206/1210/1218/2010/2512

RoHS compliant & Halogen free



SCOPE

This specification describes AF0201 to AF2512 chip resistors with anti-sulfuration capabilities.

APPLICATIONS

- Industrial Equipment
- Power Application
- Networking Application
- High-end Computer & Multimedia Electronics in high sulfur environment
- Automotive electronics

FEATURES

- AEC-Q200 qualified
- Superior resistance against sulfur containing atmosphere
- Halogen free product and production
- RoHS compliant
- Reduces environmentally hazardous waste
- High component and equipment reliability
- Saving of PCB space
- Moisture sensitivity level: MSL 1

ORDERING INFORMATION - GLOBAL PART NUMBER

Part number is identified by the series name, size, tolerance, packaging type, temperature coefficient, taping reel and resistance value.

GLOBAL PART NUMBER

AF XXXX X X X XX XXXX L
 (1) (2) (3) (4) (5) (6) (7)

(1) SIZE

0201/0402/0603/0805/1206/1210/1218/2010/2512

(2) TOLERANCE

- D = ±0.5%
- F = ±1%
- J = ±5% (for jumper ordering, use code of J)

(3) PACKAGING TYPE

- R = Paper taping reel
- K = Embossed plastic tape reel

(4) TEMPERATURE COEFFICIENT OF RESISTANCE

– = Base on spec

(5) TAPING REEL

- 07 = 7 inch dia. Reel
- 13 = 13 inch dia. Reel

(6) RESISTANCE VALUE

There are 2~4 digits indicated the resistance value. Letter R/K/M is decimal point. Detailed resistance rules are displayed in the table of "Resistance rule of global part number".

(7) DEFAULT CODE

Letter L is system default code for ordering only ^(Note)

Resistance rule of global part number	
Resistance coding rule	Example
X \overline{R} XX (1 to 9.76 Ω)	1R = 1 Ω 1R5 = 1.5 Ω 9R76 = 9.76 Ω
XX \overline{R} X (10 to 97.6 Ω)	10R = 10 Ω 97R6 = 97.6 Ω
XXX \overline{R} (100 to 976 Ω)	100R = 100 Ω
XKXX (1 to 9.76 K Ω)	1K = 1,000 Ω 9K76 = 9760 Ω
XMXX (1 to 9.76 M Ω)	1M = 1,000,000 Ω 9M76 = 9,760,000 Ω

ORDERING EXAMPLE

The ordering code for an AF0402 chip resistor, value 100 K Ω with ±1% tolerance, supplied in 7-inch tape reel with 10Kpcs quantity is: AF0402FR-07100KL.

NOTE

1. All our R-Chip products are RoHS compliant and Halogen free. "LFP" of the internal 2D reel label states "Lead-Free Process"
2. On customized label, "LFP" or specific symbol can be printed

MARKING

AF0201 / AF0402

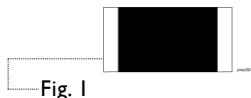

No marking

Fig. 1

AF0603 / AF0805 / AF1206 / AF1210 / AF2010 / AF2512



E-24 series: 3 digits, $\pm 5\%$, $\geq 10\Omega$
 First two digits for significant figure and 3rd digit for number of zeros

Fig. 2 Value = 10 K Ω

AF0603



E-24 series: 3 digits, $\pm 1\%$
 One short bar under marking letter

Fig. 3 Value = 24 Ω

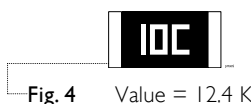

E-96 series: 3 digits, $\pm 1\%$
 First two digits for E-96 marking rule and 3rd letter for number of zeros

Fig. 4 Value = 12.4 K Ω

AF0805 / AF1206 / AF1210 / AF2010 / AF2512

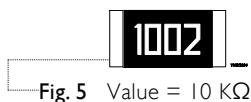

Both E-24 and E-96 series: 4 digits, $\pm 1\%$
 First three digits for significant figure and 4th digit for number of zeros

Fig. 5 Value = 10 K Ω

AF1218

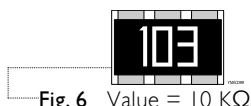

E-24 series: 3 digits, $\pm 5\%$
 First two digits for significant figure and 3rd digit for number of zeros

Fig. 6 Value = 10 K Ω

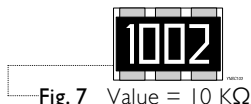

Both E-24 and E-96 series: 4 digits, $\pm 1\%$
 First three digits for significant figure and 4th digit for number of zeros

Fig. 7 Value = 10 K Ω

NOTE

For further marking information, please see special data sheet "Chip resistors marking". Marking of AF series is the same as RC series

CONSTRUCTION

The resistors are constructed on top of a high grade ceramic body. Internal metal electrodes are added at each end and connected by a resistive glaze. The resistive glaze is covered by a glass.

The composition of the glaze is adjusted to give the approximate required resistance value and laser trimming of this resistive glaze achieves the value within tolerance.

The whole element is covered by a protective overcoat. Size 0603 and bigger is marked with the resistance value on top. Finally, the two external terminations (Ni / matte tin) are added. See fig.8

DIMENSIONS

Table I For outlines see fig. 8

TYPE	L (mm)	W (mm)	H (mm)	I ₁ (mm)	I ₂ (mm)
AF0201	0.60±0.03	0.30±0.03	0.23±0.03	0.12±0.05	0.15±0.05
AF0402	1.00±0.05	0.50±0.05	0.32±0.05	0.20±0.10	0.25±0.10
AF0603	1.60±0.10	0.80±0.10	0.45±0.10	0.25±0.15	0.25±0.15
AF0805	2.00±0.10	1.25±0.10	0.50±0.10	0.35±0.20	0.35±0.20
AF1206	3.10±0.10	1.60±0.10	0.55±0.10	0.45±0.20	0.40±0.20
AF1210	3.10±0.10	2.60±0.15	0.55±0.10	0.45±0.15	0.50±0.20
AF1218	3.10±0.10	4.60±0.10	0.55±0.10	0.45±0.20	0.40±0.20
AF2010	5.00±0.10	2.50±0.15	0.55±0.10	0.55±0.15	0.50±0.20
AF2512	6.35±0.10	3.10±0.15	0.55±0.10	0.60±0.20	0.50±0.20

OUTLINES

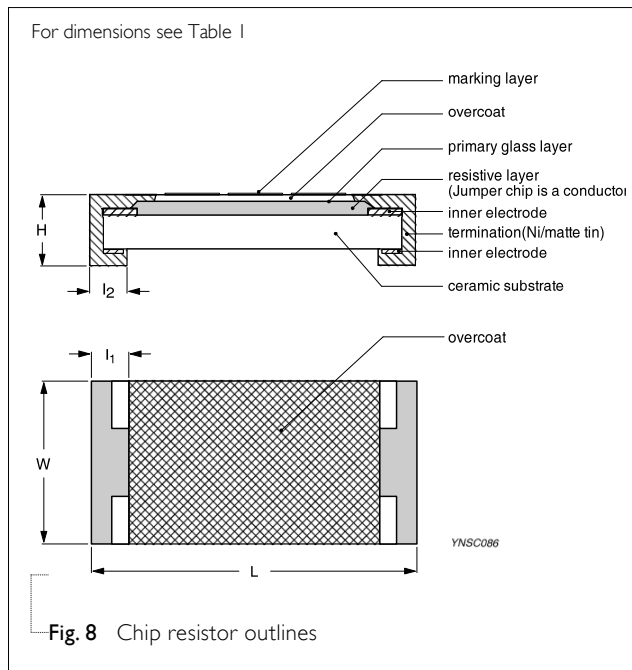

ELECTRICAL CHARACTERISTICS

Table 2

TYPE	RESISTANCE RANGE	CHARACTERISTICS					
		Operating Temperature Range	Max. Working Voltage	Max. Overload Voltage	Dielectric Withstanding Voltage	Temperature Coefficient of Resistance	Jumper Criteria
AF0201	±5% (E24), 1Ω to 10MΩ	-55 °C to +155 °C	25 V	50 V	50 V	1Ω ≤ R ≤ 10Ω, -100/+350 ppm/°C 10Ω < R ≤ 10MΩ, ±200 ppm/°C	Rated Current 0.5A
	±0.5%, ±1% (E24/E96), 1Ω to 10MΩ Zero Ohm Jumper < 0.05Ω						Max. Current 1.0A
AF0402			50 V	100 V	100 V		Rated Current 1.0A
AF0603			75 V	150 V	150 V		Max. Current 2.0A
AF0805	±5% (E24), 1Ω to 22 MΩ	-55 °C to +155 °C	150 V	300 V	300 V	1Ω ≤ R ≤ 10Ω, ±200 ppm/°C 10Ω < R ≤ 10 MΩ, ±100 ppm/°C 10 MΩ < R ≤ 22 MΩ, ±200 ppm/°C	Rated Current 2.0A
	±0.5%, ±1% (E24/E96), 1Ω to 10 MΩ Zero Ohm Jumper < 0.05 Ω						Max. Current 5.0A
AF1206			200 V	400 V	500 V		Rated Current 2.0A Max. Current 10.0A
AF1210	±5% (E24), 1Ω to 10MΩ	-55 °C to +155 °C	200 V	500 V	500 V		Rated Current 2.0A
	± 0.5%, ±1% (E24/E96), 1Ω to 10M Zero Ohm Jumper < 0.05Ω						Max. Current 10.0A
AF1218	±5% (E24), 1Ω to 1MΩ	-55 °C to +155 °C	200 V	500 V	500 V	1Ω ≤ R ≤ 10Ω, ±200 ppm/°C 10Ω < R ≤ 10MΩ, ±100 ppm/°C	Rated Current 2.0A
	± 0.5%, ±1% (E24/E96), 1Ω to 1M Zero Ohm Jumper < 0.05Ω						Max. Current 10.0A
AF2010	±5% (E24), 1Ω to 10MΩ		200 V	500 V	500 V		Rated Current 2.0A
AF2512	± 0.5%, ±1% (E24/E96), 1Ω to 10M Zero Ohm Jumper < 0.05Ω		200V	500V	500V		Max. Current 10.0A

FOOTPRINT AND SOLDERING PROFILES

For recommended footprint and soldering profiles of AF-series is the same as RC-series. Please see the special data sheet “Chip resistors mounting”.

PACKING STYLE AND PACKAGING QUANTITY

Table 3 Packing style and packaging quantity

PACKING STYLE	REEL DIMENSION	AF0201	AF0402	AF0603/0805/1206	AF1210	AF1218/2010/2512
Paper taping reel (R)	7" (178 mm)	10,000/20,000	10,000/20,000	5,000	5,000	--
	13" (330 mm)	50,000	50,000	20,000	20,000	--
Embossed taping reel (K)	7" (178 mm)	--	--	--	--	4,000

NOTE

I. For paper/embossed tape and reel specification/dimensions, please see the special data sheet “Chip resistors packing”.

FUNCTIONAL DESCRIPTION

OPERATING TEMPERATURE RANGE

AF0201 - AF2512 Range:
-55 °C to + 155 °C (Fig. 7)

POWER RATING

Each type rated power at 70 °C:

- AF0201=1/20W (0.05W)
- AF0402=1/16 W (0.0625W)
- AF0603=1/10 W (0.1W)
- AF0805=1/8 W (0.125W)
- AF1206=1/4 W (0.25W)
- AF1210=1/2W (0.5W)
- AF1218=1W
- AF2010=3/4W (0.75W)
- AF2512=1W

RATED VOLTAGE

The DC or AC (rms) continuous working voltage corresponding to the rated power is determined by the following formula:

$$V = \sqrt{(P \times R)}$$

Where

V = Continuous rated DC or AC (rms) working voltage (V)

P = Rated power (W)

R = Resistance value (Ω)

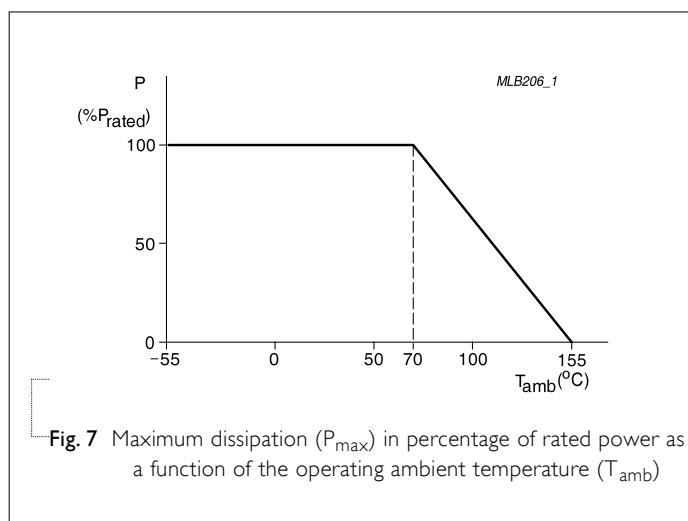

Fig. 7 Maximum dissipation (P_{max}) in percentage of rated power as a function of the operating ambient temperature (T_{amb})

TESTS AND REQUIREMENTS

Table 4 Test condition, procedure and requirements

TEST	TEST METHOD	PROCEDURE	REQUIREMENTS
Temperature Coefficient of Resistance (T.C.R.)	IEC 60115-1 4.8 MIL-STD-202 Method 304	At +25/-55 °C and +25/+125 °C Formula: $T.C.R = \frac{R_2 - R_1}{R_1(t_2 - t_1)} \times 10^6 \text{ (ppm/°C)}$ Where t ₁ =+25 °C or specified room temperature t ₂ =-55 °C or +125 °C test temperature R ₁ =resistance at reference temperature in ohms R ₂ =resistance at test temperature in ohms	Refer to table 2
Life/Endurance	IEC 60115-1 4.25 MIL-STD-202 Method 108	At 70±2 °C for 1,000 hours, RCWV applied for 1.5 hours on, 0.5 hour off, still-air required	±(1.0%+0.05 Ω) <100 mΩ for Jumper
High Temperature Exposure	MIL-STD-202 Method 108	1,000 hours at 155±3°C unpowered	±(1.0%+0.05 Ω) <100 mΩ for Jumper
Moisture Resistance	MIL-STD-202 Method 106	Each temperature / humidity cycle is defined at 8 hours, 3 cycles / 24 hours for 10d. with 25 °C / 65 °C 95% R.H, without steps 7a & 7b, unpowered Parts mounted on test-boards, without condensation on parts	±(0.5%+0.05 Ω) for 0.5%, 1% tol. ±(1.0%+0.05 Ω) for 5% tol. <100 mΩ for Jumper
Thermal Shock	MIL-STD-202 Method 107	-55 / +125 °C Number of cycles required is 300. Devices mounted Maximum transfer time is 20 seconds. Dwell time is 15 minutes	±(0.5%+0.05 Ω) for 0.5%, 1% tol. ±(1%+0.05 Ω) for 5% tol. <100 mΩ for Jumper
Short Time Overload	IEC60115-1 4.13	2.5 times of rated voltage or maximum overload voltage whichever is less for 5 seconds at room temperature	±(1.0%+0.05 Ω) No visible damage
Bending	IEC 60115-1 4.33	Chips mounted on a 90 mm glass epoxy resin PCB (FR4) Bending: 0201/0402: 5 mm 0603/0805: 3 mm 1206 & above: 2 mm Bending time: 60±5 seconds	±(1.0%+0.05 Ω) <100 mΩ for Jumper No visible damage

TEST	TEST METHOD	PROCEDURE	REQUIREMENTS
Biased Humidity	MIL-STD-202 method 103	1,000 hours; 85°C/85%R.H., 10% of operating power. Measurement at 24±4 hours after test conclusion.	$1\Omega \leq R \leq 1M\Omega: \pm(3\%+0.05\Omega)$ $1M\Omega < R \leq 10M\Omega: \pm(5\%+0.05\Omega)$
Solderability			
- Resistance to Soldering Heat	IEC 60115-1 4.18 MIL-STD-202 Method 215	Condition B, no pre-heat of samples Lead-free solder, 260±5 °C, 10±1 seconds immersion time Procedure 2 for SMD: devices fluxed and cleaned with isopropanol	$\pm(0.5\%+0.05\Omega)$ for 0.5%, 1% tol. $\pm(1.0\%+0.05\Omega)$ for 5% tol. <50 mΩ for Jumper No visible damage
- Wetting	J-STD-002	Electrical test not required Magnification 10X SMD conditions: (a) Method B, aging 4 hours at 155 °C dry heat, lead-free solder bath at 245 °C (b) Method B, dipping at 215 °C for 3 seconds	Well tinned (≥95% covered) No visible damage
FOS	ASTM-B-809-95* * Modified	Sulfur 750 hours, 105 °C. unpowered	$\pm(4.0\%+0.05\Omega)$

REVISION HISTORY

REVISION	DATE	CHANGE NOTIFICATION	DESCRIPTION
Version 5	Jun. 21, 2016	-	- Update test and requirement
Version 4	Dec. 24, 2015	-	- Update Dielectric Withstanding Voltage& Resistance value
Version 3	Apr. 01, 2015	-	- Modified test and requirements
Version 2	Nov. 20, 2014	-	- Tests and requirement update
Version 1	Sep. 27, 2013	-	- Size 0201/1210/1218/2010/2512 extend
Version 0	Jan 07, 2011	-	- First issue of this specification

“Yageo reserves all the rights for revising the content of this datasheet without further notification, as long as the products are unchanged. Any product change will be announced by PCN.”