

DATA SHEET

**CURRENT SENSOR - LOW TCR
AUTOMOTIVE GRADE**

PA series

5%, 1%

sizes 2512

RoHS compliant & Halogen free



SCOPE

This specification describes PA series current sensor - low TCR with lead-free terminations made by metal substrate.

APPLICATIONS

- Consumer goods
- Computer
- Telecom / Datacom
- Industrial / Power supply
- Alternative Energy
- Car electronics

FEATURES

- Comply with AEC-Q200 standard
- Halogen-free Epoxy
- RoHS compliant
- Reduce environmentally hazardous wastes
- High component and equipment reliability
- Non-forbidden materials used in products/production
- Low resistances applied to current sensing

ORDERING INFORMATION - GLOBAL PART NUMBER

Global part numbers are identified by the series, size, tolerance, packing type, temperature coefficient, taping reel and resistance value.

GLOBAL PART NUMBER

PA XXXX X X X XX XXXX L
(1) (2) (3) (4) (5) (6) (7)

(1) SIZE

2512

(2) TOLERANCE

F = ±1%
J = ±5%

(3) PACKAGING TYPE

K = Embossed taping reel

(4) TEMPERATURE COEFFICIENT OF RESISTANCE

F = ±100 ppm/°C
H = ±275 ppm/°C

(5) TAPING REEL

07 / 7W / 7T = 7 inch dia. Reel and specific rated power
Detailed power rating are shown in the Table 2.

(6) RESISTANCE VALUE

1 mΩ to 5 mΩ

(7) DEFAULT CODE

Letter L is the system default code for ordering only. (Note)

Resistance code rule	Example
0RXXXX <small>(0.1 to 5 mΩ)</small>	0R001 = 1 mΩ

ORDERING EXAMPLE

The ordering code of a PA2512 1W chip resistor, TC100, value 0.003Ω with ±1% tolerance, supplied in 7-inch tape reel is: PA2512FKF070R003L

NOTE

1. All our RChip products are RoHS compliant. "LFP" of the internal 2D reel label mentions "Lead-Free Process"

MARKING

PA2512

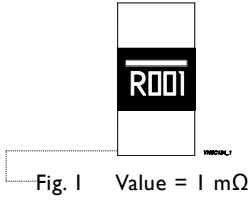

4 digits
The “R” is used as a decimal point; the other 3 digits are significant
PA2512: 1mΩ to 4 mΩ

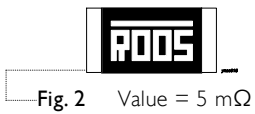

4 digits
The “R” is used as a decimal point; the other 3 digits are significant
PA2512: 5 mΩ

CONSTRUCTION

The resistors are constructed using outstanding TCR level material, which makes Yageo PA resistors excellent for current sensing application in battery charger circuit & DC-DC converter.

The composition of the resistive material is adjusted to give the approximate required resistance and is covered with a protective coating. Marking is printed on the top side of the resistor.

Finally, the three external terminations (Cu / Ni / matte Tin) are added, as shown in Fig. 4.

Outlines

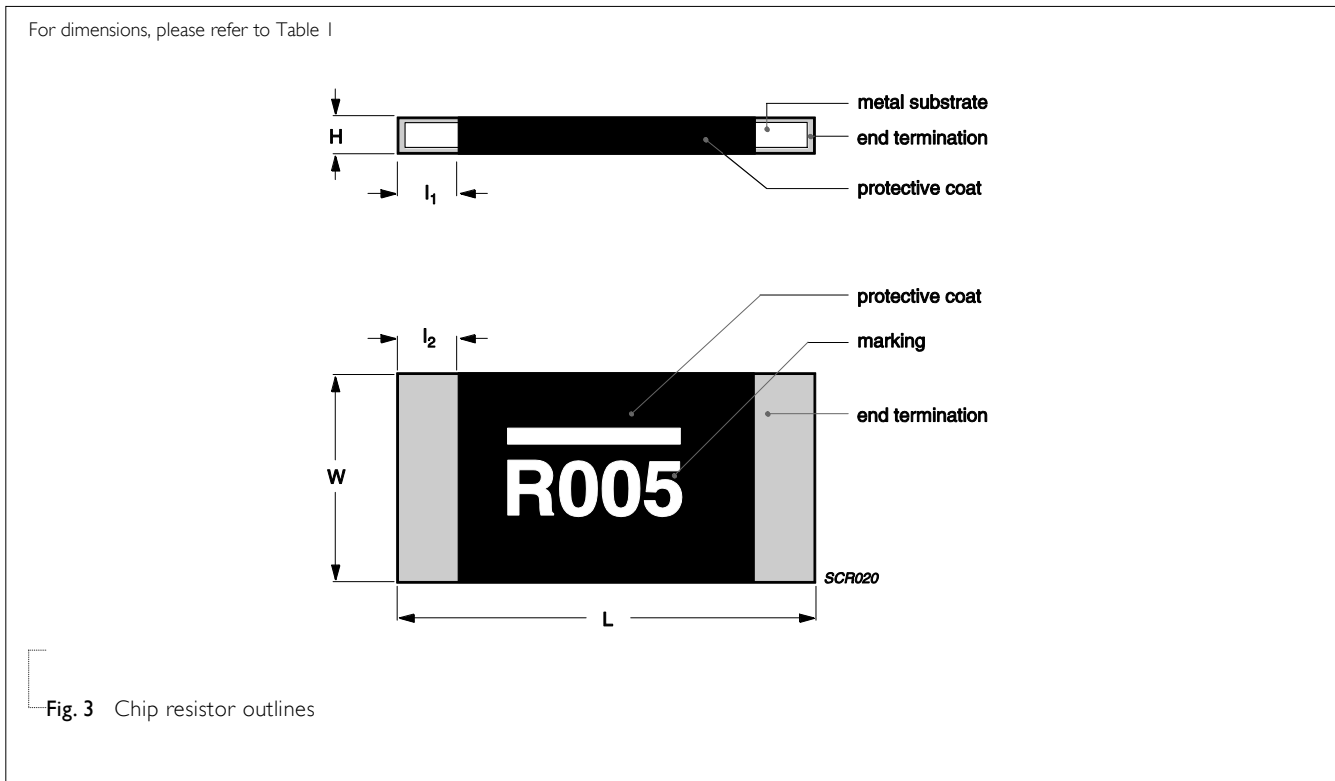

DIMENSION

Table 1 For outlines, please refer to Fig. 4

TYPE	RESISTANCE RANGE	POWER RATING	L (mm)	W (mm)	H (mm)	l ₁ (mm)	l ₂ (mm)
PA2512	$1\text{m}\Omega \leq R \leq 4\text{m}\Omega$	1W	6.35 ± 0.25	3.18 ± 0.25	0.63 ± 0.25	2.21 ± 0.25	2.21 ± 0.25
	$5\text{m}\Omega$	2W 3W	6.35 ± 0.25	3.18 ± 0.25	0.63 ± 0.25	1.19 ± 0.25	1.19 ± 0.25

Note:

1. For relevant physical dimensions, please refer to construction outlines.
2. Please contact with sales offices, distributors and representatives in your region before ordering.

ELECTRICAL CHARACTERISTICS

Table 2

SERIES	SIZE	POWER RATING				TOLERANCE	RESISTANCE RANGE	TEMPERATURE COEFFICIENT OF RESISTANCE	
		07	7W	7T	47				
PA	2512	1W	2W	3W	---	±1% ±5%	1 mΩ ≤ R ≤ 5 mΩ	1 mΩ	±275 ppm/°C
								2 mΩ < R ≤ 5 mΩ	±100 ppm/°C

Note: Please contact with sales offices, distributors and representatives in your region before ordering.

FUNCTIONAL DESCRIPTION

OPERATING TEMPERATURE RANGE

PA2512 Range: -55°C to +170°C

POWER RATING

Standard rated power at 70°C:

For detail power value, please refer to Table 2.

RATED VOLTAGE

The DC or AC (rms) continuous working voltage corresponding to the rated power is determined by the following formula:

$$V = \sqrt{P \times R}$$

Where

V = Continuous rated DC or AC (rms) working voltage (V)

P = Rated power (W)

R = Resistance value (Ω)

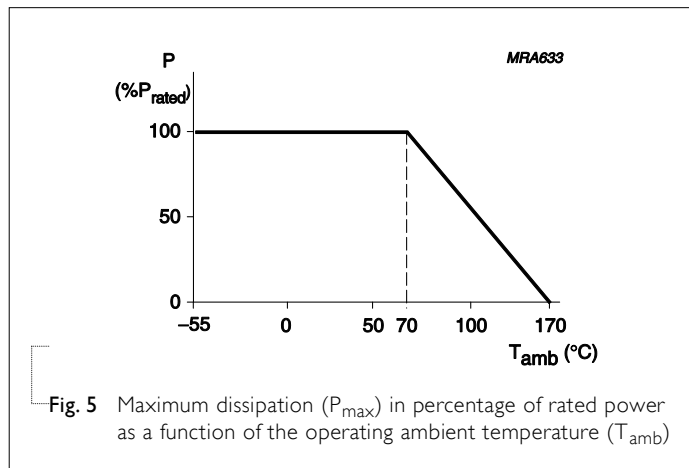

Fig. 5 Maximum dissipation (P_{max}) in percentage of rated power as a function of the operating ambient temperature (T_{amb})

PACKING STYLE AND PACKAGING QUANTITY

Table 3 Packing style and packaging quantity

PACKING STYLE	REEL DIMENSION	PA2512
Embossed taping reel (K)	7" (178 mm)	4,000

EMBOSSED TAPE

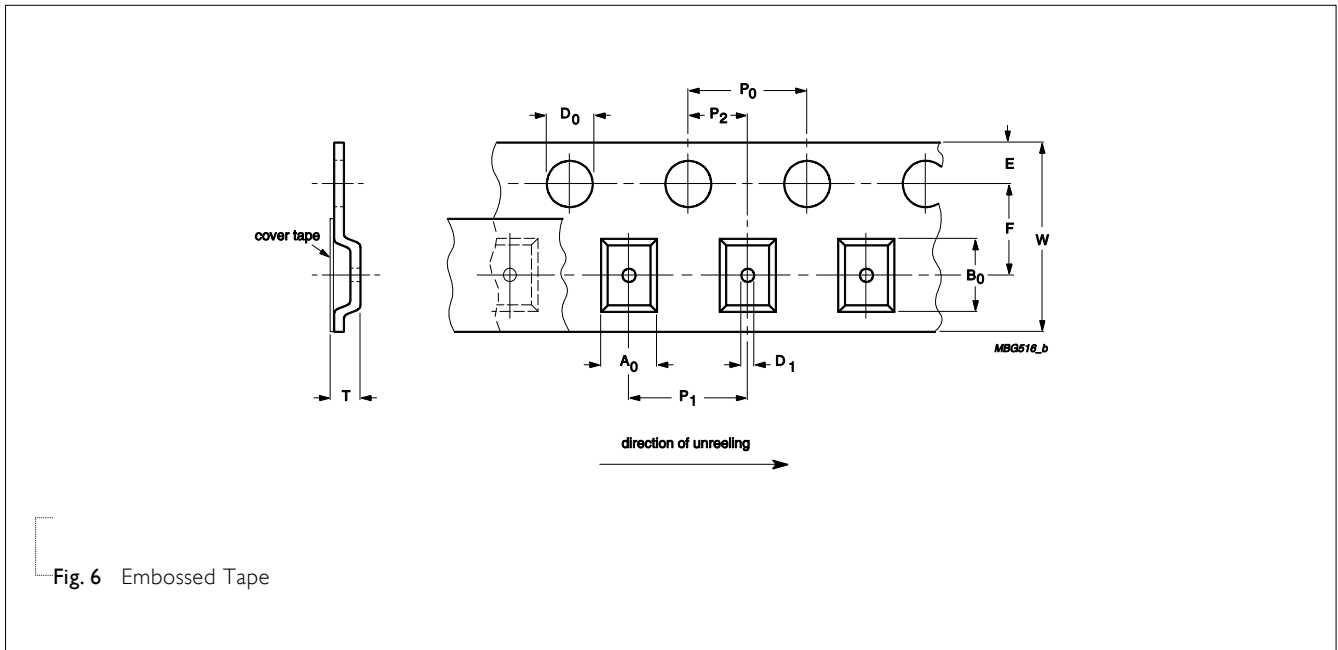

Fig. 6 Embossed Tape

Table 4 Dimensions of embossed tape for relevant chip resistors size

SIZE	SYMBOL										Unit: mm
	A ₀	B ₀	W	E	F	P ₀	P ₁	P ₂	ØD ₀	ØD ₁	T
PA2512	3.40±0.15	6.70±0.15	12.00±0.30	1.75±0.10	5.50±0.10	4.00±0.10	4.00±0.10	2.00±0.10	1.55±0.05	1.50±0.10	0.80±0.15

REEL SPECIFICATION

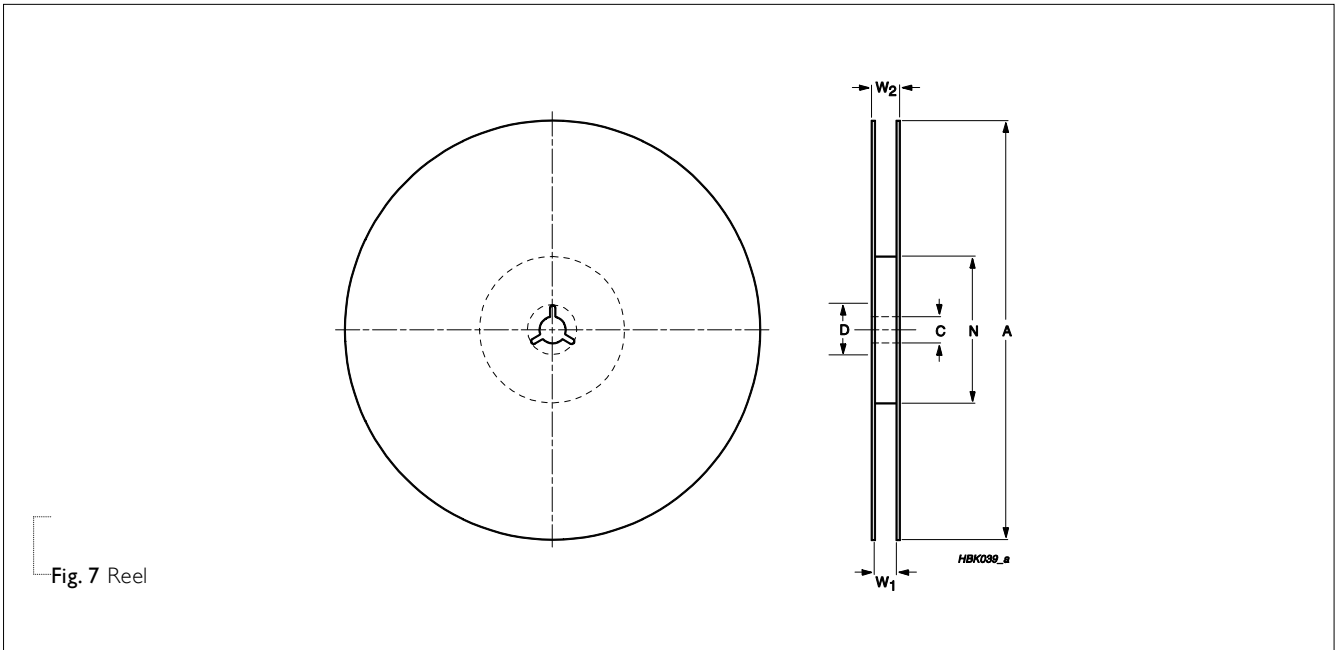
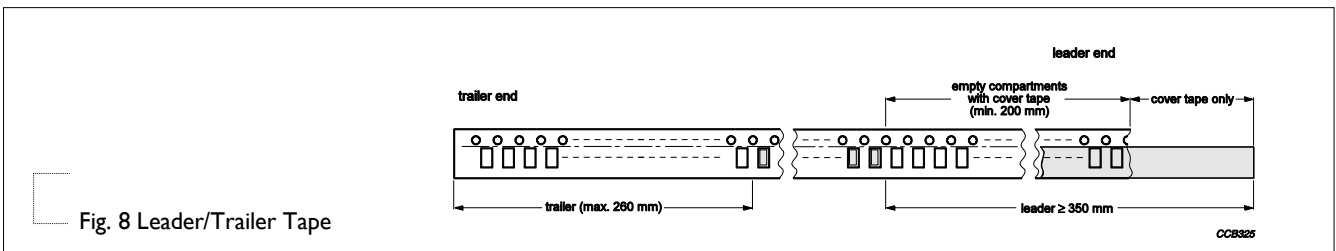

Table 5 Dimensions of reel specification for relevant chip resistors size

SIZE	QUANTITY PER REEL	REEL SIZE		SYMBOL					Unit: mm	
		8 mm TAPE WIDE	12 mm TAPE WIDE	A	N	C	D	W ₁	W ₂ MAX.	
PA2512	4000	--	7" (Ø178 mm)	178.0±1.0	60.0+1/-0	13.50±0.5	21.0±0.8	13.6±0.5	16.5±0.5	

LEADER/TRAILER TAPE SPECIFICATION



FOOTPRINT AND SOLDERING PROFILES

For recommended soldering profiles, please refer to data sheet “Chip resistors mounting”.

FOOTPRINT

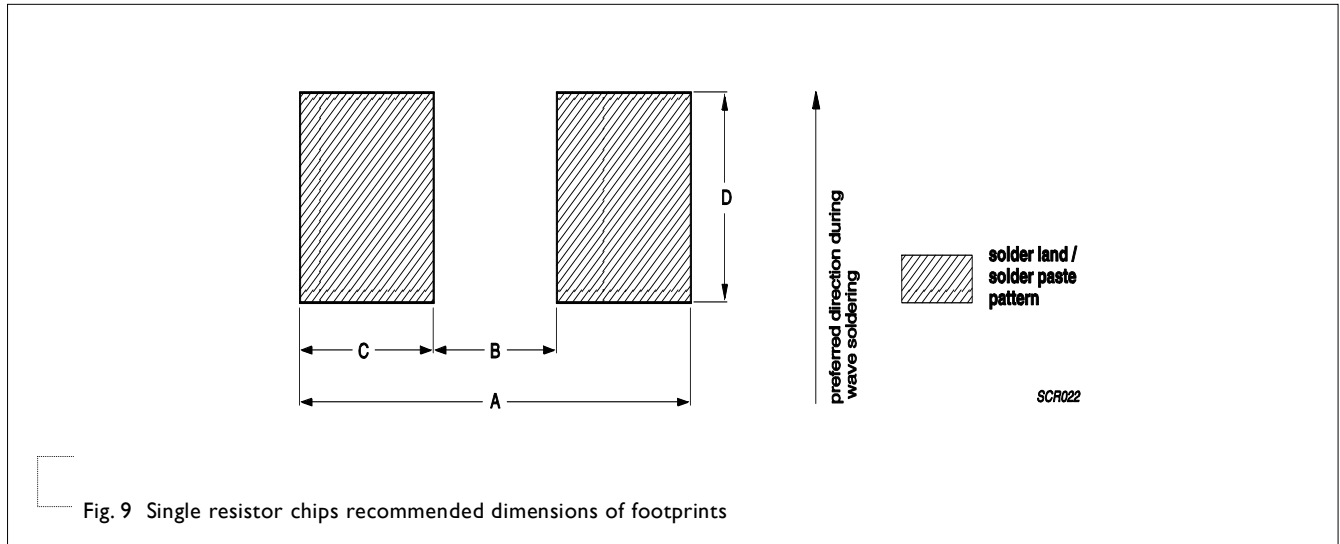

Table 6 Footprint dimensions

SIZE	RESISTANCE RANGE	POWER RATING	Unit: mm			
			A	B	C	D
PA2512	$1\text{m}\Omega \leq R \leq 4\text{m}\Omega$	1W, 2W, 3W	7.37	1.27	3.05	3.68
	5mΩ		7.40	3.18	2.11	3.68

TESTS AND REQUIREMENTS

Table 8 Test condition, procedure and requirements

TEST	TEST METHOD	PROCEDURE	REQUIREMENT
Short time overload	IEC60115-1 4.13	5 times of rated power for 5 seconds at room temperature	$\pm(0.5\%+0.0005\Omega)$ No visible damage
High Temperature Exposure/ Endurance at Upper Category Temperature	MIL-STD-202G-Method 108A	1,000 hours at maximum operating temperature depending on specification, unpowered No direct impingement of forced air to the parts Tolerances: $170\pm 3^{\circ}\text{C}$	$\pm(1.0\%+0.0005\Omega)$
Temperature Cycling	JESD22-A104C	1,000 cycles, $-55/+125^{\circ}\text{C}$ for 1 cycle per hour	$\pm(0.5\%+0.0005\Omega)$
Moisture Resistance	MIL-STD-202G-Method 106F	Each temperature / humidity cycle is defined at 8 hours (method 106F), 3 cycles / 24 hours for 10d with 25°C / 65°C 95% R.H, without steps 7a & 7b, unpowered	$\pm(0.5\%+0.0005\Omega)$
Biased Humidity	MIL-STD-202 Method 103	1,000 hours; 85°C / 85% RH 10% of operating power	$\pm(0.5\%+0.0005\Omega)$
Operational Life/ Endurance	MIL-STD-202G-Method 108A IEC 60115-1 4.25.1	1,000 hours at $125\pm 3^{\circ}\text{C}$, de-rated voltage applied for 1.5 hours on, 0.5 hour off, still-air required 1,000 hours at $70\pm 2^{\circ}\text{C}$ applied RCWV 1.5 hours on, 0.5 hour off, still air required	$\pm(1.0\%+0.0005\Omega)$ $\pm(1.0\%+0.0005\Omega)$
Resistance to Solvents	MIL-STD-202 Method 215	Immerse in isopropyl alcohol for 5 min with ultrasonic at room temperature	$\pm(1.0\%+0.0005\Omega)$
Mechanical Shock	MIL-STD-202 Method 213	Three shocks in each direction shall be applied along the three mutually perpendicular axes of the test specimen. Peak value: 1,500 g's Duration: 0.5 ms Velocity change: 15.4 ft/s Waveform: Half sine	$\pm(0.5\%+0.0005\Omega)$
Vibration	MIL-STD-202 Method 204	5 g's for 20 min., 12 cycles each of 3 orientations Test from 10-2000 Hz.	$\pm(0.5\%+0.0005\Omega)$
Resistance to Soldering Heat	MIL-STD-202G-method 210F	Condition B, no pre-heat of samples Leadfree solder, 260°C , 10 seconds immersion time Procedure 2 for SMD: devices fluxed and cleaned with isopropanol	$\pm(0.5\%+0.0005\Omega)$ No visible damage
Thermal Shock	MIL-STD-202 Method 107	$-55/+150^{\circ}\text{C}$, Number of cycles is 300. Maximum transfer time is 20 seconds. Dwell time is 15 minutes. Air -Air	$\pm(0.5\%+0.0005\Omega)$ No visible damage

TEST	TEST METHOD	PROCEDURE	REQUIREMENT
Electrostatic Discharge	AEC-Q200-002	Human Body Model, 1 pos + 1 neg. Discharges 2512=2KV	$\pm(1.0\%+0.0005\Omega)$ No visible damage
Solderability - Wetting	J-STD-002	(a) Method B, aging 4 hours at 155°C dry heat, dipping at 235±3°C for 5±0.5 seconds. (b) Method B, steam aging 8 hours, dipping at 215±3°C for 5±0.5 seconds. (c) Method D, steam aging 8 hours, dipping at 260±3 °C for 7±0.5 seconds.	Well tinned (>95% covered) No visible damage
Flammability	UL94	Try to inflame a specimen by a needle flame	No ignition of specimen; V-0
Board Flex / Bending	AEC-Q200-005	Chips mounted on a 90mm glass epoxy resin PCB (FR4), Bending for 2512=2 mm Holding time: Min.60 seconds	$\pm(1.0\%+0.0005\Omega)$
Terminal Strength (SMD)	AEC-Q200-006	Applied a 17.7N (1.8Kg) for 60±1 seconds.	$\pm(1.0\%+0.0005\Omega)$ No visible damage
Flame Retardance	AEC-Q200-001	Apply voltage from 9V to 32V to increase the surface temp to 350°C	No flame, no explosion
Temperature Coefficient of Resistance (T.C.R.)	IEC 60115-1 4.8	At +25/-55°C and +25/+125°C Formula: $T.C.R = \frac{R_2 - R_1}{R1(t_2 - t_1)} \times 10^6 (\text{ppm}/^\circ\text{C})$ Where t1=+25°C or specified room temperature t2=-55°C or +125°C test temperature R1=resistance at reference temperature in ohms R2=resistance at test temperature in ohms	Refer to table 2
Flower-of-Sulfur (FOS)	Modified ASTM B809-95	Sulfur 105°C, 750 hours, unpowered.	$\pm(1.0\%+0.0005\Omega)$

REVISION HISTORY

REVISION	DATE	CHANGE NOTIFICATION	DESCRIPTION
Version 0	Aug. 22, 2014	-	- New datasheet for automotive grade current sensor -PA series.

“Yageo reserves all the rights for revising the content of this datasheet without further notification, as long as the products itself are unchanged. Any product change will be announced by PCN.”