

SPECIFICATIONS

CONTACT RATING: Dependent upon contact material

MECHANICAL LIFE: 30,000 make-and-break cycles.

CONTACT RESISTANCE: 10 mΩ max. initial @ 2-4VDC
100mA for both silver and gold plated contacts.

INSULATION RESISTANCE: 1,000 MΩ min.

DIELECTRIC STRENGTH: 1,000 Vrms min. @ sea level.

OPERATING TEMPERATURE: -40°C to 85°C.

MATERIALS

CASE: Diallyl phthalate (DAP) (UL94v-0).

HOUSING: Stainless Steel.

ACTUATOR: Nylon, black std.

CONTACT/TERMINALS: Copper alloy, with silver or gold plated.

TERMINAL SEAL: Epoxy.



HOW TO ORDER

MODEL NO. ACTUATOR ACTUATOR COLOR MOUNTING EARS TERMINATIONS TERMINAL PLATING SEAL RoHS SOLDERING

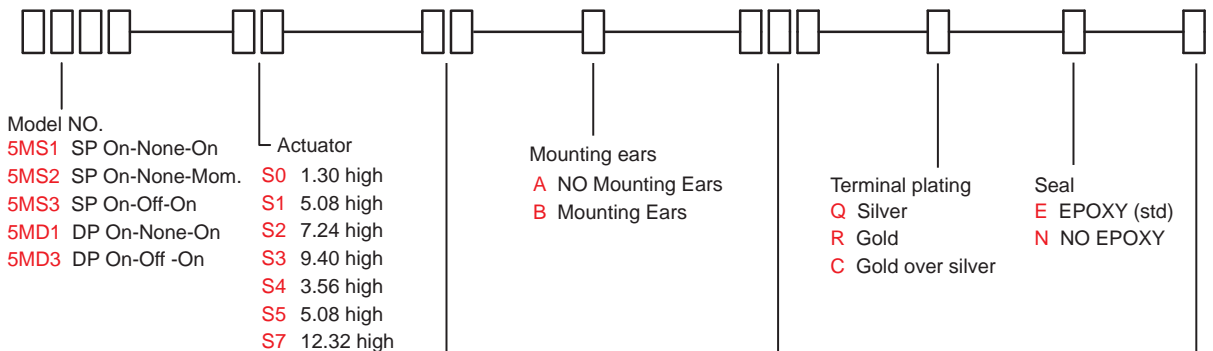

Actuator color

ITEM NO	COLOR
01	White
02	Black (Std)
03	Red
04	Orange
05	Yellow
06	Green
07	Blue
08	Brown
09	Gray

* Besides standard color, other colors need to check stocks available.

Terminations

- M1** Solder Lug
- M2** PC thru-hole
- M3** Quick Connect
- M51** 18.70 high, wire wrap
- M52** 24.20 high, wire wrap
- M53** 10.55 high, wire wrap
- M54** 26.97 high, wire wrap
- M6** Right angle, PC thru-hole
- M7** Vertical right angle, PC thru-hole
- VS2** V-bracket

RoHS soldering
S RoHS & Lead Free



5M Series

Slide Switches

SWITCH FUNCTION

NO. POLES	UL/CSA MODEL NO.	MODEL NO.	SWITCH FUNCTION			CONNECTED TERMINALS / SCHEMATIC		
			POS.1	POS.2	POS.3	POS.1	POS.2	POS.3
SP	Q1511	5MS1	ON	NONE	ON	2-1	N/A	2-3
	Q1512	5MS2	ON	NONE	MOM		OPEN	
	Q1513	5MS3	ON	OFF	ON			
DP	Q1521	5MD1	ON	NONE	ON	2-1,5-4	N/A	2-3,5-6
	Q1523	5MD3	ON	OFF	ON		OPEN	

MOM=MENTORY

POLE OPTIONS

5M Slide Switches

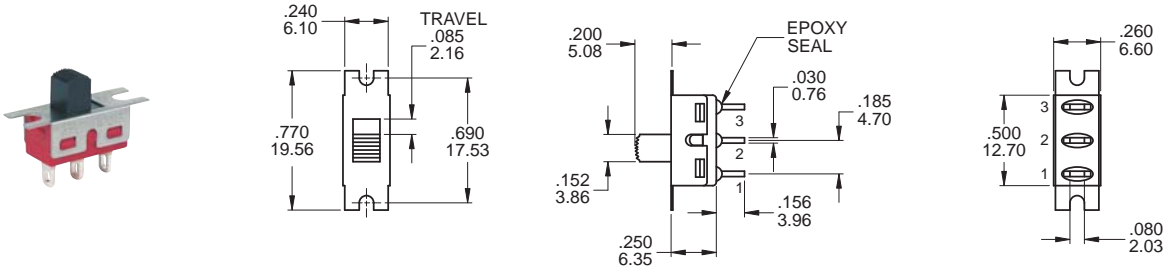

SPDT

Part No. Shown : 5MS1S102BM1QES

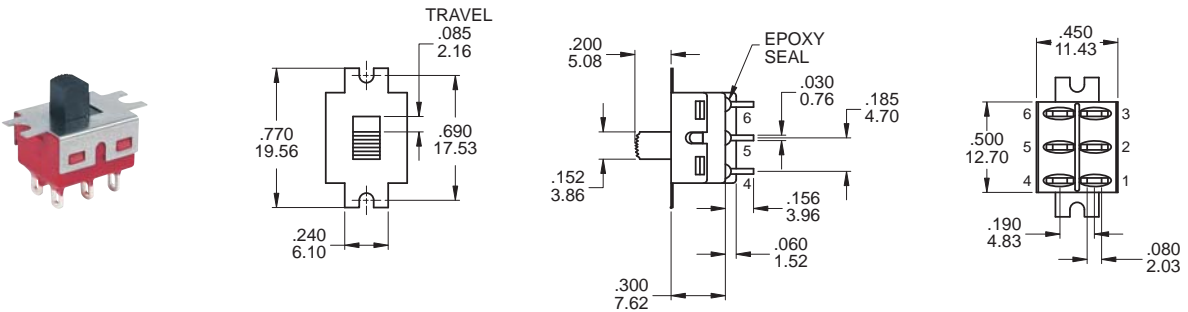

DPDT

Part No. Shown : 5MD1S102BM1QES

ACTUATOR OPTIONS

S1 STD

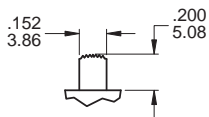

S2

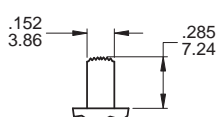

S0 Only for S1,S2,D1,D3 model type

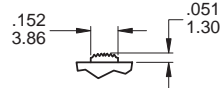

FRONT

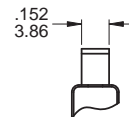

▲ S5 Only DPDT

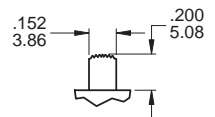

S3

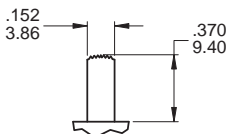

S4

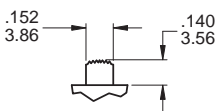

S7

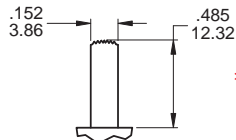

For S0,S1,S2,S3,S4 actuator

* Subtract .014(0.36) from Actuator height for M6, M7 P.C. mounting option.

FRONT

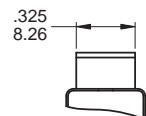

TERMINATION OPTIONS

M1 Solder lug

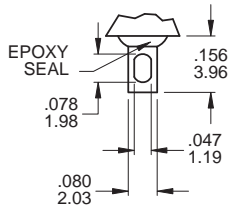

.030(0.76) THK.

M2 PC Thru-hole

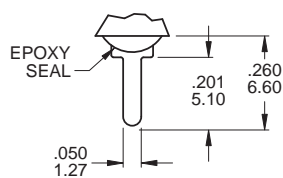

.030(0.76) THK.

M3 Quick connect

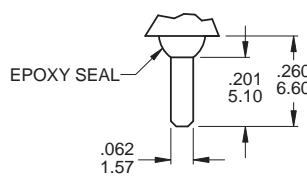

THK .030(0.76)

M5 Wire Wrap

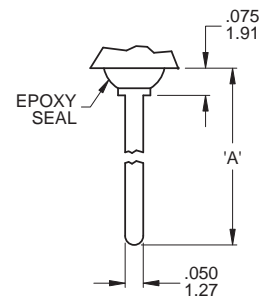

THK .030(0.76)

OTHER TERMINATION OPTIONS

M6 Right angle P.C. Mount

M7 Right angle P.C. Mount

VS2 Vertical bracket P.C. Mount

OPTION CODE	DIM. 'A'
M51	.736 (18.70)
M52	.953 (24.20)
M53	.415 (10.55)
M54	1.062 (26.97)

M6

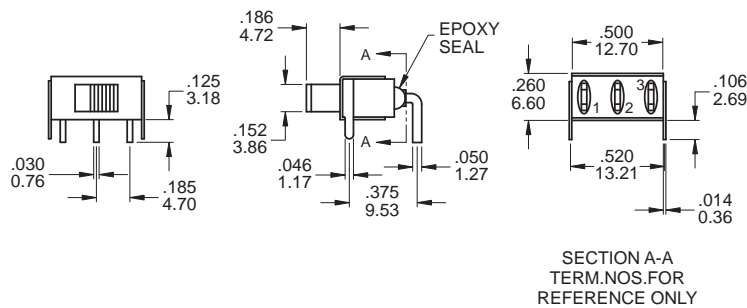

P.C. MOUNTING

SECTION A-A
TERM.NOS.FOR
REFERENCE ONLY

SPDT

Part No. Shown : 5MS1S102AM6QES

M6

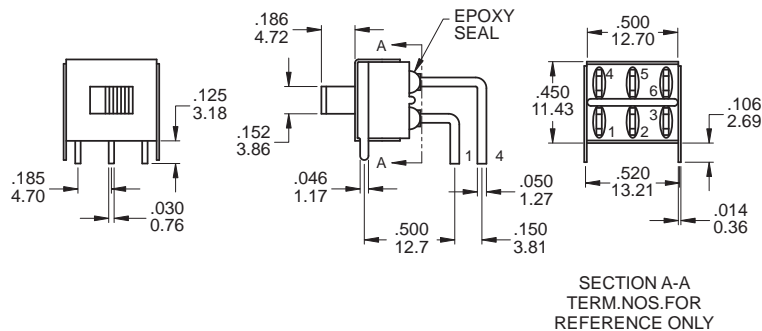

P.C. MOUNTING

SECTION A-A
TERM.NOS.FOR
REFERENCE ONLY

DPDT

Part No. Shown : 5MD1S102AM6QES



5M
Slide Switches

5M Series

Slide Switches

M7

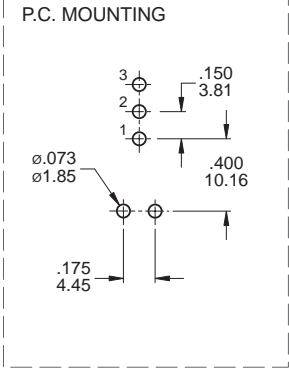
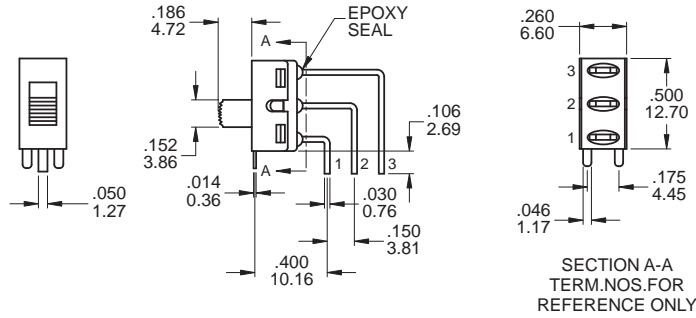

SPDT

Part No. Shown : 5MS1S102AM7QES

M7

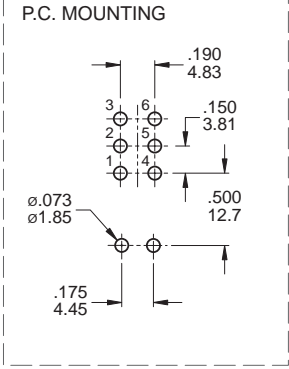
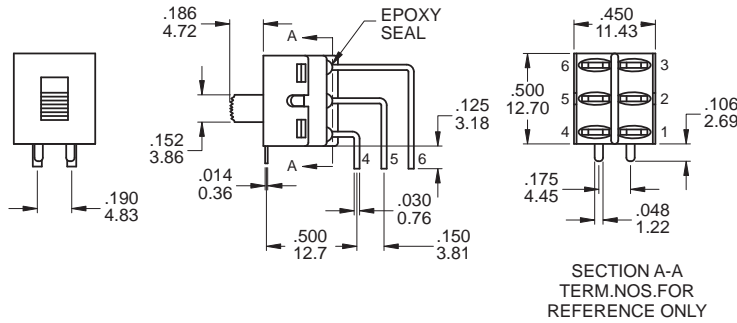
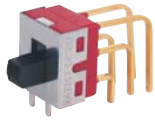

DPDT

Part No. Shown : 5MD1S102AM7RES

VS2

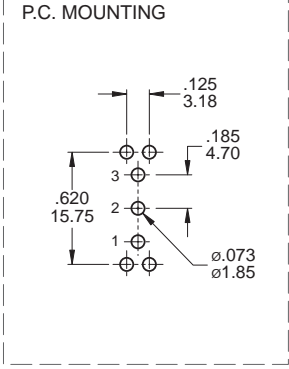
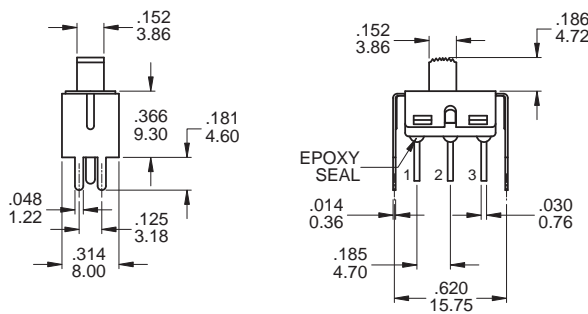
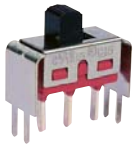

SPDT

Part No. Shown : 5MS1S102AVS2QES

VS2

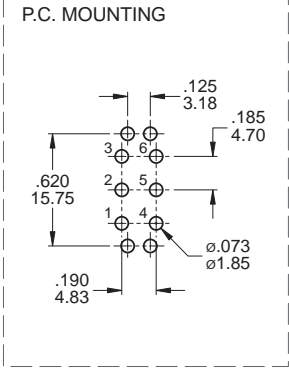
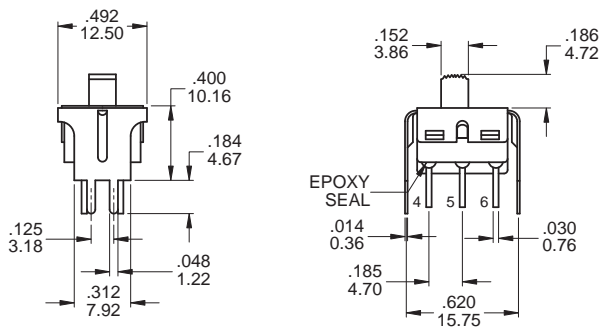
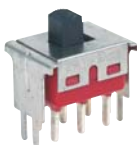

DPDT

Part No. Shown : 5MD1S102AVS2QES

MOUNTING EARS / PANEL MOUNT

MOUNTING EARS

"A" WITHOUT MOUNTING EARS

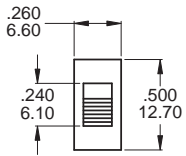

"B" WITH MOUNTING EARS

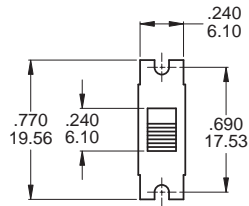

THREE POSITIONS ONLY

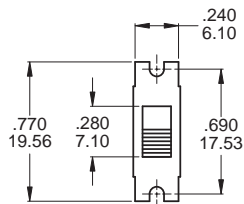
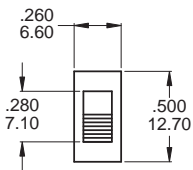

PANEL MOUNTING

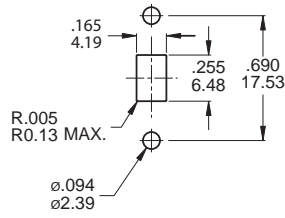

For S0,S1,S2,S3,S4 actuator

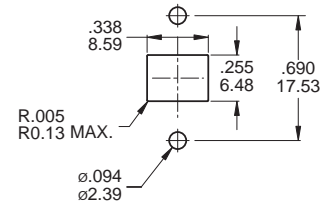

For S5 actuator only

THREE POSITIONS ONLY

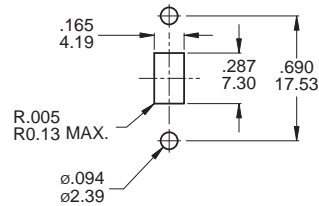

For S0,S1,S2,S3,S4 actuator

CONTACT MATERIAL OPTIONS

	CONTACT PLATING	TERMINAL PLATING	RATINGS
Q	Silver	Q = Silver	5 Amps with resistant load @ 120VAC or 28VDC 2 Amps with resistant load @ 250VAC
C	Gold over Silver	C = Gold over silver	
R	Gold	R = Gold	0.4 Volt - Amps (VA) max. @ 20V max. (AC or DC)

SOLDERING PROCESSES

MANUAL SOLDERING : Use soldering iron of 30 watts, controlled at 350°C approximately 5 seconds while applying solder.

WAVE SOLDERING : Recommended Soldering Temperature : 270 ± 5°C

Duration of Solder Immersion : Max 5sec. (PCB is 1.6mm in thickness)

