

BSS138 MOSFET(N-Channel)

V(BR)DSS	RDS(ON)MAX	ID
50V	3.5Ω@10V	0.22A
	6Ω@4.5V	

SOT-23

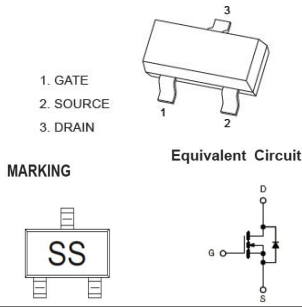

SOT-23 贴片塑封场效应管
SOT-23 Plastic-Encapsulate MOSFET

特征 Features

- TrenchFET Power MOSFET
- Load Switch for Portable Devices.
- DC/DC Converter.

机械数据 Mechanical Data

- 封装: SOT-23 封装 SOT-23 Small Outline Plastic Package.
- 环氧树脂 UL 易燃等级 Epoxy UL: 94V-0.
- 安装位置: 任意 Mounting Position: Any.

极限值和温度特性(TA = 25℃ 除非另有规定)

Maximum Ratings & Thermal Characteristics (Ratings at 25℃ ambient temperature unless otherwise specified.)

参数 Parameters	符号 Symbol	数值 Value	单位 Unit
Drain-Source Voltage	V _{DS}	50	V
Gate-Source Voltage	V _{GS}	±20	V
Continuous Drain Current	I _D	0.22	A
Power Dissipation	P _D	350	mW
Junction Temperature	T _j	150	℃
Storage Temperature	T _{stg}	-50-+150	℃
Thermal Resistance From Junction to Ambient	R _{θJA}	357	℃/W

电特性 (TA = 25℃ 除非另有规定)

Electrical Characteristics (Ratings at 25℃ ambient temperature unless otherwise specified.)

参数 Parameter	符号 Symbols	测试条件 Test Condition	界限 Limits			单位 Unit
			Min	Typ	Max	
Static						
Drain-Source Breakdown Voltage	V(BR)DSS	V _{GS} =0V, I _D =250uA	50			V
Gate-Threshold voltage(note1)	V _{GS(th)}	V _{DS} =V _{GS} , I _D =1mA	0.8		1.5	V
Gate-body Leakage	I _{GSS}	V _{DS} =0V, V _{GS} =±20V			±100	nA
Zero Gate Voltage Drain current	I _{DSS}	V _{DS} =50V, V _{GS} =0V			0.5	uA
		V _{DS} =30V, V _{GS} =0V			0.1	
Drain-Source On-Resistance (note1)	R _{DS(ON)}	V _{GS} =10V, I _D =0.22A			3.5	Ω
		V _{GS} =4.5V, I _C =0.22A			6	
Forward trans conductance (note1)	g _{fs}	V _{DS} =10V, I _D =0.22A	0.12			S
Diode forward voltage(note1)	V _{SD}	I _S =0.44A, V _{GS} =0V			1.4	V
Dynamic(note2)						
Input capacitance	C _{iss}	V _{DS} =25V, V _{GS} =0V, f=1MHz		27		pF
Output capacitance	C _{oss}			13		
Reverse Transfer capacitance	C _{rss}			6		
Switching(note1,2)						
Turn-on Time	t _{d(on)}	V _{DD} =30V, R _{GEN} =6Ω, V _{DS} =10V, I _D ≈0.29A,			5	ns
Rise time	t _r				18	
Turn-off Time	t _{d(off)}				36	
Fall time	t _f				14	

Notes: a. Pulse Test: Pulse Width ≤300us, Duty Cycle≤2%.
b. These parameters have no way to verify.

Typical characteristics

Output Characteristics

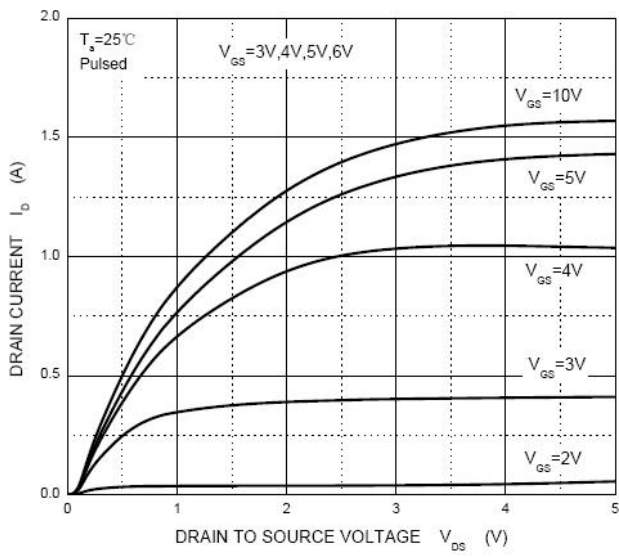

Transfer Characteristics

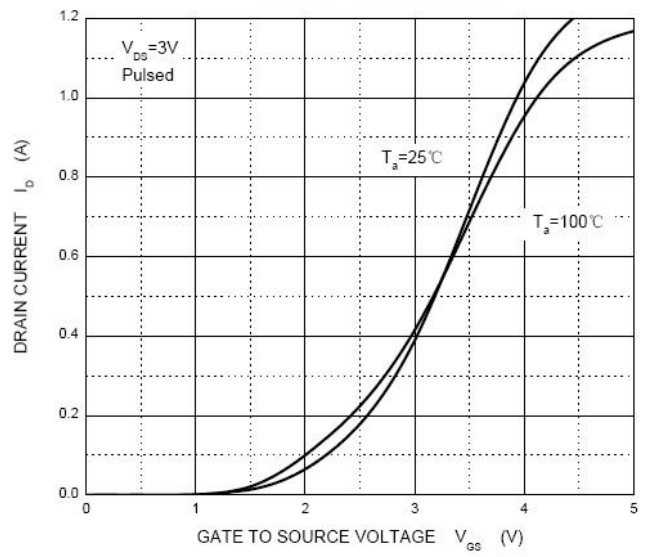

$R_{DS(ON)}$ — I_D

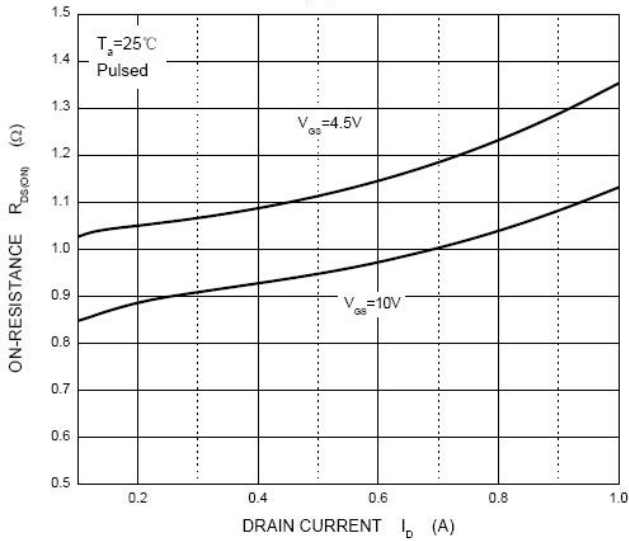

$R_{DS(ON)}$ — V_{GS}

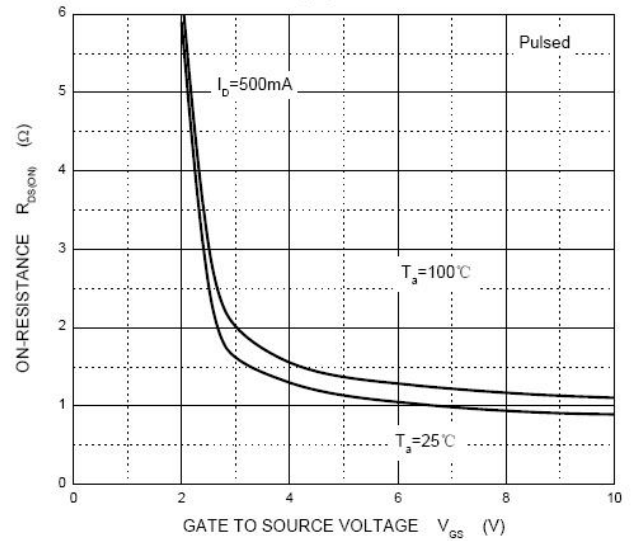

I_S — V_{SD}

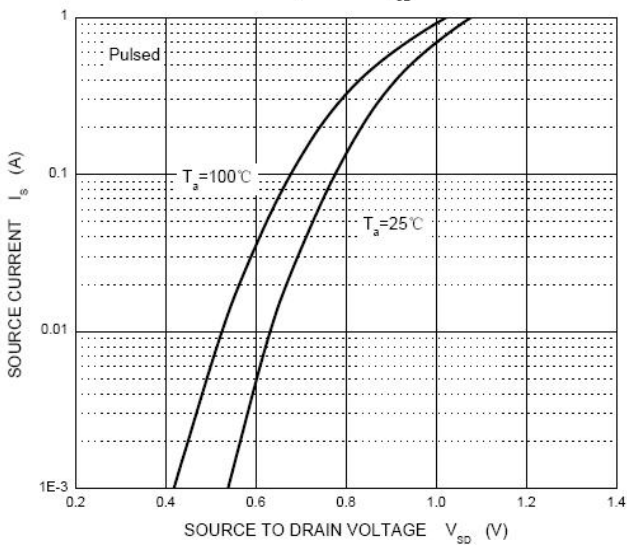

Threshold Voltage

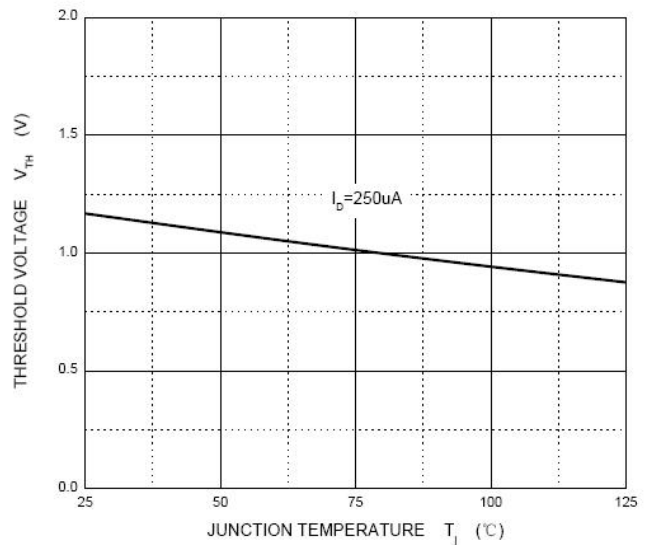

SOT-23 PACKAGE OUTLINE Plastic surface mounted package

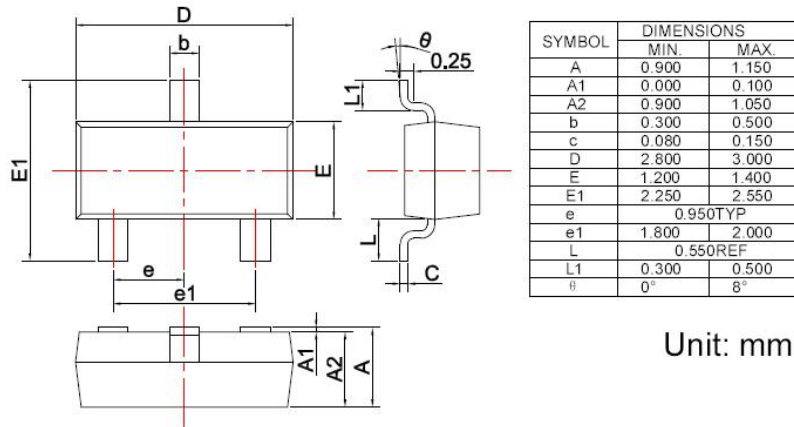

焊盘设计参考 Precautions: PCB Design

Recommended land dimensions for SOT-23 diode. Electrode patterns for PCBs

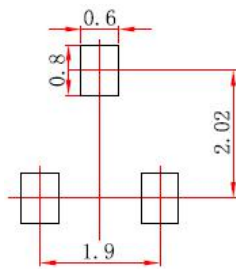

- Note:
1. Controlling dimension: In millimeters.
 2. General tolerance: ± 0.05mm.
 3. The pad layout is for reference purposes only.