

## 150 mA, Tiny CMOS LDO With Shutdown

### Features:

- Space-saving 5-Pin SC-70 and SOT-23 Packages
- Extremely Low Operating Current for Longer Battery Life: 53  $\mu$ A (typ.)
- Very Low Dropout Voltage
- Rated 150 mA Output Current
- Requires Only 1  $\mu$ F Ceramic Output Capacitance
- High Output Voltage Accuracy:  $\pm 0.5\%$  (typical)
- 10  $\mu$ s (typ.) Wake-Up Time from  $\overline{\text{SHDN}}$
- Power-Saving Shutdown Mode: 0.05  $\mu$ A (typ.)
- Overcurrent and Overtemperature Protection
- Pin-Compatible Upgrade for Bipolar Regulators

### Applications:

- Cellular/GSM/PHS Phones
- Battery-Operated Systems
- Portable Computers
- Medical Instruments
- Electronic Games
- Pagers

### General Description:

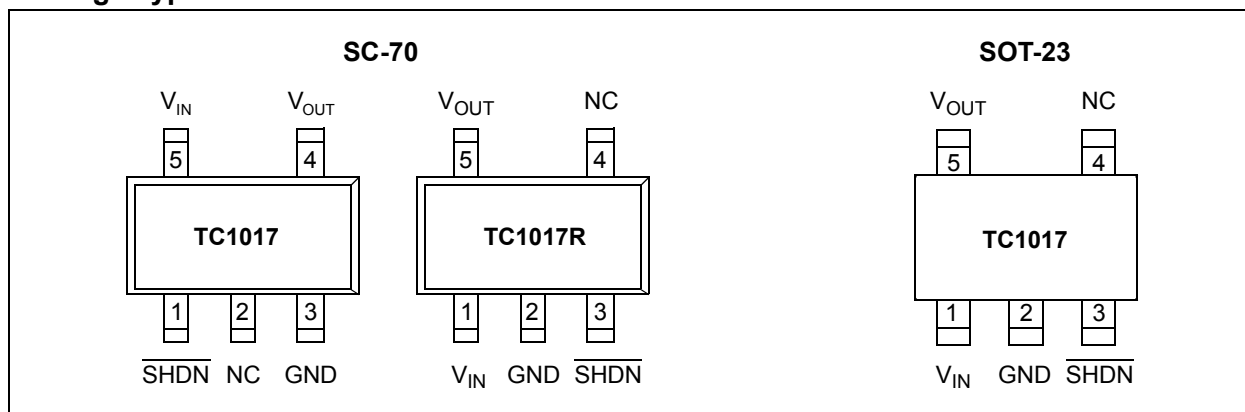
The TC1017 is a high-accuracy (typically  $\pm 0.5\%$ ) CMOS upgrade for bipolar Low Dropout regulators (LDOs). It is offered in a SC-70 or SOT-23 package. The SC-70 package represents a 50% footprint reduction versus the popular SOT-23 package and is offered in two pinouts to make board layout easier.

Developed specifically for battery-powered systems, the TC1017's CMOS construction consumes only 53  $\mu$ A typical supply current over the entire 150 mA operating load range. This can be as much as 60 times less than the quiescent operating current consumed by bipolar LDOs.

The TC1017 is designed to be stable, over the entire input voltage and output current range, with low-value (1  $\mu$ F) ceramic or tantalum capacitors. This helps to reduce board space and save cost. Additional integrated features, such as shutdown, overcurrent and overtemperature protection, further reduce the board space and cost of the entire voltage-regulating application.

Key performance parameters for the TC1017 include low dropout voltage (285 mV typical at 150 mA output current), low supply current while shutdown (0.05  $\mu$ A typical) and fast stable response to sudden input voltage and load changes.

### Package Types



# TC1017

## 1.0 ELECTRICAL CHARACTERISTICS

### Absolute Maximum Ratings †

Input Voltage .....6.5V  
 Power Dissipation ..... Internally Limited (**Note 7**)  
 Maximum Voltage On Any Pin ..... $V_{IN} + 0.3V$  to  $-0.3V$

† **Notice:** Stresses above those listed under “Maximum Ratings” may cause permanent damage to the device. This is a stress rating only and functional operation of the device at those or any other conditions above those indicated in the operation listings of this specification is not implied. Exposure to maximum rating conditions for extended periods may affect device reliability.

## PIN FUNCTION TABLE

Name	Function
$\overline{\text{SHDN}}$	Shutdown control input.
NC	No connect
GND	Ground terminal
$V_{OUT}$	Regulated voltage output
$V_{IN}$	Unregulated supply input

## ELECTRICAL CHARACTERISTICS

<b>Electrical Specifications:</b> Unless otherwise noted, $V_{IN} = V_R + 1V$ , $I_L = 100 \mu A$ , $C_L = 1.0 \mu F$ , $\overline{\text{SHDN}} > V_{IH}$ , $T_A = +25^\circ C$ <b>Boldface</b> type specifications apply for junction temperatures of $-40^\circ C$ to $+125^\circ C$ .						
Parameter	Sym.	Min.	Typ.	Max.	Units	Test Conditions
Input Operating Voltage	$V_{IN}$	<b>2.7</b>	—	<b>6.0</b>	V	<b>Note 1</b>
Maximum Output Current	$I_{OUTMAX}$	<b>100</b>	—	—	mA	<b>Note 1</b> $V_{IN} \geq 3V$ and $V_{IN} \geq (V_R + 2.5\%) + V_{DROPOUTMAX}$
		<b>150</b>	—	—		
Output Voltage	$V_{OUT}$	<b><math>V_R - 2.5\%</math></b>	$V_R \pm 0.5\%$	<b><math>V_R + 2.5\%</math></b>	V	<b>Note 2</b>
$V_{OUT}$ Temperature Coefficient	$TCV_{OUT}$	—	<b>40</b>	—	ppm/ $^\circ C$	<b>Note 3</b>
Line Regulation	$ \Delta V_{OUT}/\Delta V_{IN}  / V_R$	—	0.04	<b>0.2</b>	%/V	$(V_R + 1V) < V_{IN} < 6V$
Load Regulation ( <b>Note 4</b> )	$ \Delta V_{OUT}  / V_R$	—	0.38	<b>1.5</b>	%	$I_L = 0.1 \text{ mA to } I_{OUTMAX}$
Dropout Voltage ( <b>Note 5</b> )	$V_{IN} - V_{OUT}$	—	2	—	mV	$I_L = 100 \mu A$ $I_L = 50 \text{ mA}$ $I_L = 100 \text{ mA}$ $I_L = 150 \text{ mA}$
		—	90	<b>200</b>		
		—	180	<b>350</b>		
		—	285	<b>500</b>		
Supply Current	$I_{IN}$	—	53	<b>90</b>	$\mu A$	$\overline{\text{SHDN}} = V_{IH}$ , $I_L = 0$
Shutdown Supply Current	$I_{INSD}$	—	0.05	2	$\mu A$	$\overline{\text{SHDN}} = 0V$
Power Supply Rejection Ratio	PSRR	—	58	—	dB	$f = 1 \text{ kHz}$ , $I_L = 50 \text{ mA}$

**Note 1:** The minimum  $V_{IN}$  has to meet two conditions:  $V_{IN} \geq 2.7V$  and  $V_{IN} \geq (V_R + 2.5\%) + V_{DROPOUT}$ .

**2:**  $V_R$  is the regulator voltage setting. For example:  $V_R = 1.8V, 2.7V, 2.8V, 3.0V$ .

**3:**

$$TCV_{OUT} = \frac{(V_{OUTMAX} - V_{OUTMIN}) \times 10^6}{V_{OUT} \times \Delta T}$$

**4:** Regulation is measured at a constant junction temperature using low duty-cycle pulse testing. Load regulation is tested over a load range from 0.1 mA to the maximum specified output current. Changes in output voltage due to heating effects are covered by the thermal regulation specification.

**5:** Dropout voltage is defined as the input-to-output differential at which the output voltage drops 2% below its nominal value at a 1V differential.

**6:** Thermal regulation is defined as the change in output voltage at a time T after a change in power dissipation is applied, excluding load or line regulation effects. Specifications are for a current pulse equal to  $I_{LMAX}$  at  $V_{IN} = 6V$  for  $t = 10 \text{ msec}$ .

**7:** The maximum allowable power dissipation is a function of ambient temperature, the maximum allowable junction temperature and the thermal resistance from junction-to-air (i.e.,  $T_A$ ,  $T_J$ ,  $\theta_{JA}$ ). Exceeding the maximum allowable power dissipation causes the device to initiate thermal shutdown. Please see **Section 5.1 “Thermal Shutdown”**, for more details.

**8:** Output current is limited to 120 mA (typ) when  $V_{OUT}$  is less than 0.5V due to a load fault or short-circuit condition.

## ELECTRICAL CHARACTERISTICS (CONTINUED)

<b>Electrical Specifications:</b> Unless otherwise noted, $V_{IN} = V_R + 1V$ , $I_L = 100 \mu A$ , $C_L = 1.0 \mu F$ , $\overline{SHDN} > V_{IH}$ , $T_A = +25^\circ C$ <b>Boldface</b> type specifications apply for junction temperatures of $-40^\circ C$ to $+125^\circ C$ .						
Parameter	Sym.	Min.	Typ.	Max.	Units	Test Conditions
Wake-Up Time (from Shutdown mode)	$t_{WK}$	—	10	—	$\mu s$	$V_{IN} = 5V$ , $I_L = 60 mA$ , $C_{IN} = C_{OUT} = 1 \mu F$ , $f = 100 Hz$
Settling Time (from Shutdown mode)	$t_S$	—	32	—	$\mu s$	$V_{IN} = 5V$ , $I_L = 60 mA$ , $C_{IN} = 1 \mu F$ , $C_{OUT} = 1 \mu F$ , $f = 100 Hz$
Output Short-Circuit Current	$I_{OUTSC}$	—	120	—	mA	$V_{OUT} = 0V$ , Average Current ( <b>Note 8</b> )
Thermal Regulation	$V_{OUT/PD}$	—	0.04	—	V/W	<b>Notes 6, 7</b>
Thermal Shutdown Die Temperature	$T_{SD}$	—	160	—	$^\circ C$	
Thermal Shutdown Hysteresis	$\Delta T_{SD}$	—	10	—	$^\circ C$	
Output Noise	eN	—	800	—	nV/ $\sqrt{Hz}$	$f = 10 kHz$
SHDN Input High Threshold	$V_{IH}$	<b>45</b>	—	—	% $V_{IN}$	$V_{IN} = 2.7V$ to $6.0V$
SHDN Input Low Threshold	$V_{IL}$	—	—	<b>15</b>	% $V_{IN}$	$V_{IN} = 2.7V$ to $6.0V$

**Note 1:** The minimum  $V_{IN}$  has to meet two conditions:  $V_{IN} \geq 2.7V$  and  $V_{IN} \geq (V_R + 2.5\%) + V_{DROPOUT}$ .

**2:**  $V_R$  is the regulator voltage setting. For example:  $V_R = 1.8V, 2.7V, 2.8V, 3.0V$ .

**3:**

$$TCV_{OUT} = \frac{(V_{OUTMAX} - V_{OUTMIN}) \times 10^6}{V_{OUT} \times \Delta T}$$

**4:** Regulation is measured at a constant junction temperature using low duty-cycle pulse testing. Load regulation is tested over a load range from 0.1 mA to the maximum specified output current. Changes in output voltage due to heating effects are covered by the thermal regulation specification.

**5:** Dropout voltage is defined as the input-to-output differential at which the output voltage drops 2% below its nominal value at a 1V differential.

**6:** Thermal regulation is defined as the change in output voltage at a time T after a change in power dissipation is applied, excluding load or line regulation effects. Specifications are for a current pulse equal to  $I_{LMAX}$  at  $V_{IN} = 6V$  for  $t = 10$  msec.

**7:** The maximum allowable power dissipation is a function of ambient temperature, the maximum allowable junction temperature and the thermal resistance from junction-to-air (i.e.,  $T_A$ ,  $T_J$ ,  $\theta_{JA}$ ). Exceeding the maximum allowable power dissipation causes the device to initiate thermal shutdown. Please see **Section 5.1 "Thermal Shutdown"**, for more details.

**8:** Output current is limited to 120 mA (typ) when  $V_{OUT}$  is less than 0.5V due to a load fault or short-circuit condition.

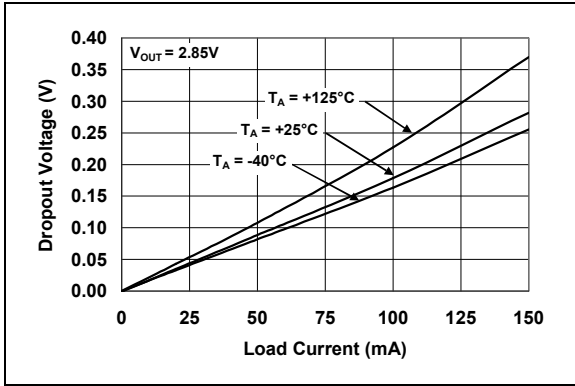
## TEMPERATURE CHARACTERISTICS

<b>Electrical Specifications:</b> Unless otherwise indicated, $V_{DD} = +2.7V$ to $+6.0V$ and $V_{SS} = GND$ .						
Parameters	Sym.	Min.	Typ.	Max.	Units	Conditions
<b>Temperature Ranges</b>						
Specified Temperature Range	$T_A$	-40	—	+125	$^\circ C$	Extended Temperature parts
Operating Temperature Range	$T_A$	-40	—	+125	$^\circ C$	
Storage Temperature Range	$T_A$	-65	—	+150	$^\circ C$	
<b>Thermal Package Resistances3</b>						
Thermal Resistance, 5L-SOT23	$\theta_{JA}$	—	255	—	$^\circ C/W$	
Thermal Resistance, 5L-SC-70	$\theta_{JA}$	—	450	—	$^\circ C/W$	

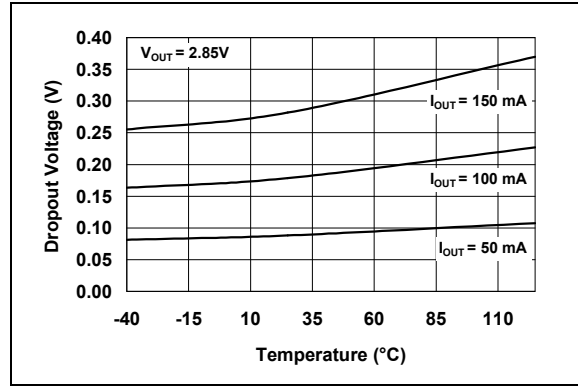
## 2.0 TYPICAL PERFORMANCE CHARACTERISTICS

**Note:** The graphs and tables provided following this note are a statistical summary based on a limited number of samples and are provided for informational purposes only. The performance characteristics listed herein are not tested or guaranteed. In some graphs or tables, the data presented may be outside the specified operating range (e.g., outside specified power supply range) and therefore outside the warranted range.

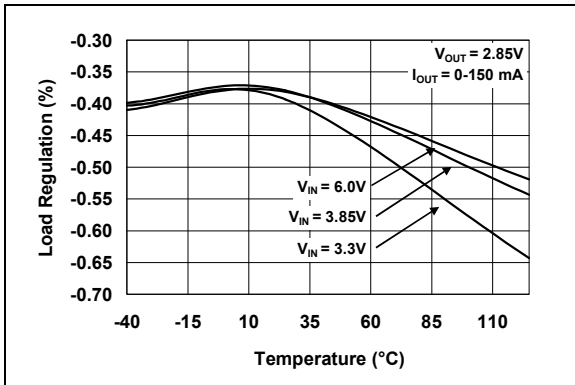
**Note:** Unless otherwise noted,  $V_{IN} = V_R + 1V$ ,  $I_L = 100 \mu A$ ,  $C_L = 1.0 \mu F$ ,  $SHDN > V_{IH}$ ,  $T_A = +25^\circ C$ .



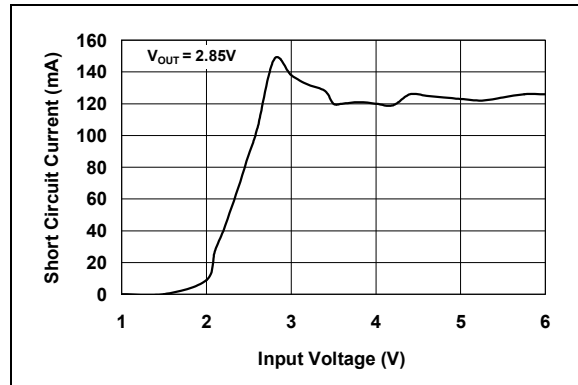
**FIGURE 2-1:** Dropout Voltage vs. Output Current.



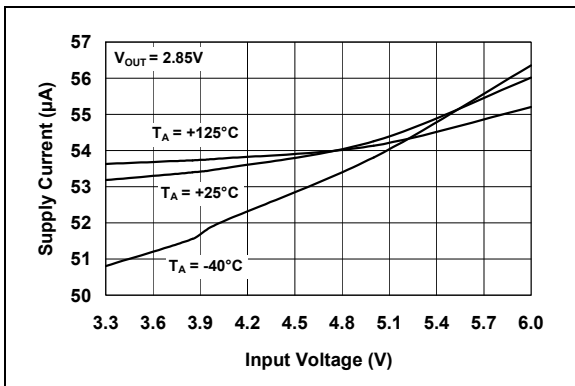
**FIGURE 2-4:** Dropout Voltage vs. Temperature.



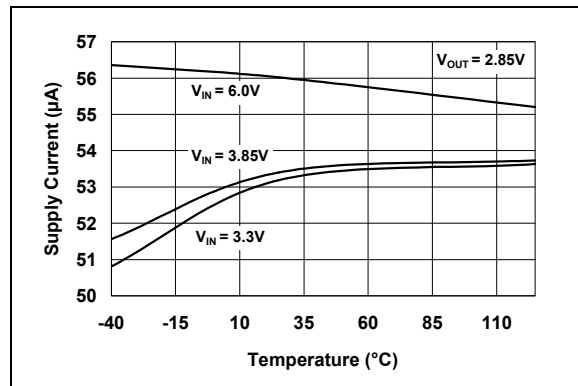
**FIGURE 2-2:** Load Regulation vs. Temperature.



**FIGURE 2-5:** Short-Circuit Current vs. Input Voltage.

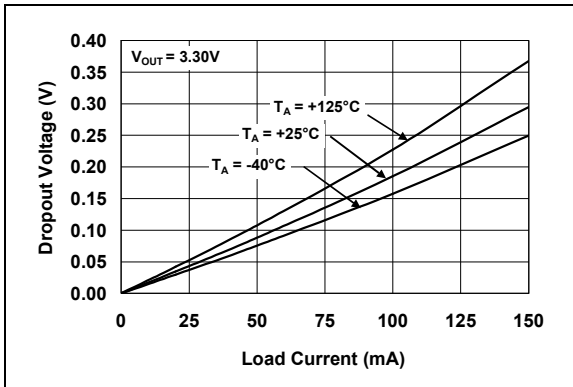


**FIGURE 2-3:** Supply Current vs. Input Voltage.

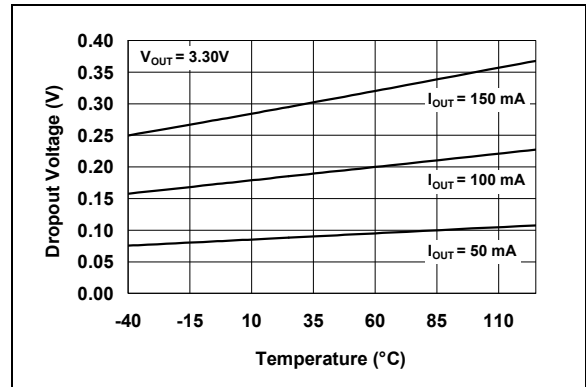


**FIGURE 2-6:** Supply Current vs. Temperature.

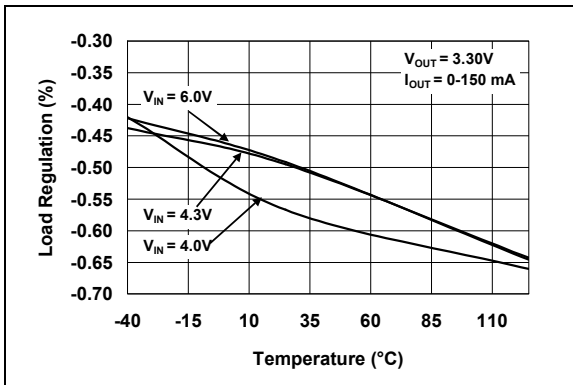
**Note:** Unless otherwise noted,  $V_{IN} = V_R + 1V$ ,  $I_L = 100 \mu A$ ,  $C_L = 1.0 \mu F$ ,  $\overline{SHDN} > V_{IH}$ ,  $T_A = +25^\circ C$ .



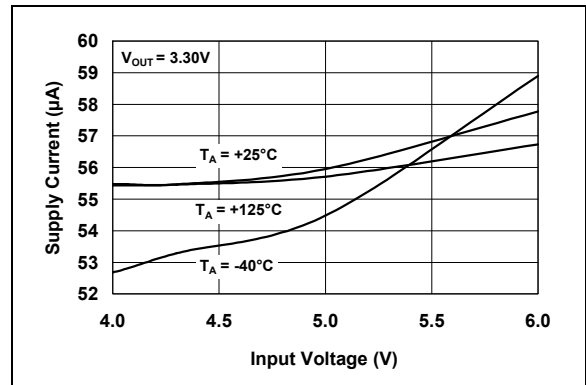
**FIGURE 2-7:** Dropout Voltage vs. Output Current.



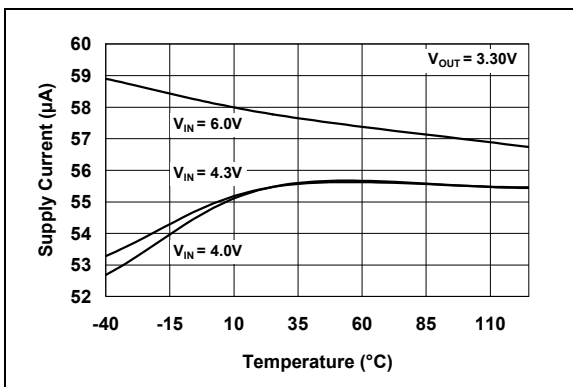
**FIGURE 2-10:** Dropout Voltage vs. Temperature.



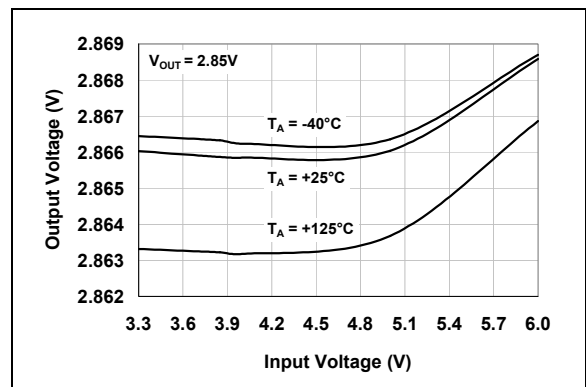
**FIGURE 2-8:** Load Regulation vs. Temperature.



**FIGURE 2-11:** Supply Current vs. Input Voltage.



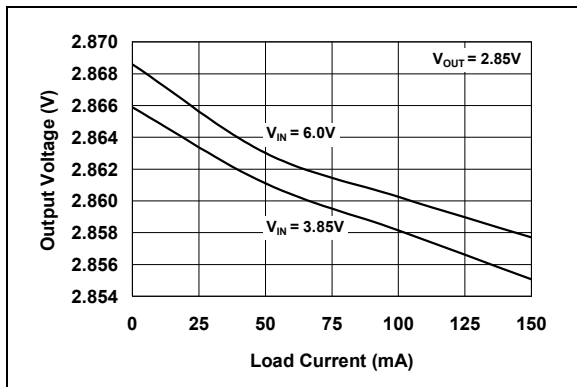
**FIGURE 2-9:** Supply Current vs. Temperature.



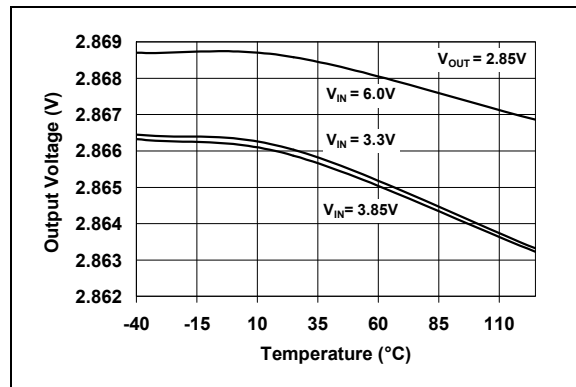
**FIGURE 2-12:** Output Voltage vs. Supply Voltage.

# TC1017

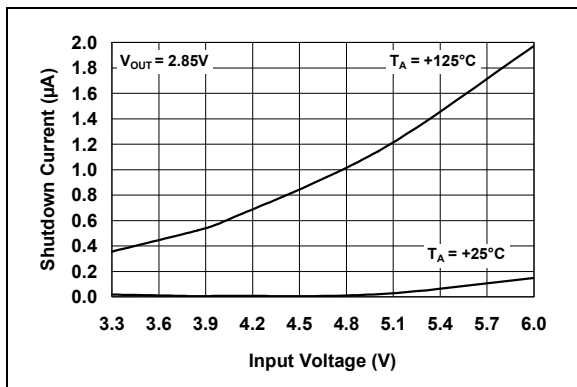
Note: Unless otherwise noted,  $V_{IN} = V_R + 1V$ ,  $I_L = 100 \mu A$ ,  $C_L = 1.0 \mu F$ ,  $\overline{SHDN} > V_{IH}$ ,  $T_A = +25^\circ C$ .



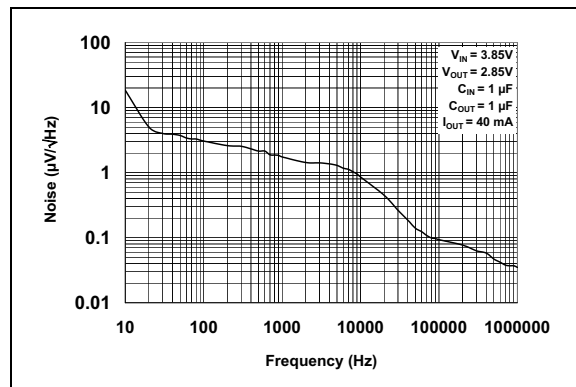
**FIGURE 2-13:** Output Voltage vs. Output Current.



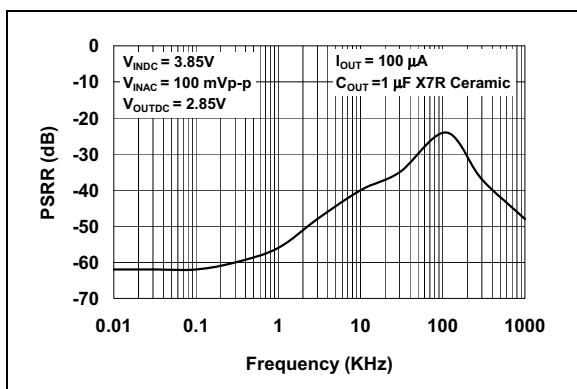
**FIGURE 2-16:** Output Voltage vs. Temperature.



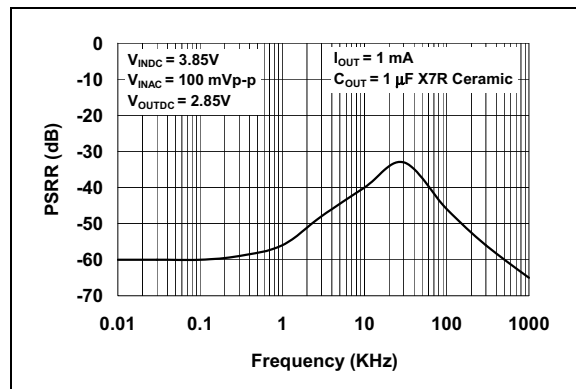
**FIGURE 2-14:** Shutdown Current vs. Input Voltage.



**FIGURE 2-17:** Output Noise vs. Frequency.

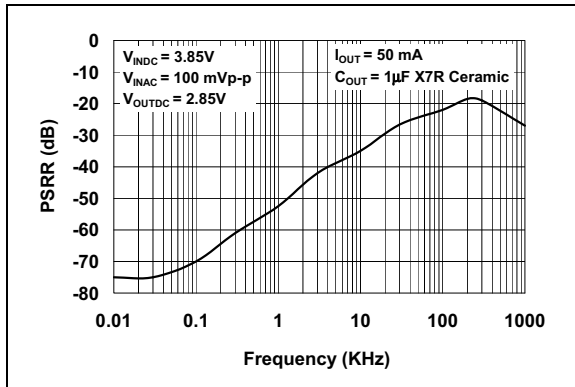


**FIGURE 2-15:** Power Supply Rejection Ratio vs. Frequency.

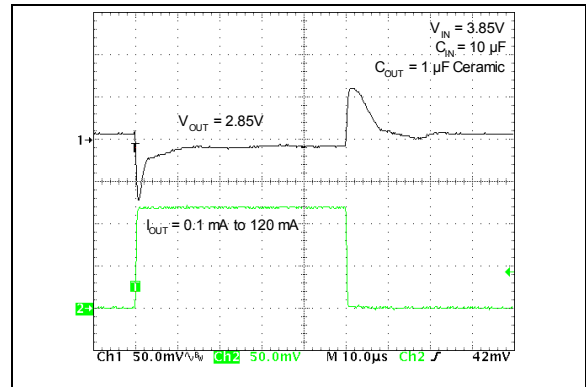


**FIGURE 2-18:** Power Supply Rejection Ratio vs. Frequency.

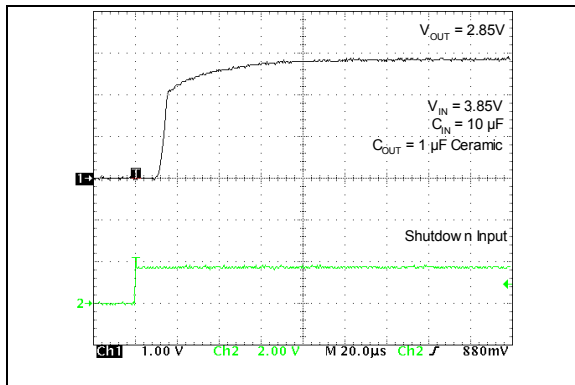
**Note:** Unless otherwise noted,  $V_{IN} = V_R + 1V$ ,  $I_L = 100 \mu A$ ,  $C_L = 1.0 \mu F$ ,  $\overline{SHDN} > V_{IH}$ ,  $T_A = +25^\circ C$ .



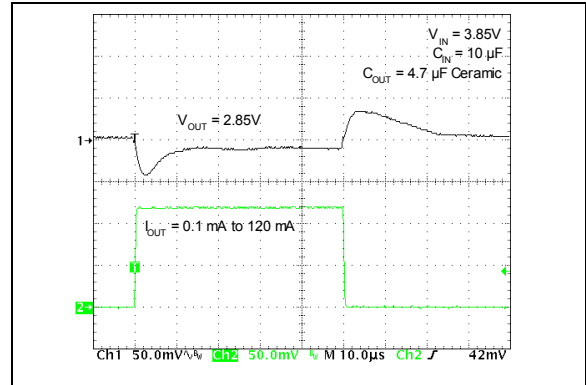
**FIGURE 2-19:** Power Supply Rejection Ratio vs. Frequency.



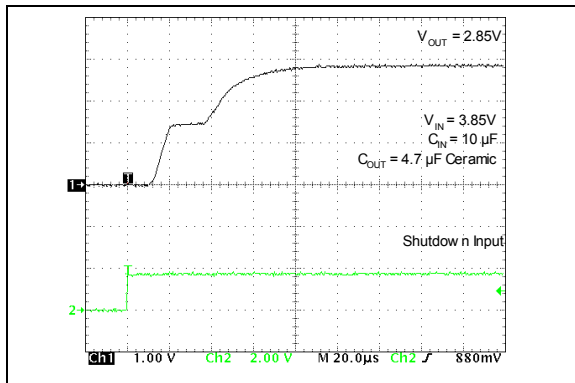
**FIGURE 2-22:** Load Transient Response.



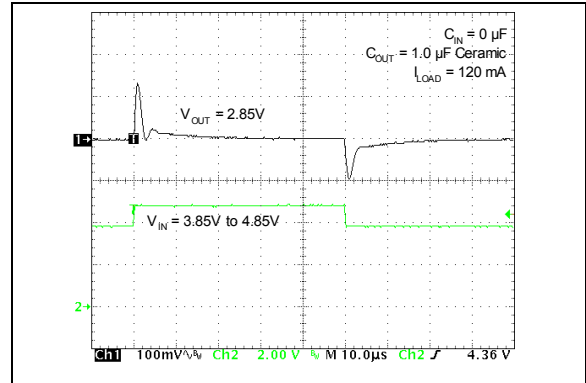
**FIGURE 2-20:** Wake-Up Response.



**FIGURE 2-23:** Load Transient Response.



**FIGURE 2-21:** Wake-Up Response.



**FIGURE 2-24:** Line Transient Response.

# TC1017

Note: Unless otherwise noted,  $V_{IN} = V_R + 1V$ ,  $I_L = 100 \mu A$ ,  $C_L = 1.0 \mu F$ ,  $\overline{SHDN} > V_{IH}$ ,  $T_A = +25^\circ C$ .

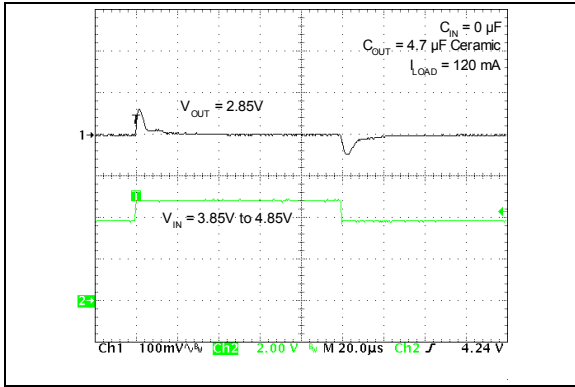


FIGURE 2-25: Line Transient Response.

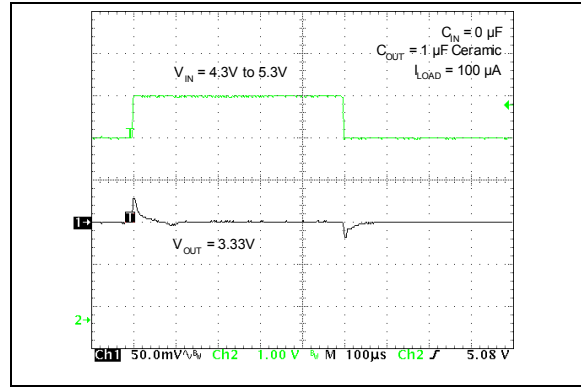


FIGURE 2-26: Line Transient Response.

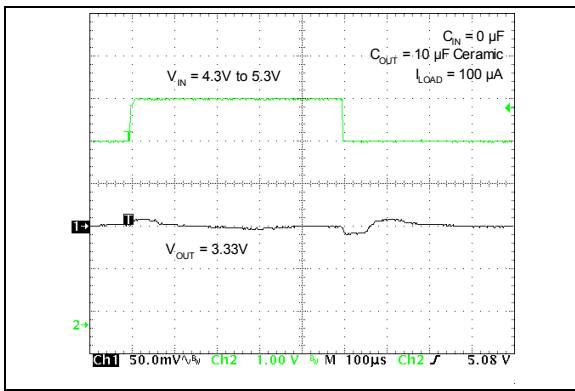


FIGURE 2-27: Line Transient Response.



## 3.0 PIN DESCRIPTIONS

The descriptions of the pins are listed in [Table 3-1](#).

**TABLE 3-1: PIN FUNCTION TABLE**

Pin No. 5-Pin SC-70	Pin No. 5-Pin SOT-23 5-Pin SC-70R	Symbol	Description
1	3	$\overline{\text{SHDN}}$	Shutdown Control Input
2	4	NC	No Connect
3	2	GND	Ground Terminal
4	5	$V_{\text{OUT}}$	Regulated Voltage Output
5	1	$V_{\text{IN}}$	Unregulated Supply Input

### 3.1 Shutdown Control Input ( $\overline{\text{SHDN}}$ )

The regulator is fully enabled when a logic-high is applied to  $\overline{\text{SHDN}}$ . The regulator enters shutdown when a logic-low is applied to this input. During shutdown, the output voltage falls to zero and the supply current is reduced to 0.05  $\mu\text{A}$  (typ.)

### 3.2 Ground Terminal

For best performance, it is recommended that the ground pin be tied to a ground plane.

### 3.3 Regulated Voltage Output ( $V_{\text{OUT}}$ )

Bypass the regulated voltage output to GND with a minimum capacitance of 1  $\mu\text{F}$ . A ceramic bypass capacitor is recommended for best performance.

### 3.4 Unregulated Supply Input ( $V_{\text{IN}}$ )

The minimum  $V_{\text{IN}}$  has to meet two conditions in order to ensure that the output maintains regulation:  $V_{\text{IN}} \geq 2.7\text{V}$  and  $V_{\text{IN}} \geq [(V_{\text{R}} + 2.5\%) + V_{\text{DROPOUT}}]$ . The maximum  $V_{\text{IN}}$  should be less than or equal to 6V. Power dissipation may limit  $V_{\text{IN}}$  to a lower potential in order to maintain a junction temperature below 125°C. Refer to [Section 5.0 "Thermal Considerations"](#), for determining junction temperature.

It is recommended that  $V_{\text{IN}}$  be bypassed to GND with a ceramic capacitor.

# TC1017

## 4.0 DETAILED DESCRIPTION

The TC1017 is a precision, fixed-output, linear voltage regulator. The internal linear pass element is a P-channel MOSFET. As with all P-channel CMOS LDOs, there is a body drain diode with the cathode connected to  $V_{IN}$  and the anode connected to  $V_{OUT}$  (Figure 4-1).

As is shown in Figure 4-1, the output voltage of the LDO is sensed and divided down internally to reduce external component count. The internal error amplifier has a fixed bandgap reference on the inverting input and the sensed output voltage on the non-inverting input. The error amplifier output will pull the gate voltage down until the inputs of the error amplifier are equal to regulate the output voltage.

Output overload protection is implemented by sensing the current in the P-channel MOSFET. During a shorted or faulted load condition in which the output voltage falls to less than 0.5V, the output current is limited to a typical value of 120 mA. The current-limit protection helps prevent excessive current from damaging the Printed Circuit Board (PCB).

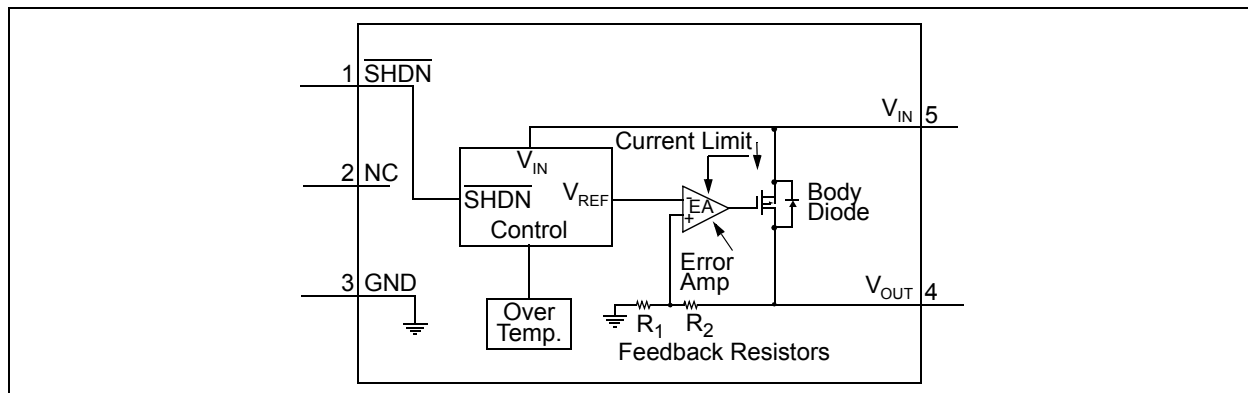
An internal thermal sensing device is used to monitor the junction temperature of the LDO. When the sensed temperature is over the set threshold of 160°C (typical), the P-channel MOSFET is turned off. When the P-channel is off, the power dissipation internal to the device is almost zero. The device cools until the junction tem-

perature is approximately 150°C and the P-channel is turned on. If the internal power dissipation is still high enough for the junction to rise to 160°C, it will again shut off and cool. The maximum operating junction temperature of the device is 125°C. Steady-state operation at or near the 160°C overtemperature point can lead to permanent damage of the device.

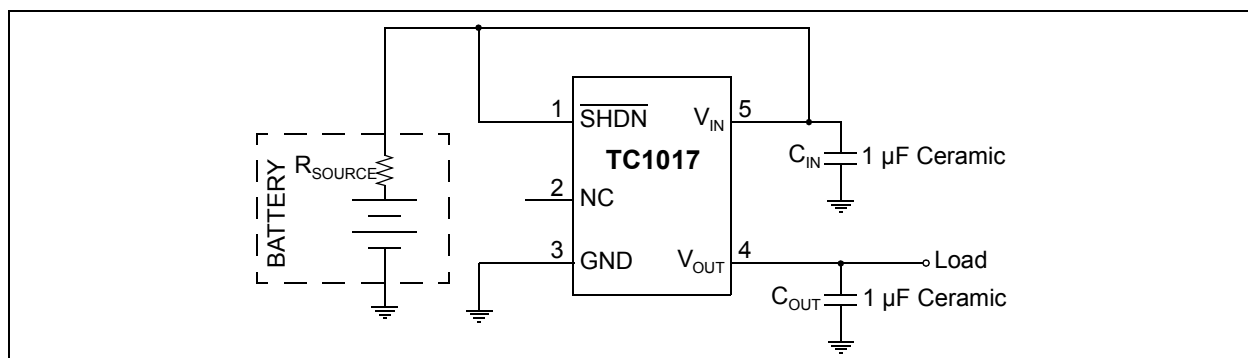
The output voltage  $V_{OUT}$  remains stable over the entire input operating voltage range (2.7V to 6.0V) and the entire load range (0 mA to 150 mA). The output voltage is sensed through an internal resistor divider and compared with a precision internal voltage reference. Several fixed-output voltages are available by changing the value of the internal resistor divider.

Figure 4-2 shows a typical application circuit. The regulator is enabled any time the shutdown input pin is at or above  $V_{IH}$ . It is shut down (disabled) any time the shutdown input pin is below  $V_{IL}$ . For applications where the SHDN feature is not used, tie the SHDN pin directly to the input supply voltage source. While in shutdown, the supply current decreases to 0.006  $\mu$ A (typical) and the P-channel MOSFET is turned off.

As shown in Figure 4-2, batteries have internal source impedance. An input capacitor is used to lower the input impedance of the LDO. In some applications, high input impedance can cause the LDO to become unstable. Adding more input capacitance can compensate for this.



**FIGURE 4-1:** TC1017 Block Diagram (5-Pin SC-70 Pinout).



**FIGURE 4-2:** Typical Application Circuit (5-Pin SC-70 Pinout).

## 4.1 Input Capacitor

Low input source impedance is necessary for the LDO to operate properly. When operating from batteries, or in applications with long lead length (> 10") between the input source and the LDO, some input capacitance is required. A minimum of 0.1  $\mu\text{F}$  is recommended for most applications and the capacitor should be placed as close to the input of the LDO as is practical. Larger input capacitors will help reduce the input impedance and further reduce any high-frequency noise on the input and output of the LDO.

## 4.2 Output Capacitor

A minimum output capacitance of 1  $\mu\text{F}$  for the TC1017 is required for stability. The Equivalent Series Resistance (ESR) requirements on the output capacitor are between 0 and 2 ohms. The output capacitor should be located as close to the LDO output as is practical. Ceramic materials X7R and X5R have low temperature coefficients and are well within the acceptable ESR range required. A typical 1  $\mu\text{F}$  X5R 0805 capacitor has an ESR of 50 milli-ohms. Larger output capacitors can be used with the TC1017 to improve dynamic behavior and input ripple-rejection performance.

Ceramic, aluminum electrolytic or tantalum capacitor types can be used. Since many aluminum electrolytic capacitors freeze at approximately  $-30^{\circ}\text{C}$ , ceramic or solid tantalums are recommended for applications operating below  $-25^{\circ}\text{C}$ . When operating from sources other than batteries, supply-noise rejection and transient response can be improved by increasing the value of the input and output capacitors and employing passive filtering techniques.

## 4.3 Turn-On Response

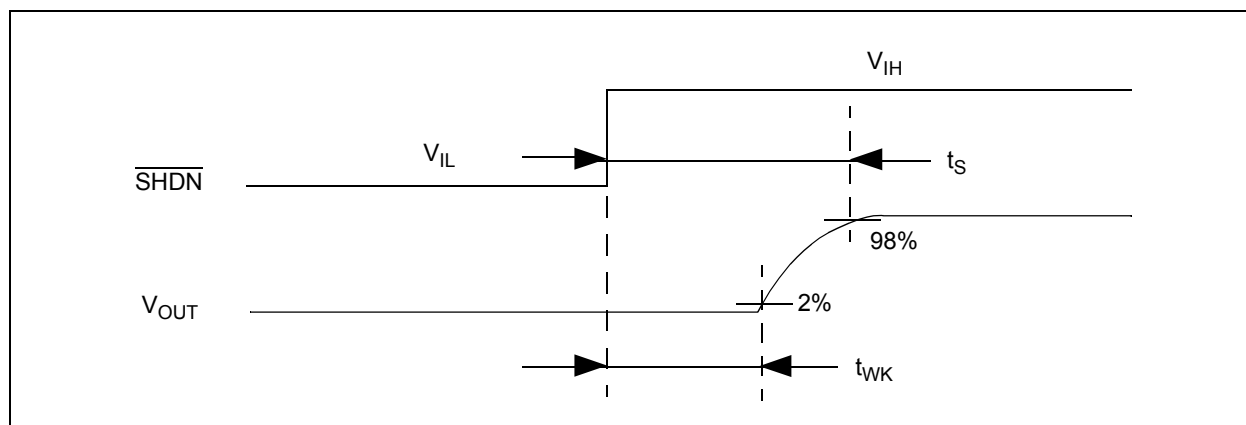
The turn-on response is defined as two separate response categories, wake-up time ( $t_{\text{WK}}$ ) and settling time ( $t_{\text{S}}$ ).

The TC1017 has a fast wake-up time (10  $\mu\text{sec}$ , typical) when released from shutdown. See Figure 4-3 for the wake-up time designated as  $t_{\text{WK}}$ . The wake-up time is defined as the time it takes for the output to rise to 2% of the  $V_{\text{OUT}}$  value after being released from shutdown.

The total turn-on response is defined as the settling time ( $t_{\text{S}}$ ) (see Figure 4-3). Settling time (inclusive with  $t_{\text{WK}}$ ) is defined as the condition when the output is within 98% of its fully-enabled value (32  $\mu\text{sec}$ , typical) when released from shutdown. The settling time of the output voltage is dependent on load conditions and output capacitance on  $V_{\text{OUT}}$  (RC response).

The table below demonstrates the typical turn-on response timing for different input voltage power-up frequencies:  $V_{\text{OUT}} = 2.85\text{V}$ ,  $V_{\text{IN}} = 5.0\text{V}$ ,  $I_{\text{OUT}} = 60\text{mA}$  and  $C_{\text{OUT}} = 1\ \mu\text{F}$ .

Frequency	Typical ( $t_{\text{WK}}$ )	Typical ( $t_{\text{S}}$ )
1000 Hz	5.3 $\mu\text{sec}$	14 $\mu\text{sec}$
500 Hz	5.9 $\mu\text{sec}$	16 $\mu\text{sec}$
100 Hz	9.8 $\mu\text{sec}$	32 $\mu\text{sec}$
50 Hz	14.5 $\mu\text{sec}$	52 $\mu\text{sec}$
10 Hz	17.2 $\mu\text{sec}$	77 $\mu\text{sec}$



**FIGURE 4-3:** Wake-Up Time from Shutdown.

## 5.0 THERMAL CONSIDERATIONS

### 5.1 Thermal Shutdown

Integrated thermal protection circuitry shuts the regulator off when the die temperature exceeds approximately 160°C. The regulator remains off until the die temperature drops to approximately 150°C.

### 5.2 Power Dissipation: SC-70

The TC1017 is available in the SC-70 package. The thermal resistance for the SC-70 package is approximately 450°C/W when the copper area used in the PCB layout is similar to the JEDEC J51-7 high thermal conductivity standard or semi-G42-88 standard. For applications with a larger or thicker copper area, the thermal resistance can be lowered. See AN792, "A Method to Determine How Much Power a SOT-23 Can Dissipate in an Application" (DS00792), for a method to determine the thermal resistance for a particular application.

The TC1017 power dissipation capability is dependant upon several variables: input voltage, output voltage, load current, ambient temperature and maximum junction temperature. The absolute maximum steady-state junction temperature is rated at +125°C. The power dissipation within the device is equal to:

#### EQUATION 5-1:

$$P_D = (V_{IN} - V_{OUT}) \times I_{LOAD} + V_{IN} \times I_{GND}$$

The  $V_{IN} \times I_{GND}$  term is typically very small when compared to the  $(V_{IN} - V_{OUT}) \times I_{LOAD}$  term, simplifying the power dissipation within the LDO to be:

#### EQUATION 5-2:

$$P_D = (V_{IN} - V_{OUT}) \times I_{LOAD}$$

To determine the maximum power dissipation capability, the following equation is used:

#### EQUATION 5-3:

$$P_{D_{MAX}} = \frac{(T_{J_{MAX}} - T_{A_{MAX}})}{R\theta_{JA}}$$

Where:

$T_{J_{MAX}}$  = the maximum junction temperature allowed

$T_{A_{MAX}}$  = the maximum ambient temperature

$R\theta_{JA}$  = the thermal resistance from junction to air

Given the following example:

$$V_{IN} = 3.0V \text{ to } 4.1V$$

$$V_{OUT} = 2.85V \pm 2.5\%$$

$$I_{LOAD} = 120 \text{ mA (output current)}$$

$$T_A = 55^\circ\text{C (max. desired ambient)}$$

Find:

1. Internal power dissipation:

$$\begin{aligned} P_{D_{MAX}} &= (V_{IN_{MAX}} - V_{OUT_{MIN}}) \times I_{LOAD} \\ &= (4.1V - 2.85 \times (0.975)) \times 120\text{mA} \\ &= 158.5\text{mW} \end{aligned}$$

2. Maximum allowable ambient temperature:

$$\begin{aligned} T_{A_{MAX}} &= T_{J_{MAX}} - P_{D_{MAX}} \times R\theta_{JA} \\ &= (125^\circ\text{C} - 158.5\text{mW} \times 450^\circ\text{C/W}) \\ &= (125^\circ\text{C} - 71^\circ\text{C}) \\ &= 54^\circ\text{C} \end{aligned}$$

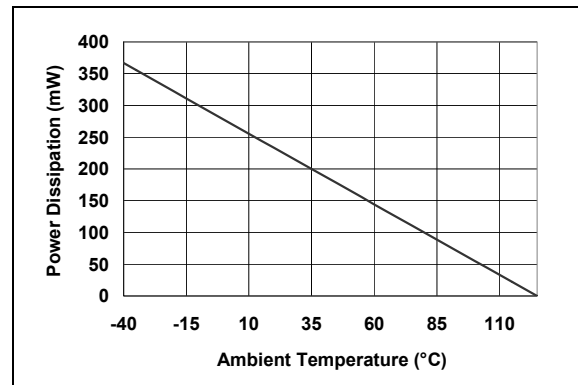
3. Maximum allowable power dissipation at desired ambient:

$$\begin{aligned} P_D &= \frac{T_{J_{MAX}} - T_A}{R\theta_{JA}} \\ &= \frac{125^\circ\text{C} - 55^\circ\text{C}}{450^\circ\text{C/W}} \\ &= 155\text{mW} \end{aligned}$$

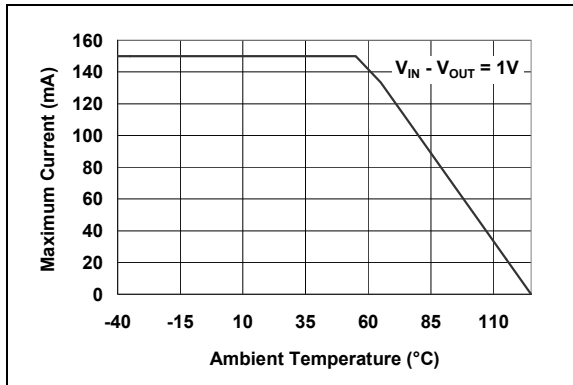
In this example, the TC1017 dissipates approximately 158.5 mW and the junction temperature is raised 71°C over the ambient. The absolute maximum power dissipation is 155 mW when given a maximum ambient temperature of 55°C.

Input voltage, output voltage or load current limits can also be determined by substituting known values in the power dissipation equations.

Figure 5-1 and Figure 5-2 depict typical maximum power dissipation versus ambient temperature, as well as typical maximum current versus ambient temperature, with a 1V input voltage to output voltage differential, respectively.



**FIGURE 5-1:** Power Dissipation vs. Ambient Temperature (SC-70 package).



**FIGURE 5-2:** Maximum Current vs. Ambient Temperature (SC-70 package).

### 5.3 Power Dissipation: SOT-23

The TC1017 is also available in a SOT-23 package for improved thermal performance. The thermal resistance for the SOT-23 package is approximately 255°C/W when the copper area used in the printed circuit board layout is similar to the JEDEC J51-7 low thermal conductivity standard or semi-G42-88 standard. For applications with a larger or thicker copper area, the thermal resistance can be lowered. See AN792, “A Method to Determine How Much Power a SOT-23 Can Dissipate in an Application” (DS00792), for a method to determine the thermal resistance for a particular application.

The TC1017 power dissipation capability is dependant upon several variables: input voltage, output voltage, load current, ambient temperature and maximum junction temperature. The absolute maximum steady-state junction temperature is rated at +125°C. The power dissipation within the device is equal to:

#### EQUATION 5-4:

$$P_D = (V_{IN} - V_{OUT}) \times I_{LOAD} + V_{IN} \times I_{GND}$$

The  $V_{IN} \times I_{GND}$  term is typically very small when compared to the  $(V_{IN} - V_{OUT}) \times I_{LOAD}$  term, simplifying the power dissipation within the LDO to be:

#### EQUATION 5-5:

$$P_D = (V_{IN} - V_{OUT}) \times I_{LOAD}$$

To determine the maximum power dissipation capability, the following equation is used:

#### EQUATION 5-6:

$$P_{D_{MAX}} = \frac{(T_{J\_MAX} - T_{A\_MAX})}{R\theta_{JA}}$$

Where:

$T_{J\_MAX}$  = the maximum junction temperature allowed

$T_{A\_MAX}$  = the maximum ambient temperature

$R\theta_{JA}$  = the thermal resistance from junction to air

Given the following example:

$$V_{IN} = 3.0V \text{ to } 4.1V$$

$$V_{OUT} = 2.85V \pm 2.5\%$$

$$I_{LOAD} = 120 \text{ mA (output current)}$$

$$T_A = +85^\circ\text{C (max. desired ambient)}$$

Find:

1. Internal power dissipation:

$$\begin{aligned} P_{D_{MAX}} &= (V_{IN\_MAX} - V_{OUT\_MIN}) \times I_{LOAD} \\ &= (4.1V - 2.85 \times (0.975)) \times 120mA \\ &= 158.5mW \end{aligned}$$

2. Maximum allowable ambient temperature:

$$\begin{aligned} T_{A\_MAX} &= T_{J\_MAX} - P_{D_{MAX}} \times R\theta_{JA} \\ &= (125^\circ\text{C} - 158.5mW \times 255^\circ\text{C/W}) \\ &= (125^\circ\text{C} - 40.5^\circ\text{C}) \\ &= 84.5^\circ\text{C} \end{aligned}$$

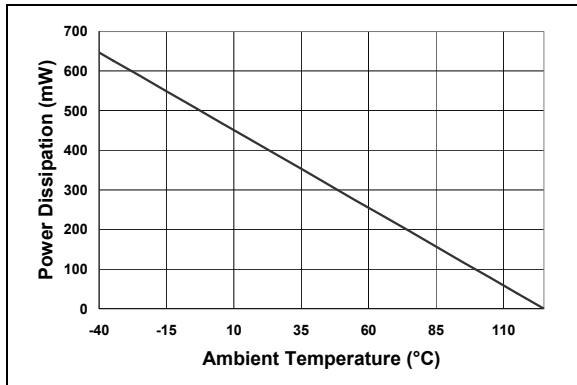
3. Maximum allowable power dissipation at desired ambient:

$$\begin{aligned} P_D &= \frac{T_{J\_MAX} - T_A}{R\theta_{JA}} \\ &= \frac{125^\circ\text{C} - 85^\circ\text{C}}{255^\circ\text{C/W}} \\ &= 157mW \end{aligned}$$

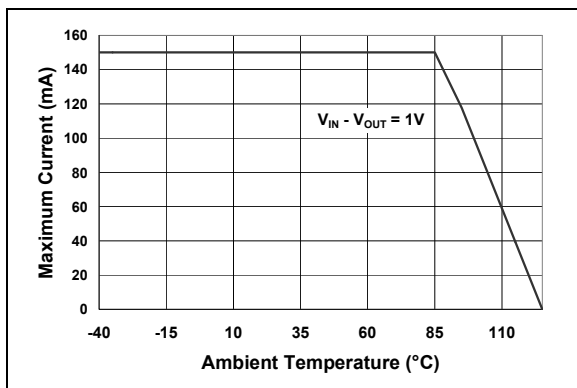
In this example, the TC1017 dissipates approximately 158.5mW and the junction temperature is raised 40.5°C over the ambient. The absolute maximum power dissipation is 157 mW when given a maximum ambient temperature of +85°C.

Input voltage, output voltage or load current limits can also be determined by substituting known values in the power dissipation equations.

Figure 5-3 and Figure 5-4 depict typical maximum power dissipation versus ambient temperature, as well as typical maximum current versus ambient temperature with a 1V input voltage to output voltage differential, respectively.



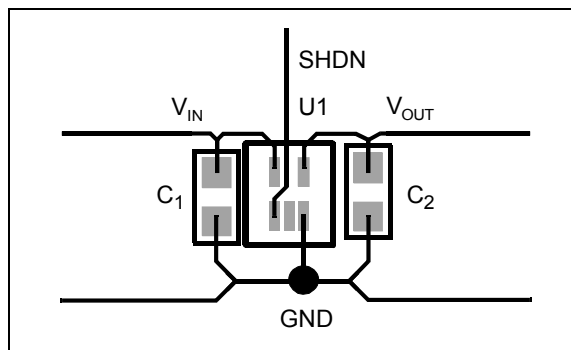
**FIGURE 5-3:** Power Dissipation vs. Ambient Temperature (SOT-23 Package).



**FIGURE 5-4:** Maximum Current vs. Ambient Temperature (SOT-23 Package).

## 5.4 Layout Considerations

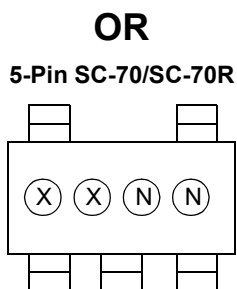
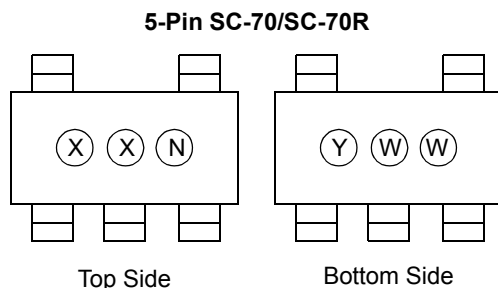
The primary path for heat conduction out of the SC-70/SOT-23 package is through the package leads. Using heavy, wide traces at the pads of the device will facilitate the removal of the heat within the package, thus lowering the thermal resistance  $R_{\theta JA}$ . By lowering the thermal resistance, the maximum internal power dissipation capability of the package is increased.



**FIGURE 5-5:** SC-70 Package Suggested Layout.

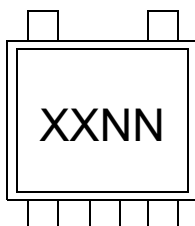
## 6.0 PACKAGE INFORMATION

### 6.1 Package Marking Information



Part Number	TC1017 Pinout Code	TC1017R Pinout Code
TC1017 – 1.8VLT	CE	CU
TC1017 – 1.85VLT	CQ	DF
TC1017 – 1.9VLT	CB	
TC1017 – 2.5VLT	CR	CV
TC1017 – 2.6VLT	CF	CW
TC1017 – 2.7VLT	CG	CX
TC1017 – 2.8VLT	CH	CY
TC1017 – 2.85VLT	CJ	CZ
TC1017 – 2.9VLT	CK	DA
TC1017 – 3.0VLT	CL	DB
TC1017 – 3.2VLT	CC	DC
TC1017 – 3.3VLT	CM	DD
TC1017 – 4.0VLT	CP	DE

#### 5-Lead SOT-23



Part Number	Code
TC1017 – 1.8VCT	DA
TC1017 – 1.85VCT	DK
TC1017 – 2.6VCT	DB
TC1017 – 2.7VCT	DC
TC1017 – 2.8VCT	DD
TC1017 – 2.85VCT	DE
TC1017 – 2.9VCT	DF
TC1017 – 3.0VCT	DG
TC1017 – 3.3VCT	DH
TC1017 – 4.0VCT	DJ

#### Example:



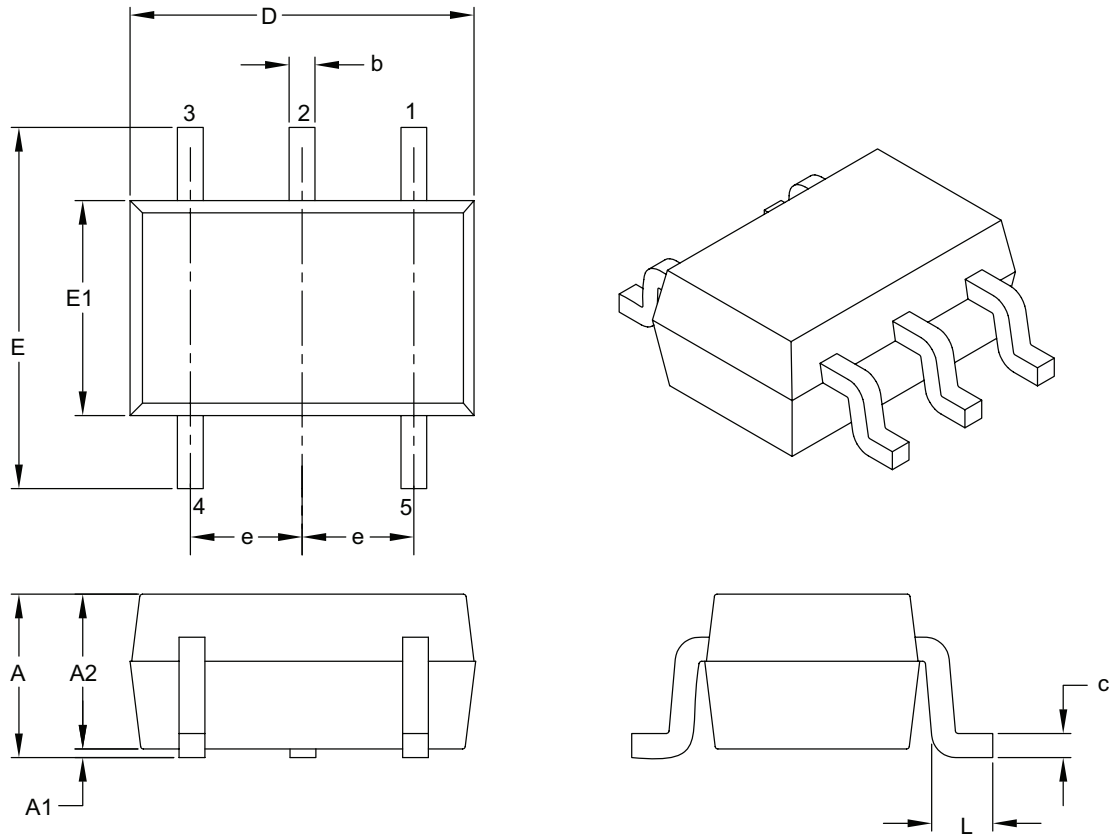
<b>Legend:</b>	XX...X	Customer-specific information*
	Y	Year code (last digit of calendar year)
	YY	Year code (last 2 digits of calendar year)
	WW	Week code (week of January 1 is week '01')
	NNN	Alphanumeric traceability code
	(e3)	Pb-free JEDEC designator for Matte Tin (Sn)
	*	This package is Pb-free. The Pb-free JEDEC designator (e3) can be found on the outer packaging for this package.

**Note:** In the event the full Microchip part number cannot be marked on one line, it will be carried over to the next line, thus limiting the number of available characters for customer-specific information.

# TC1017

## 5-Lead Plastic Small Outline Transistor (LT) [SC70]

**Note:** For the most current package drawings, please see the Microchip Packaging Specification located at <http://www.microchip.com/packaging>



Dimension Limits	Units	MILLIMETERS		
		MIN	NOM	MAX
Number of Pins	N	5		
Pitch	e	0.65 BSC		
Overall Height	A	0.80	–	1.10
Molded Package Thickness	A2	0.80	–	1.00
Standoff	A1	0.00	–	0.10
Overall Width	E	1.80	2.10	2.40
Molded Package Width	E1	1.15	1.25	1.35
Overall Length	D	1.80	2.00	2.25
Foot Length	L	0.10	0.20	0.46
Lead Thickness	c	0.08	–	0.26
Lead Width	b	0.15	–	0.40

**Notes:**

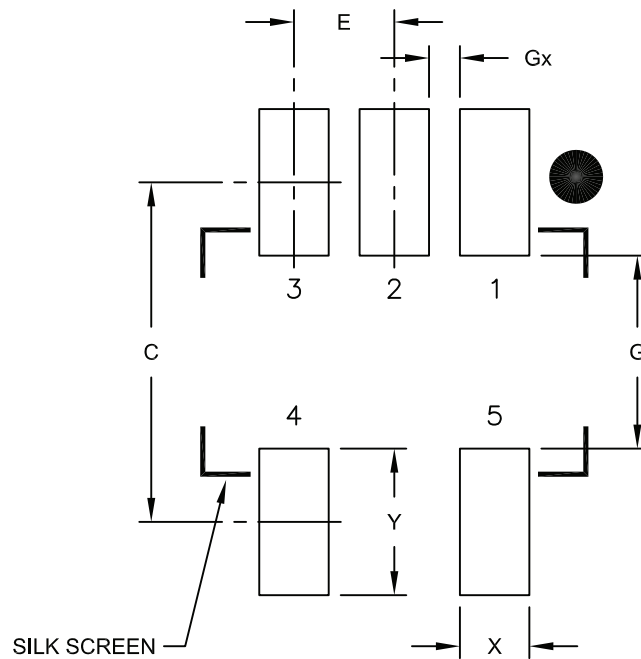
- Dimensions D and E1 do not include mold flash or protrusions. Mold flash or protrusions shall not exceed 0.127 mm per side.
- Dimensioning and tolerancing per ASME Y14.5M.  
BSC: Basic Dimension. Theoretically exact value shown without tolerances.

Microchip Technology Drawing C04-061B



## 5-Lead Plastic Small Outline Transistor (LT) [SC70]

**Note:** For the most current package drawings, please see the Microchip Packaging Specification located at <http://www.microchip.com/packaging>



RECOMMENDED LAND PATTERN

Dimension Limits	Units	MILLIMETERS		
		MIN	NOM	MAX
Contact Pitch	E	0.65 BSC		
Contact Pad Spacing	C		2.20	
Contact Pad Width	X			0.45
Contact Pad Length	Y			0.95
Distance Between Pads	G	1.25		
Distance Between Pads	Gx	0.20		

**Notes:**

1. Dimensioning and tolerancing per ASME Y14.5M

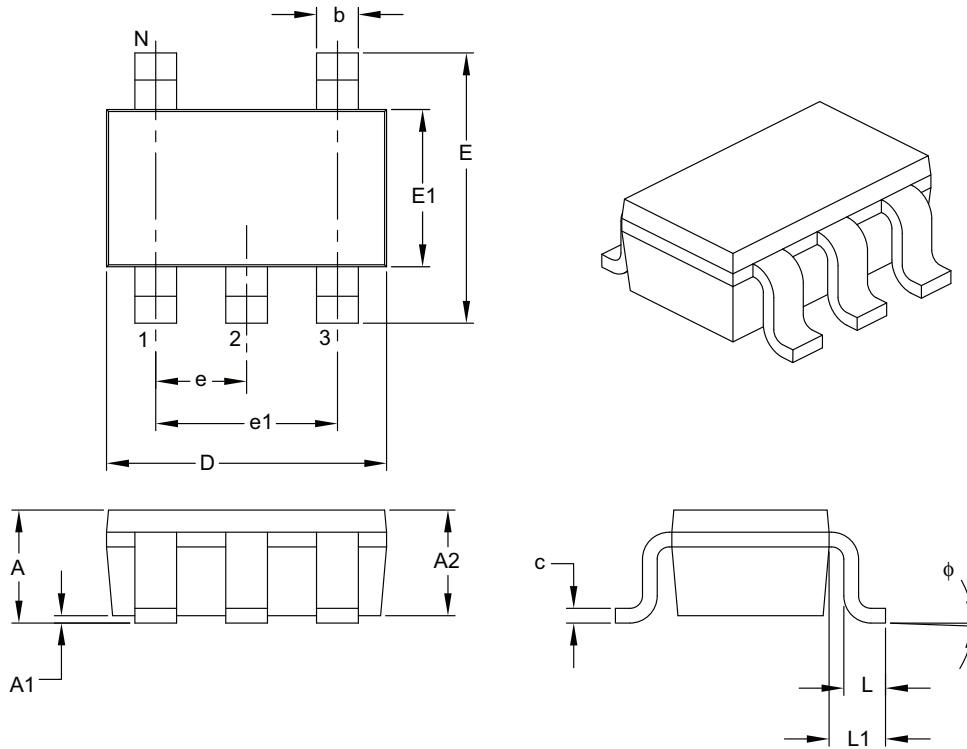
BSC: Basic Dimension. Theoretically exact value shown without tolerances.

Microchip Technology Drawing No. C04-2061A

# TC1017

## 5-Lead Plastic Small Outline Transistor (OT) [SOT-23]

**Note:** For the most current package drawings, please see the Microchip Packaging Specification located at <http://www.microchip.com/packaging>



Dimension Limits	Units	MILLIMETERS		
		MIN	NOM	MAX
Number of Pins	N	5		
Lead Pitch	e	0.95 BSC		
Outside Lead Pitch	e1	1.90 BSC		
Overall Height	A	0.90	–	1.45
Molded Package Thickness	A2	0.89	–	1.30
Standoff	A1	0.00	–	0.15
Overall Width	E	2.20	–	3.20
Molded Package Width	E1	1.30	–	1.80
Overall Length	D	2.70	–	3.10
Foot Length	L	0.10	–	0.60
Footprint	L1	0.35	–	0.80
Foot Angle	$\phi$	0°	–	30°
Lead Thickness	c	0.08	–	0.26
Lead Width	b	0.20	–	0.51

**Notes:**

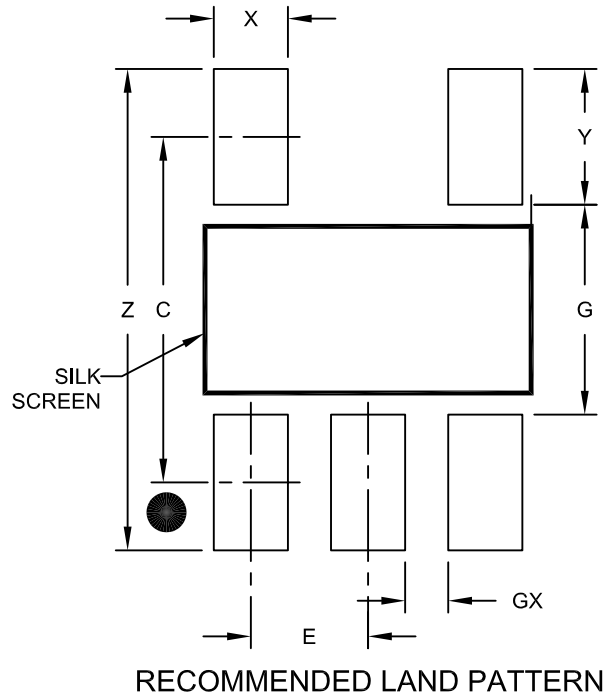
- Dimensions D and E1 do not include mold flash or protrusions. Mold flash or protrusions shall not exceed 0.127 mm per side.
- Dimensioning and tolerancing per ASME Y14.5M.

BSC: Basic Dimension. Theoretically exact value shown without tolerances.

Microchip Technology Drawing C04-091B

## 5-Lead Plastic Small Outline Transistor (OT) [SOT-23]

**Note:** For the most current package drawings, please see the Microchip Packaging Specification located at <http://www.microchip.com/packaging>



Dimension Limits	Units	MILLIMETERS		
		MIN	NOM	MAX
Contact Pitch	E	0.95 BSC		
Contact Pad Spacing	C		2.80	
Contact Pad Width (X5)	X			0.60
Contact Pad Length (X5)	Y			1.10
Distance Between Pads	G	1.70		
Distance Between Pads	GX	0.35		
Overall Width	Z			3.90

**Notes:**

1. Dimensioning and tolerancing per ASME Y14.5M

BSC: Basic Dimension. Theoretically exact value shown without tolerances.

Microchip Technology Drawing No. C04-2091A

# TC1017

---

NOTES:

## APPENDIX A: REVISION HISTORY

### Revision F (April 2013)

The following is the list of modifications:

- Updated the information for the Maximum Output Current parameter in the [Electrical Characteristics](#) table.

### Revision E (January 2013)

- Added a note to each package outline drawing.

### Revision D (February 2005)

- Undocumented changes.

# TC1017

---

NOTES:

## PRODUCT IDENTIFICATION SYSTEM

To order or obtain information, e.g., on pricing or delivery, refer to the factory or the listed sales office.

<u>PART NO.</u>	<u>X.XX</u>	<u>X</u>	<u>XXXX</u>	<b>Examples:</b>
Device	Voltage Options	Temperature Range	Package	
<b>Device:</b>	TC1017: 150 mA Tiny CMOS LDO with Shutdown TC1017R: 150 mA Tiny CMOS LDO with Shutdown (SC-70 only)			a) TC1017-1.8VLTR: 150 mA, Tiny CMOS LDO with Shutdown, SC-70 package.
<b>Voltage Options:*</b> <b>(Standard)</b>	1.8V 1.85V 2.5V SC-70 only 2.6V 2.7V 2.8V 2.85V 2.9V 3.0V 3.2V SC-70 only 3.3V 4.0V			b) TC1017R-1.8VLTR: 150mA, Tiny CMOS LDO with Shutdown, SC-70R package.
	* Other voltage options available. Please contact your local Microchip sales office for details.			c) TC1017-2.6VCTTR: 150 mA, Tiny CMOS LDO with Shutdown, SOT-23 package.
<b>Temperature Range:</b>	V = -40°C to +125°C			d) TC1017-2.7VLTR: 150 mA, Tiny CMOS LDO with Shutdown, SC-70 package.
<b>Package:</b>	LTTR = 5-pin SC-70 (Tape and Reel) CTTR = 5-pin SOT-23 (Tape and Reel)			e) TC1017-2.8VCTTR: 150 mA, Tiny CMOS LDO with Shutdown, SOT-23 package.
				f) TC1017-2.85VLTR: 150 mA, Tiny CMOS LDO with Shutdown, SC-70 package.
				g) TC1017-2.9VCTTR: 150 mA, Tiny CMOS LDO with Shutdown, SOT-23 package.
				h) TC1017-3.0VLTR: 150 mA, Tiny CMOS LDO with Shutdown, SC-70 package.
				i) TC1017-3.3VCTTR: 150 mA, Tiny CMOS LDO with Shutdown, SOT-23 package.
				j) TC1017-4.0VLTR: 150 mA, Tiny CMOS LDO with Shutdown, SC-70 package.

# TC1017

---

NOTES:



---

---

**Note the following details of the code protection feature on Microchip devices:**

- Microchip products meet the specification contained in their particular Microchip Data Sheet.
- Microchip believes that its family of products is one of the most secure families of its kind on the market today, when used in the intended manner and under normal conditions.
- There are dishonest and possibly illegal methods used to breach the code protection feature. All of these methods, to our knowledge, require using the Microchip products in a manner outside the operating specifications contained in Microchip's Data Sheets. Most likely, the person doing so is engaged in theft of intellectual property.
- Microchip is willing to work with the customer who is concerned about the integrity of their code.
- Neither Microchip nor any other semiconductor manufacturer can guarantee the security of their code. Code protection does not mean that we are guaranteeing the product as “unbreakable.”

Code protection is constantly evolving. We at Microchip are committed to continuously improving the code protection features of our products. Attempts to break Microchip's code protection feature may be a violation of the Digital Millennium Copyright Act. If such acts allow unauthorized access to your software or other copyrighted work, you may have a right to sue for relief under that Act.

---

Information contained in this publication regarding device applications and the like is provided only for your convenience and may be superseded by updates. It is your responsibility to ensure that your application meets with your specifications. MICROCHIP MAKES NO REPRESENTATIONS OR WARRANTIES OF ANY KIND WHETHER EXPRESS OR IMPLIED, WRITTEN OR ORAL, STATUTORY OR OTHERWISE, RELATED TO THE INFORMATION, INCLUDING BUT NOT LIMITED TO ITS CONDITION, QUALITY, PERFORMANCE, MERCHANTABILITY OR FITNESS FOR PURPOSE. Microchip disclaims all liability arising from this information and its use. Use of Microchip devices in life support and/or safety applications is entirely at the buyer's risk, and the buyer agrees to defend, indemnify and hold harmless Microchip from any and all damages, claims, suits, or expenses resulting from such use. No licenses are conveyed, implicitly or otherwise, under any Microchip intellectual property rights.

#### **Trademarks**

The Microchip name and logo, the Microchip logo, dsPIC, FlashFlex, KEELOQ, KEELOQ logo, MPLAB, PIC, PICmicro, PICSTART, PIC<sup>32</sup> logo, rPIC, SST, SST Logo, SuperFlash and UNI/O are registered trademarks of Microchip Technology Incorporated in the U.S.A. and other countries.

FilterLab, Hampshire, HI-TECH C, Linear Active Thermistor, MTP, SEEVAL and The Embedded Control Solutions Company are registered trademarks of Microchip Technology Incorporated in the U.S.A.

Silicon Storage Technology is a registered trademark of Microchip Technology Inc. in other countries.

Analog-for-the-Digital Age, Application Maestro, BodyCom, chipKIT, chipKIT logo, CodeGuard, dsPICDEM, dsPICDEM.net, dsPICworks, dsSPEAK, ECAN, ECONOMONITOR, FanSense, HI-TIDE, In-Circuit Serial Programming, ICSP, Mindi, MiWi, MPASM, MPF, MPLAB Certified logo, MPLIB, MPLINK, mTouch, Omniclient Code Generation, PICC, PICC-18, PICDEM, PICDEM.net, PICkit, PICtail, REAL ICE, rLAB, Select Mode, SQI, Serial Quad I/O, Total Endurance, TSHARC, UniWinDriver, WiperLock, ZENA and Z-Scale are trademarks of Microchip Technology Incorporated in the U.S.A. and other countries.

SQTP is a service mark of Microchip Technology Incorporated in the U.S.A.

GestIC and ULPP are registered trademarks of Microchip Technology Germany II GmbH & Co. KG, a subsidiary of Microchip Technology Inc., in other countries.

All other trademarks mentioned herein are property of their respective companies.

© 2005-2013, Microchip Technology Incorporated, Printed in the U.S.A., All Rights Reserved.

 Printed on recycled paper.

ISBN: 9781620771440

**QUALITY MANAGEMENT SYSTEM**  
**CERTIFIED BY DNV**  
**== ISO/TS 16949 ==**

*Microchip received ISO/TS-16949:2009 certification for its worldwide headquarters, design and wafer fabrication facilities in Chandler and Tempe, Arizona; Gresham, Oregon and design centers in California and India. The Company's quality system processes and procedures are for its PIC® MCUs and dsPIC® DSCs, KEELOQ® code hopping devices, Serial EEPROMs, microperipherals, nonvolatile memory and analog products. In addition, Microchip's quality system for the design and manufacture of development systems is ISO 9001:2000 certified.*



# MICROCHIP

## Worldwide Sales and Service

### AMERICAS

**Corporate Office**  
2355 West Chandler Blvd.  
Chandler, AZ 85224-6199  
Tel: 480-792-7200  
Fax: 480-792-7277  
Technical Support:  
<http://www.microchip.com/support>  
Web Address:  
[www.microchip.com](http://www.microchip.com)

**Atlanta**  
Duluth, GA  
Tel: 678-957-9614  
Fax: 678-957-1455

**Boston**  
Westborough, MA  
Tel: 774-760-0087  
Fax: 774-760-0088

**Chicago**  
Itasca, IL  
Tel: 630-285-0071  
Fax: 630-285-0075

**Cleveland**  
Independence, OH  
Tel: 216-447-0464  
Fax: 216-447-0643

**Dallas**  
Addison, TX  
Tel: 972-818-7423  
Fax: 972-818-2924

**Detroit**  
Farmington Hills, MI  
Tel: 248-538-2250  
Fax: 248-538-2260

**Indianapolis**  
Noblesville, IN  
Tel: 317-773-8323  
Fax: 317-773-5453

**Los Angeles**  
Mission Viejo, CA  
Tel: 949-462-9523  
Fax: 949-462-9608

**Santa Clara**  
Santa Clara, CA  
Tel: 408-961-6444  
Fax: 408-961-6445

**Toronto**  
Mississauga, Ontario,  
Canada  
Tel: 905-673-0699  
Fax: 905-673-6509

### ASIA/PACIFIC

**Asia Pacific Office**  
Suites 3707-14, 37th Floor  
Tower 6, The Gateway  
Harbour City, Kowloon  
Hong Kong  
Tel: 852-2401-1200  
Fax: 852-2401-3431

**Australia - Sydney**  
Tel: 61-2-9868-6733  
Fax: 61-2-9868-6755

**China - Beijing**  
Tel: 86-10-8569-7000  
Fax: 86-10-8528-2104

**China - Chengdu**  
Tel: 86-28-8665-5511  
Fax: 86-28-8665-7889

**China - Chongqing**  
Tel: 86-23-8980-9588  
Fax: 86-23-8980-9500

**China - Hangzhou**  
Tel: 86-571-2819-3187  
Fax: 86-571-2819-3189

**China - Hong Kong SAR**  
Tel: 852-2943-5100  
Fax: 852-2401-3431

**China - Nanjing**  
Tel: 86-25-8473-2460  
Fax: 86-25-8473-2470

**China - Qingdao**  
Tel: 86-532-8502-7355  
Fax: 86-532-8502-7205

**China - Shanghai**  
Tel: 86-21-5407-5533  
Fax: 86-21-5407-5066

**China - Shenyang**  
Tel: 86-24-2334-2829  
Fax: 86-24-2334-2393

**China - Shenzhen**  
Tel: 86-755-8864-2200  
Fax: 86-755-8203-1760

**China - Wuhan**  
Tel: 86-27-5980-5300  
Fax: 86-27-5980-5118

**China - Xian**  
Tel: 86-29-8833-7252  
Fax: 86-29-8833-7256

**China - Xiamen**  
Tel: 86-592-2388138  
Fax: 86-592-2388130

**China - Zhuhai**  
Tel: 86-756-3210040  
Fax: 86-756-3210049

### ASIA/PACIFIC

**India - Bangalore**  
Tel: 91-80-3090-4444  
Fax: 91-80-3090-4123

**India - New Delhi**  
Tel: 91-11-4160-8631  
Fax: 91-11-4160-8632

**India - Pune**  
Tel: 91-20-2566-1512  
Fax: 91-20-2566-1513

**Japan - Osaka**  
Tel: 81-6-6152-7160  
Fax: 81-6-6152-9310

**Japan - Tokyo**  
Tel: 81-3-6880-3770  
Fax: 81-3-6880-3771

**Korea - Daegu**  
Tel: 82-53-744-4301  
Fax: 82-53-744-4302

**Korea - Seoul**  
Tel: 82-2-554-7200  
Fax: 82-2-558-5932 or  
82-2-558-5934

**Malaysia - Kuala Lumpur**  
Tel: 60-3-6201-9857  
Fax: 60-3-6201-9859

**Malaysia - Penang**  
Tel: 60-4-227-8870  
Fax: 60-4-227-4068

**Philippines - Manila**  
Tel: 63-2-634-9065  
Fax: 63-2-634-9069

**Singapore**  
Tel: 65-6334-8870  
Fax: 65-6334-8850

**Taiwan - Hsin Chu**  
Tel: 886-3-5778-366  
Fax: 886-3-5770-955

**Taiwan - Kaohsiung**  
Tel: 886-7-213-7828  
Fax: 886-7-330-9305

**Taiwan - Taipei**  
Tel: 886-2-2508-8600  
Fax: 886-2-2508-0102

**Thailand - Bangkok**  
Tel: 66-2-694-1351  
Fax: 66-2-694-1350

### EUROPE

**Austria - Wels**  
Tel: 43-7242-2244-39  
Fax: 43-7242-2244-393

**Denmark - Copenhagen**  
Tel: 45-4450-2828  
Fax: 45-4485-2829

**France - Paris**  
Tel: 33-1-69-53-63-20  
Fax: 33-1-69-30-90-79

**Germany - Munich**  
Tel: 49-89-627-144-0  
Fax: 49-89-627-144-44

**Italy - Milan**  
Tel: 39-0331-742611  
Fax: 39-0331-466781

**Netherlands - Drunen**  
Tel: 31-416-690399  
Fax: 31-416-690340

**Spain - Madrid**  
Tel: 34-91-708-08-90  
Fax: 34-91-708-08-91

**UK - Wokingham**  
Tel: 44-118-921-5869  
Fax: 44-118-921-5820

11/29/12