

### Features

- ◆ The plastic package carries Underwriters Laboratory Flammability Classification 94V-0
- ◆ For surface mounted applications
- ◆ Metal silicon junction, majority carrier conduction
- ◆ Low power loss, high efficiency
- ◆ Built-in strain relief, ideal for automated placement
- ◆ High forward surge current capability
- ◆ High temperature soldering guaranteed: 260°C/10 seconds at terminals
- ◆ Compliant to RoHS 2.0
- ◆ Suffix "-H" indicates Halogen-free part, ex. SS54B-H

### Mechanical data

- ◆ **Case:** JEDEC DO-214AA molded plastic body
- ◆ **Terminals:** Solder plated, solderable per MIL-STD-750, Method 2026
- ◆ **Polarity:** Color band denotes cathode end
- ◆ **Mounting Position:** Any

### Package outline

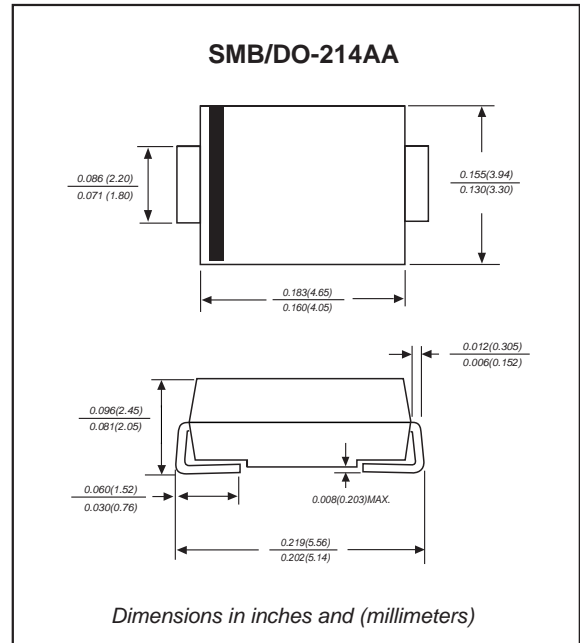

### Maximum ratings and Electrical Characteristics (AT $T_A=25^\circ\text{C}$ unless otherwise noted)



PARAMETER	SYMBOLS	SS52B	SS53B	SS54B	SS55B	SS56B	SS58B	SS510B	SS515B	SS520B	UNITS
Maximum repetitive peak reverse voltage	$V_{RRM}$	20	30	40	50	60	80	100	150	200	V
Maximum RMS voltage	$V_{RMS}$	14	21	28	35	42	56	70	105	140	V
Maximum DC blocking voltage	$V_{DC}$	20	30	40	50	60	80	100	150	200	V
Maximum average forward rectified current at $T_L$ (see fig.1)	$I_{(AV)}$	5.0									A
Peak forward surge current 8.3ms single half sine-wave superimposed on rated load	$I_{FSM}$	150.0									A
Maximum instantaneous forward voltage at 5.0A	$V_F$	0.55			0.70		0.85		0.95		V
Maximum DC reverse current at rated DC blocking voltage	$I_R$	0.5			10.0		5.0		2.0		mA
Typical junction capacitance (NOTE 1)	$C_J$	500									pF
Typical thermal resistance (NOTE 2)	$R_{\theta JA}$	50									$^\circ\text{C/W}$
Operating junction temperature range	$T_J$	-55 to +125			-55 to +150						$^\circ\text{C}$
Storage temperature range	$T_{STG}$	-55 to +150									$^\circ\text{C}$

**Note:** 1. Measured at 1MHz and applied reverse voltage of 4.0V D.C.  
 2. P.C.B. mounted with 2.0x2.0" (5.0x5.0cm) copper pad areas

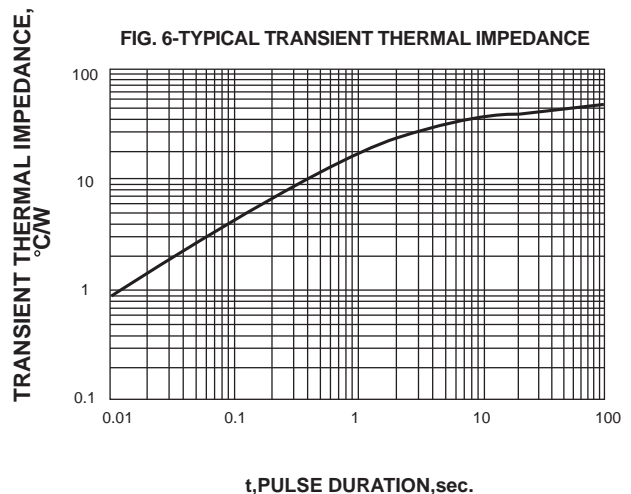
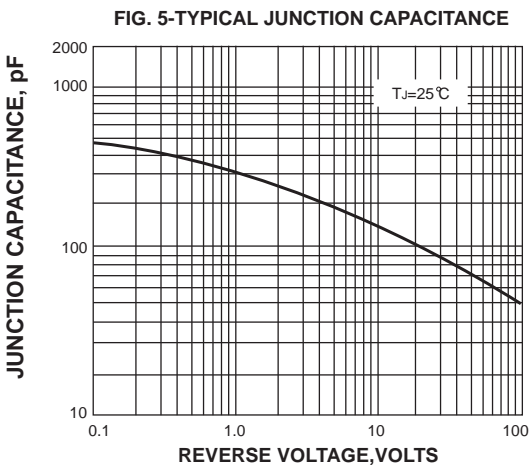
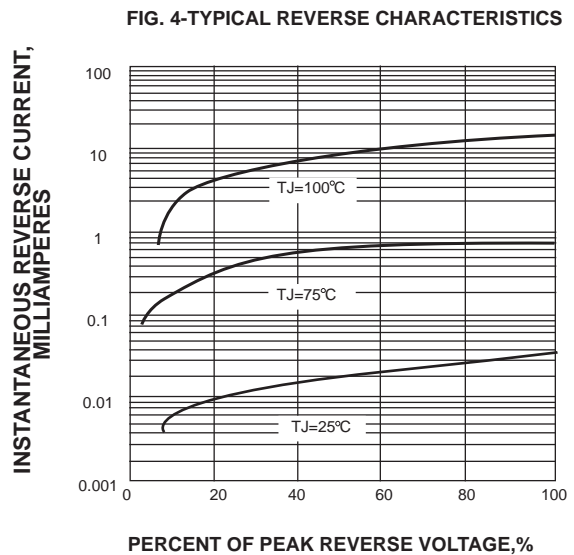
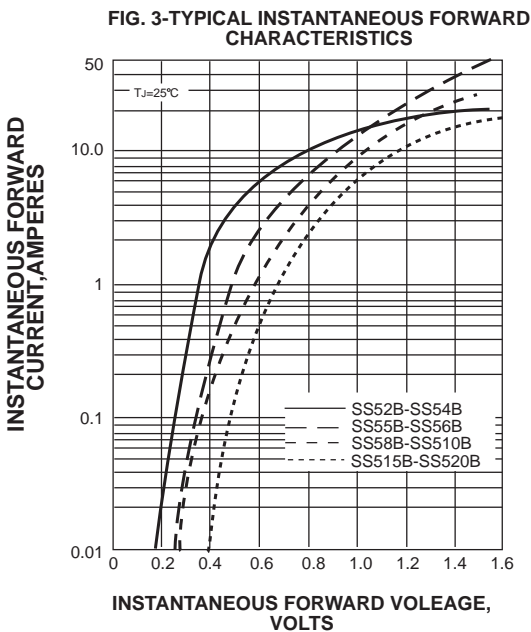
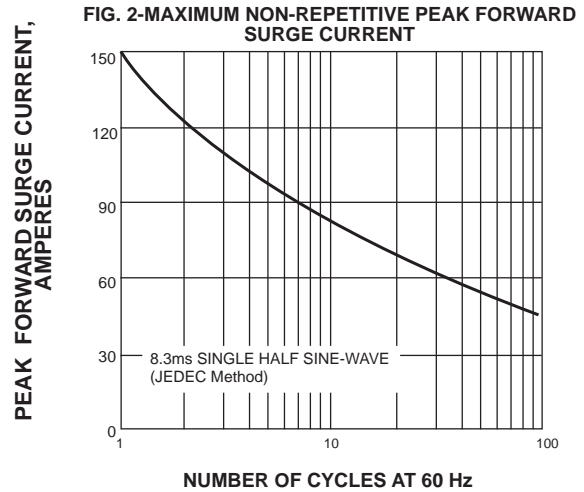
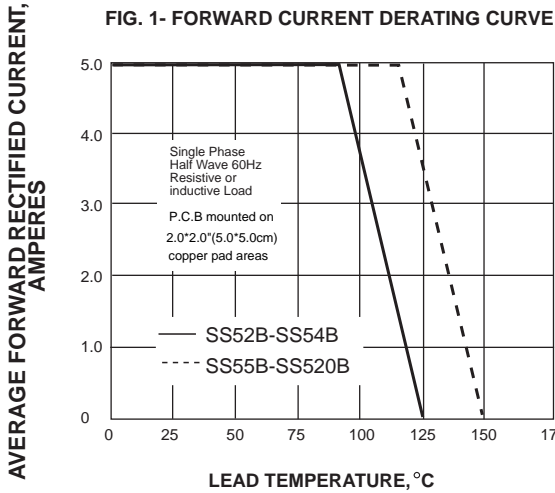
### Rating and characteristic curves

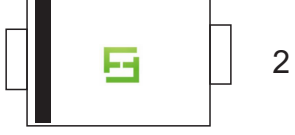

## Pinning information

Pin	Simplified outline	Symbol
Pin1 cathode Pin2 anode		

## Marking

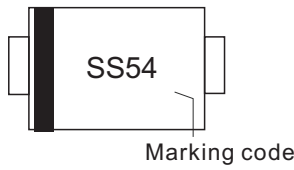
Type number	Marking code	Example
SS52B	SS52	
SS53B	SS53	
SS54B	SS54	
SS55B	SS55	
SS56B	SS56	
SS58B	SS58	
SS510B	SS510	
SS515B	SS515	
SS520B	SS520	

## Suggested solder pad layout

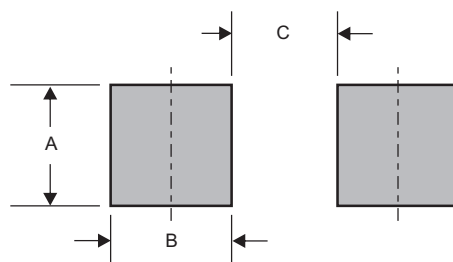

Dimensions in inches and (millimeters)

PACKAGE	A	B	C
SMB	0.078 (2.00)	0.059 (1.50)	0.110 (2.80)

**Suggested thermal profiles for soldering processes**

- 1.Storage environment: Temperature=5°C~40°C Humidity=55%±25%
- 2.Reflow soldering of surface-mount devices

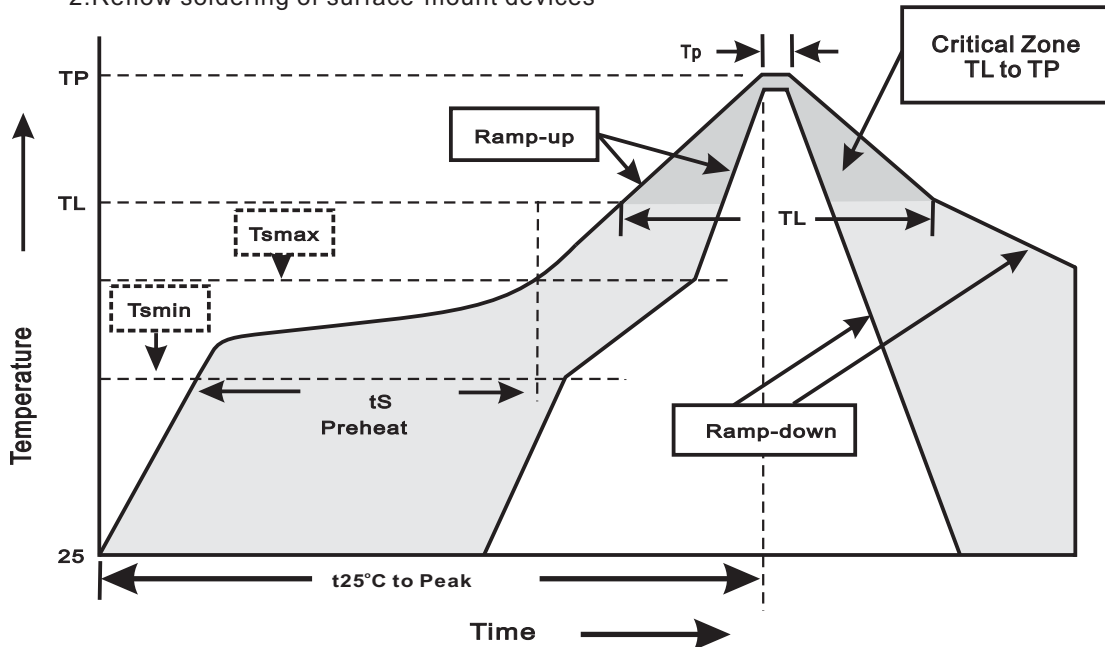

3.Reflow soldering

Profile Feature	Soldering Condition
Average ramp-up rate(TL to TP)	<3°C/sec
Preheat -Temperature Min(Tsmin) -Temperature Max(Tsmax) -Time(min to max)(ts)	150°C 200°C 60~120sec
Tsmax to TL -Ramp-upRate	<3°C/sec
Time maintained above: -Temperature(TL) -Time(tL)	217°C 60~260sec
Peak Temperature(TP)	255°C-0/+5°C
Time within 5°C of actual Peak Temperature(tp)	10~30sec
Ramp-down Rate	<6°C/sec
Time 25°C to Peak Temperature	<6minutes