



Features

- u 250 Watts Peak Pulse Power (8/20 μ s)(Vcc-GND)
- u Protects two or four I/O lines
- u Low capacitance: 0.35 pF typical (I/O to I/O)
- u Low operating voltage: 5V
- u RoHS Compliant
- u IEC61000-4-2 (ESD) \pm 25kV (air), \pm 20kV (contact)
- u IEC61000-4-4 (EFT) 40A (5/50ns)
- u IEC61000-4-5 (Lightning) 4.3A(8/20 μ s)

Mechanical Characteristics

- u Package: DFN2510-10 (2.5 \times 1.0 \times 0.5mm)
- u Ultra low leakage: nA level
- u Case Material: "Green" Molding Compound.
- u UL Flammability Classification Rating 94V-0
- u Moisture Sensitivity: Level 3 per J-STD-020
- u Terminal Connections: See Diagram Below

Applications

- u High Definition Multimedia Interface (HDMI)
- u Digital Visual Interface (DVI)
- u Unified Display Interface (UDI)
- u MDDI Ports
- u PCI Express
- u Serial ATA

Ordering Information

Part Number	Qty per Reel	Reel Size
TPESD05R4P	3000	7"

Dimensions and Pin Configuration

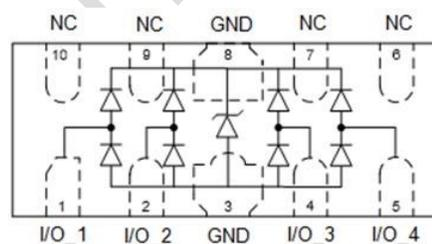

Absolute Maximum Ratings (Tamb=25°C unless otherwise specified)

Parameter	Symbol	Value	Unit
Peak Pulse Power (8/20μs) (Vcc-GND)	Ppk	250	W
ESD per IEC 61000-4-2 (Air)	VESD	± 25	kV
ESD per IEC 61000-4-2 (Contact)		± 15	
Operating Temperature Range	TJ	-55 to +125	°C
Storage Temperature Range	Tstg	-55 to +150	°C

Electrical Characteristics (TA=25°C unless otherwise specified)

Parameter	Symbol	Min	Typ	Max	Unit	Test Condition
Reverse Working Voltage	VRWM			5	V	Any I/O pin to ground
Breakdown Voltage	VBR	6.8		9.5	V	IT = 1mA, any I/O pin to ground
Reverse Leakage Current	IR			0.08	μA	VRWM = 5V, any I/O pin to ground
Clamping Voltage	VC			15	V	I _{PP} = 4.3A (8 x 20μs pulse), any I/O pin to ground
Junction Capacitance	CJ		0.35		pF	VR = 0V, f = 1MHz, between I/O pins
Junction Capacitance	CJ		0.6	0.8	pF	VR = 0V, f = 1MHz, any I/O pin to ground

Characteristic Curves

Fig1. 8/20 μ s Pulse Waveform

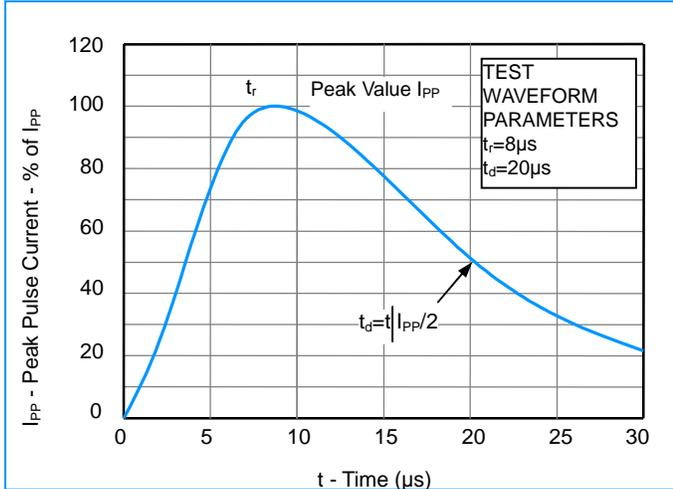

Fig2. ESD Pulse Waveform (according to IEC 61000-4-2)

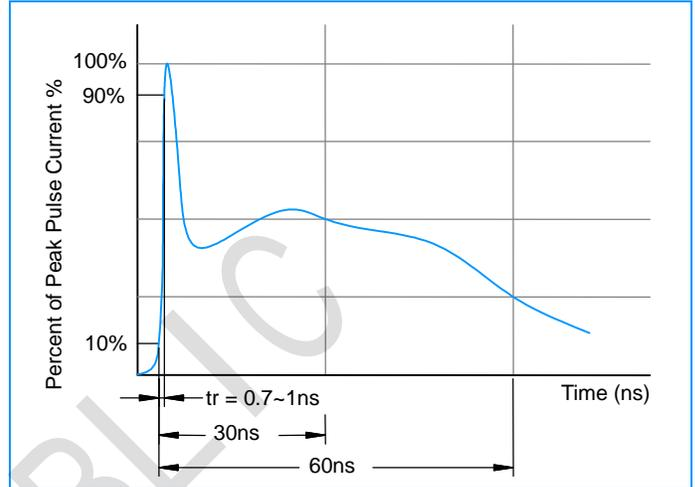
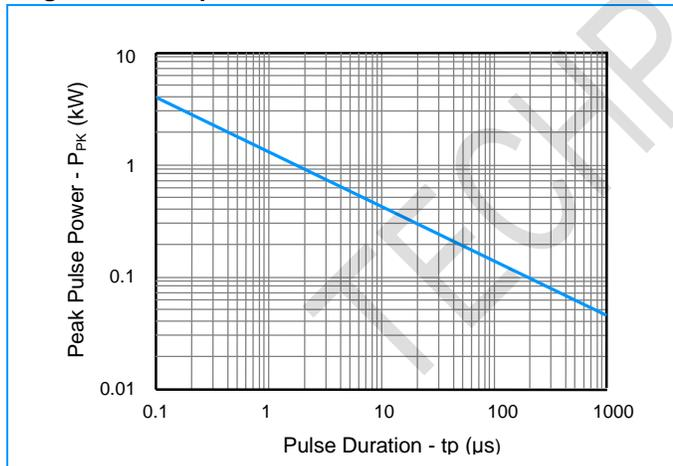
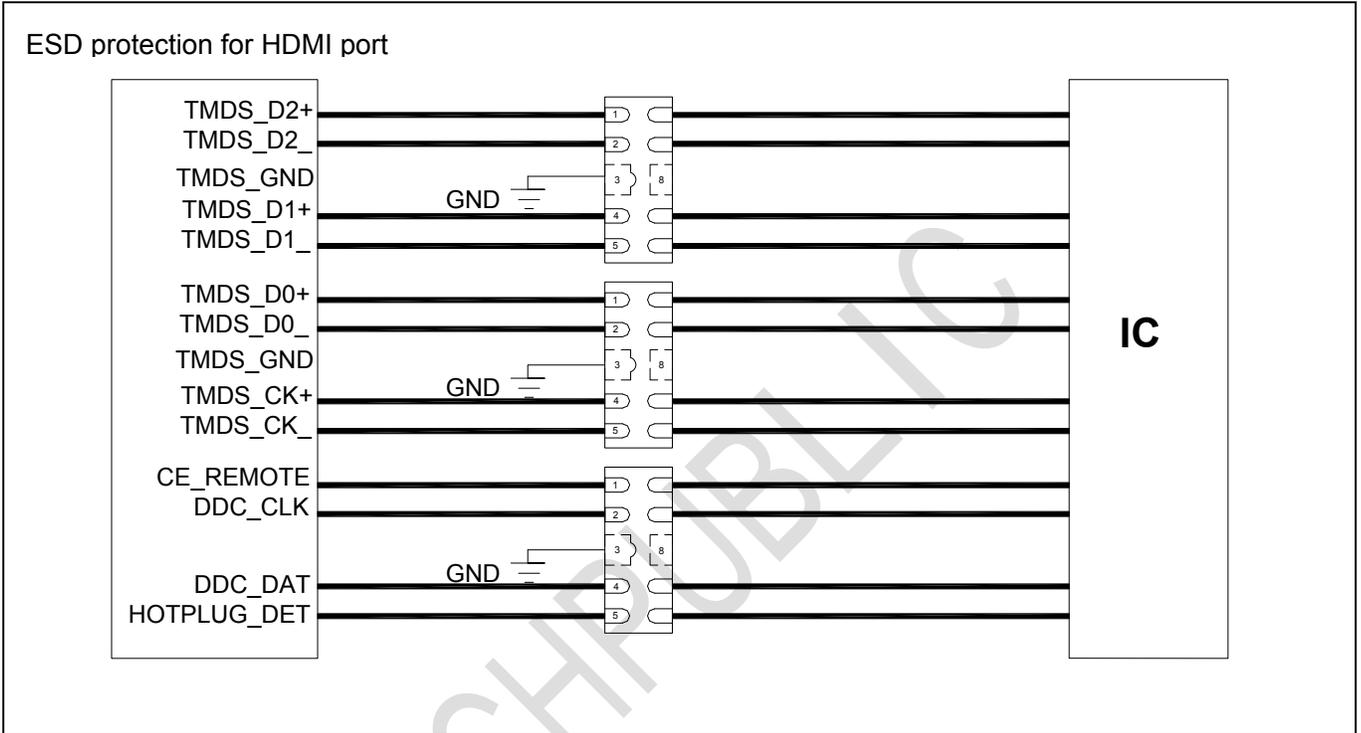

Fig3. Non - Repetitive Peak Pulse Power vs. Pulse Time



Application Information



Outline Drawing - DFN2510-10

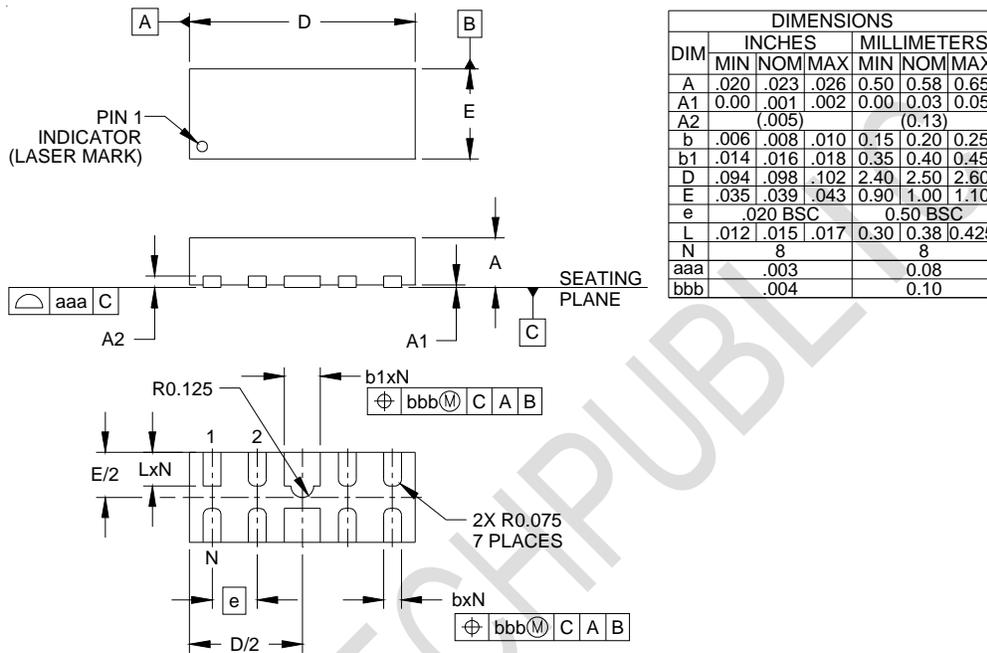

Land Pattern - DFN2510-10

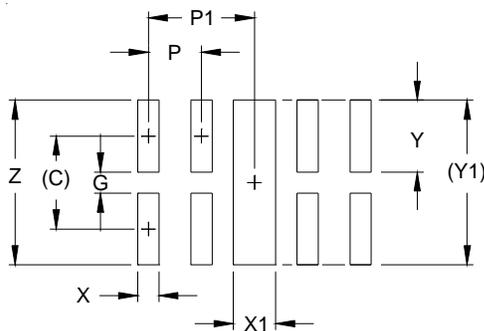

DIM	DIMENSIONS	
	INCHES	MILLIMETERS
C	(.034)	(0.875)
G	.008	0.20
P	.020	0.50
P1	.039	1.00
X	.008	0.20
X1	.016	0.40
Y	.027	0.675
Y1	(.061)	(1.55)
Z	.061	1.55