

## SOT-363 Plastic-Encapsulate MOSFETs

### CJ7252KDW N Channel + P Channel Power MOSFET

$V_{(BR)DSS}$	$R_{DS(on)MAX}$	$I_D$
60V	5Ω@10V	0.34A
	5.3Ω@4.5V	
-50V	8Ω@-10V	-0.18A
	10Ω@-5V	

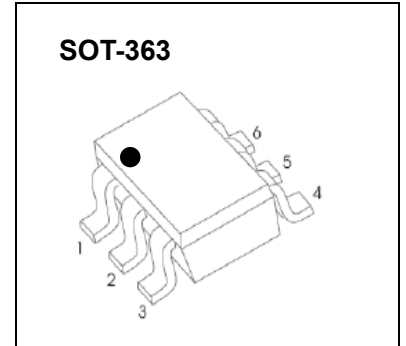

#### DESCRIPTION

This N Channel + P Channel MOSFET has been designed using advanced power trench process to optimize the  $R_{DS(ON)}$ .

#### FEATURE

- High-Side Switching
- Low Threshold
- Fast Switching Speed

#### APPLICATION

- Drivers:Relays, Solenoids, Memories
- Battery Operated Systems
- Power Supply Converter Circuits
- Load/Power Switching Cell Phones, Pagars

#### MARKING: 75

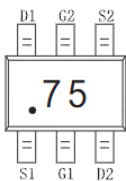

#### Equivalent Circuit

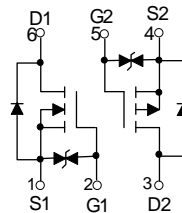

#### MAXIMUM RATINGS ( $T_a=25^{\circ}C$ unless otherwise noted)

Symbol	Parameter	Value	Unit
<b>N-Channel MOSFET</b>			
$V_{DS}$	Drain-Source Voltage	60	V
$V_{GS}$	Gate-Source Voltage	±20	V
$I_D$	Drain Current -Continuous	0.34	A
$I_{DM}$	Drain Current - Pulsed(Note1)	1.36	A
<b>P- Channel MOSFET</b>			
$V_{DS}$	Drain-Source Voltage	-50	V
$V_{GS}$	Gate-Source Voltage	±20	V
$I_D$	Drain Current -Continuous	-0.18	A
$I_{DM}$	Drain Current – Pulsed (Note1)	-0.7	A
<b>Power Dissipation, Temperature and Thermal Resistance</b>			
$P_D$	Power Dissipation	0.15	W
$R_{\theta JA}$	Thermal Resistance from Junction to Ambient (Note2)	833	°C/W
$T_j$	Junction Temperature	150	°C
$T_{stg}$	Storage Temperature	-55~+150	°C
$T_L$	Lead Temperature	260	°C

# MOSFET ELECTRICAL CHARACTERISTICS

$T_a=25^\circ\text{C}$  unless otherwise specified

Parameter	Symbol	Test conditions	Min	Typ	Max	Unit
<b>N- Channel MOSFET</b>						
Drain-source breakdown voltage	$V_{(BR)DSS}$	$V_{GS}=0V, I_D=250\mu A$	60			V
Zero gate voltage drain current	$I_{DSS}$	$V_{DS}=48V, V_{GS}=0V$			1	$\mu A$
Gate-body leakage current	$I_{GSS}$	$V_{GS}=\pm 20V, V_{DS}=0V$			$\pm 10$	$\mu A$
		$V_{GS}=\pm 10V, V_{DS}=0V$			$\pm 200$	nA
		$V_{GS}=\pm 5V, V_{DS}=0V$			$\pm 100$	nA
Gate threshold voltage (note 3)	$V_{GS(th)}$	$V_{DS}=V_{GS}, I_D=1mA$	1	1.3	2.5	V
Drain-source on-resistance (note 3)	$R_{DS(on)}$	$V_{GS}=4.5V, I_D=0.2A$		1.1	5.3	$\Omega$
		$V_{GS}=10V, I_D=0.5A$		0.9	5	$\Omega$
Diode forward voltage	$V_{SD}$	$I_S=0.3A, V_{GS}=0V$			1.5	V
<b>DYNAMIC PARAMETERS (note 4)</b>						
Input Capacitance	$C_{iss}$	$V_{DS}=10V, V_{GS}=0V, f=1MHz$			40	pF
Output Capacitance	$C_{oss}$				30	pF
Reverse Transfer Capacitance	$C_{rss}$				10	pF
<b>SWITCHING PARAMETERS (note 4)</b>						
Turn-on delay time	$t_{d(on)}$	$V_{GS}=10V, V_{DD}=50V,$			10	ns
Turn-off delay time	$t_{d(off)}$	$R_L=250\Omega, R_{GEN}=50\Omega,$			15	ns
Reverse recovery time	$t_{rr}$	$I_S=300mA;$		30		ns
Recovered charge	$Q_r$	$d_{IS}/d_t=-100A/s; V_{GS}=0V;$ $V_R=25V$		30		nC
<b>P- Channel MOSFET</b>						
Drain-source breakdown voltage	$V_{(BR)DSS}$	$V_{GS}=0V, I_D=-250\mu A$	-50			V
Zero gate voltage drain current	$I_{DSS}$	$V_{DS}=-50V, V_{GS}=0V$			-15	$\mu A$
		$V_{DS}=-25V, V_{GS}=0V$			-0.1	$\mu A$
Gate-body leakage current	$I_{GSS}$	$V_{GS}=\pm 20V, V_{DS}=0V$			$\pm 10$	nA
Gate threshold voltage (note 3)	$V_{GS(th)}$	$V_{DS}=V_{GS}, I_D=-250\mu A$	-0.9	-1.62	-2	V
Drain-source on-resistance (note 3)	$R_{DS(on)}$	$V_{GS}=-5V, I_D=-0.1A$		5.5	10	$\Omega$
		$V_{GS}=-10V, I_D=-0.1A$		4.1	8	$\Omega$
Forward transconductance (note 3)	$g_{FS}$	$V_{DS}=-25V, I_D=-0.1A$	0.05			S
<b>DYNAMIC CHARACTERISTICS (note 4)</b>						
Input capacitance	$C_{iss}$	$V_{DS}=-5V, V_{GS}=0V, f=1MHz$		30		pF
Output capacitance	$C_{oss}$			10		pF
Reverse transfer capacitance	$C_{rss}$			5		pF
<b>SWITCHING CHARACTERISTICS (note 4)</b>						
Turn-on delay time	$t_{d(on)}$	$V_{DD}=-15V,$ $R_L=50\Omega, I_D=-2.5A$		2.5		ns
Turn-on rise time	$t_r$			1		ns
Turn-off delay time	$t_{d(off)}$			16		ns
Turn-off fall time	$t_f$			8		ns
<b>SOURCE-DRAIN DIODE CHARACTERISTICS (note 4)</b>						
Continuous Current	$I_S$				-0.18	A
Pulsed Current	$I_{SM}$				-0.7	A
Diode forward voltage (note 3)	$V_{DS}$	$I_S=-0.13A, V_{GS}=0V$			-2.2	V

- Note:**
- 1、 Surface mounted on FR-4 board using minimum pad size, 1oz copper
  - 2、 Repetitive Rating: Pulse width limited by maximum junction temperature.
  - 3、 Pulse test: pulse width  $\leq 300\mu s$ , duty cycle  $\leq 2\%$
  - 4、 These parameters have no way to verify.

# Typical Characteristics

## N-Channel MOS

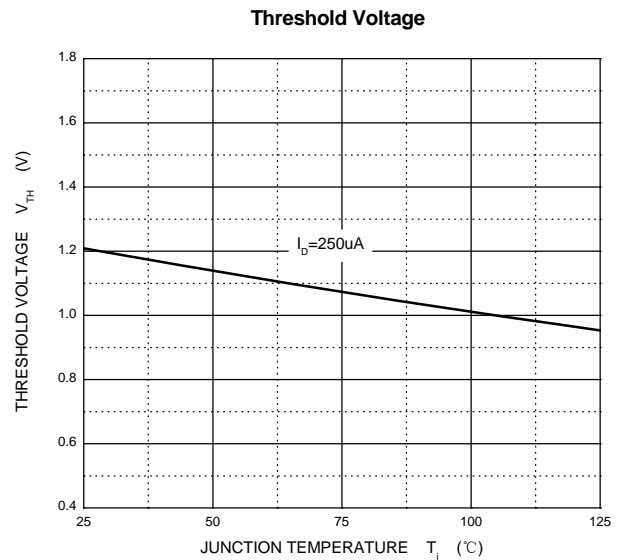
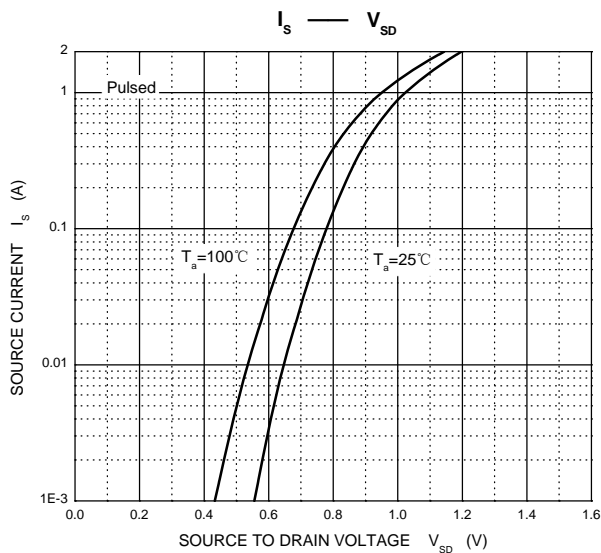
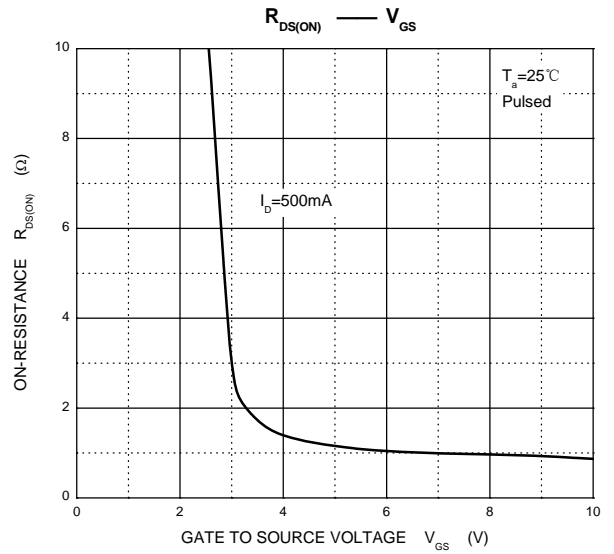
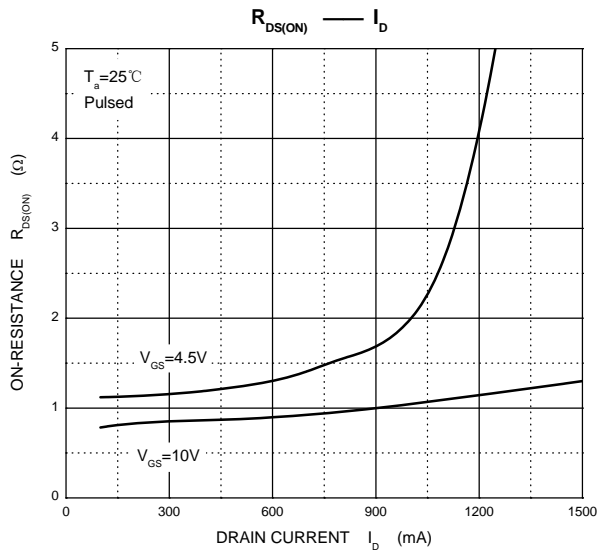
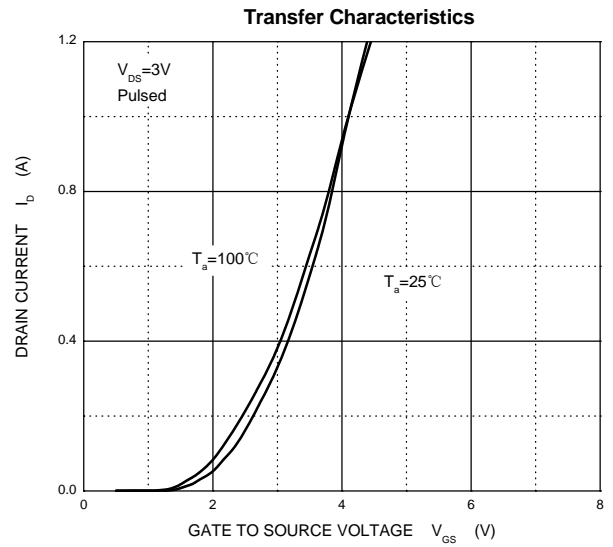
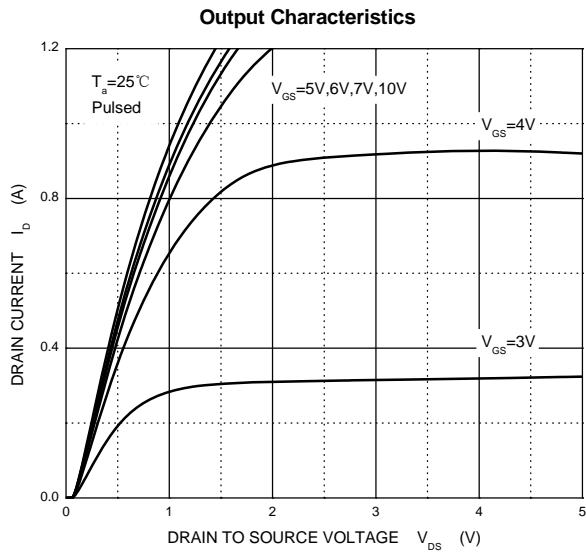

# Typical Characteristics

P-Channel MOS

Output Characteristics

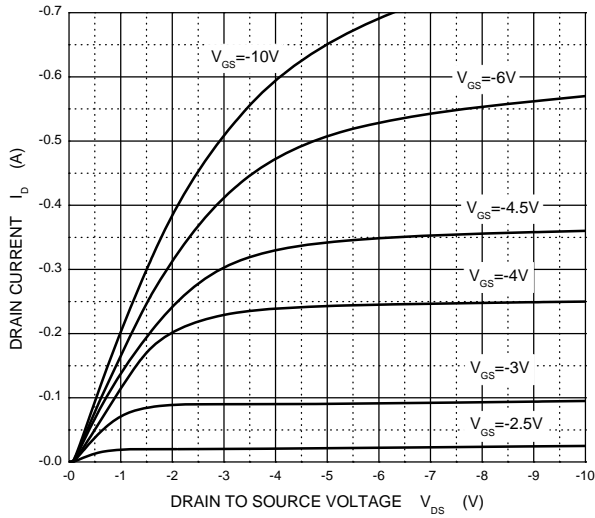

Transfer Characteristics

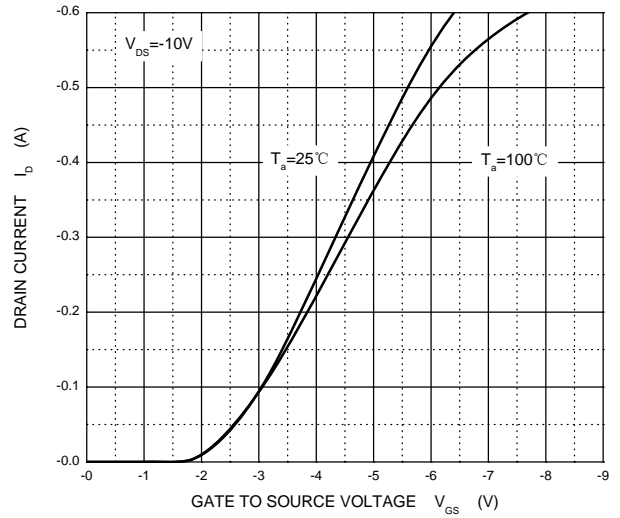

$R_{DS(ON)}$  —  $I_D$

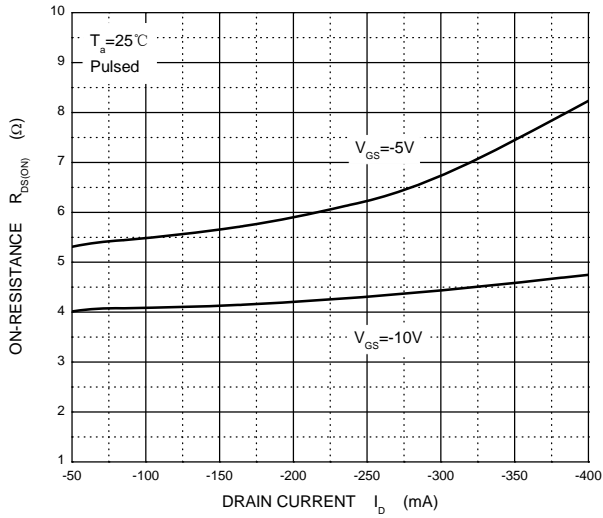

$R_{DS(ON)}$  —  $V_{GS}$

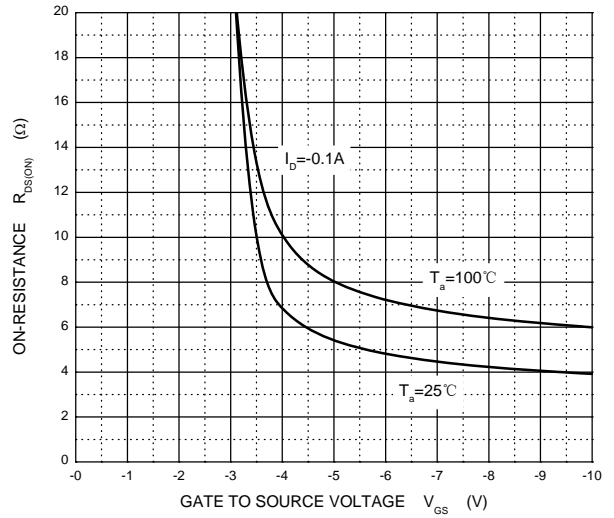

$I_S$  —  $V_{SD}$

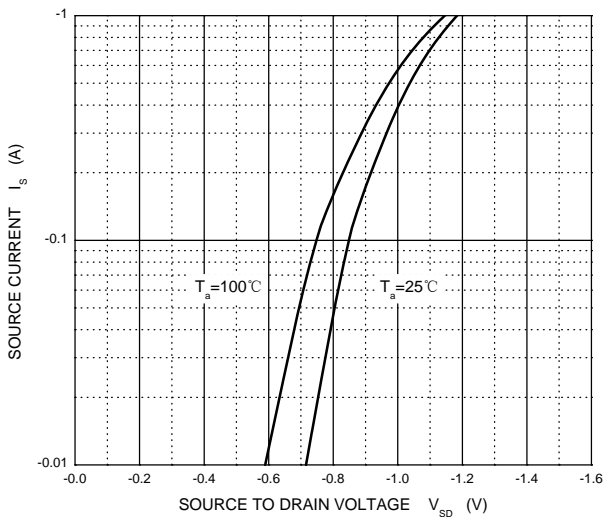

Threshold Voltage

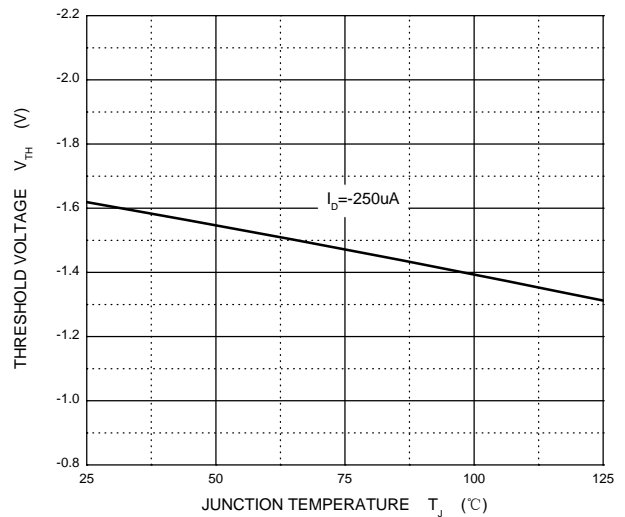

## SOT-363 Package Outline Dimensions

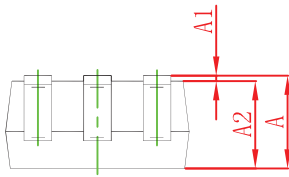
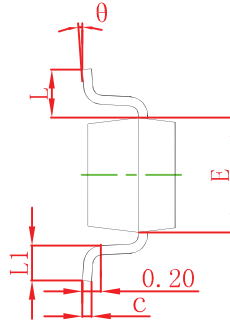
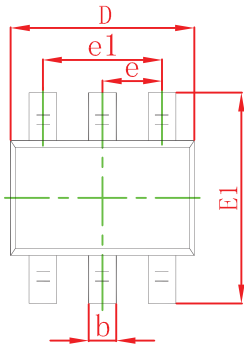

Symbol	Dimensions In Millimeters		Dimensions In Inches	
	Min	Max	Min	Max
A	0.900	1.100	0.035	0.043
A1	0.000	0.100	0.000	0.004
A2	0.900	1.000	0.035	0.039
b	0.150	0.350	0.006	0.014
c	0.100	0.150	0.004	0.006
D	2.000	2.200	0.079	0.087
E	1.150	1.350	0.045	0.053
E1	2.150	2.400	0.085	0.094
e	0.650 TYP		0.026 TYP	
e1	1.200	1.400	0.047	0.055
L	0.525 REF		0.021 REF	
L1	0.260	0.460	0.010	0.018
theta	0°	8°	0°	8°

## SOT-363 Suggested Pad Layout

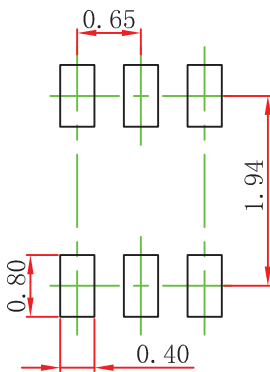

### Note:

1. Controlling dimension: in millimeters.
2. General tolerance:  $\pm 0.05\text{mm}$ .
3. The pad layout is for reference purposes only.

### NOTICE

JSCJ reserves the right to make modifications, enhancements, improvements, corrections or other changes without further notice to any product herein. JSCJ does not assume any liability arising out of the application or use of any product described herein.

# SOT-363 Tape and Reel

## SOT-363 Embossed Carrier Tape

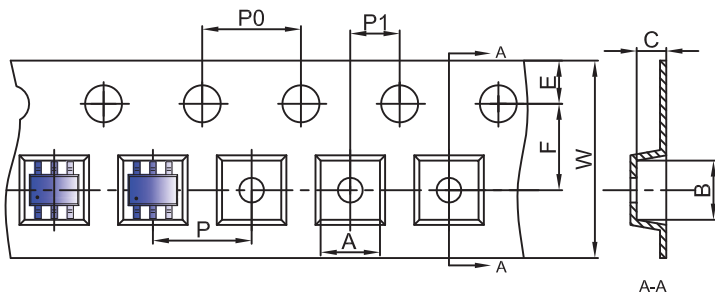

### Packaging Description:

SOT-363 parts are shipped in tape. The carrier tape is made from a dissipative (carbon filled) polycarbonate resin. The cover tape is a multilayer film (Heat Activated Adhesive in nature) primarily composed of polyester film, adhesive layer, sealant, and anti-static sprayed agent. These reeled parts in standard option are shipped with 3,000 units per 7" or 17.8cm diameter reel. The reels are clear in color and is made of polystyrene plastic (anti-static coated).

Dimensions are in millimeter										
Pkg type	A	B	C	d	E	F	P0	P	P1	W
SOT-363	2.25	2.55	1.20	Ø1.50	1.75	3.50	4.00	4.00	2.00	8.00

## SOT-363 Tape Leader and Trailer

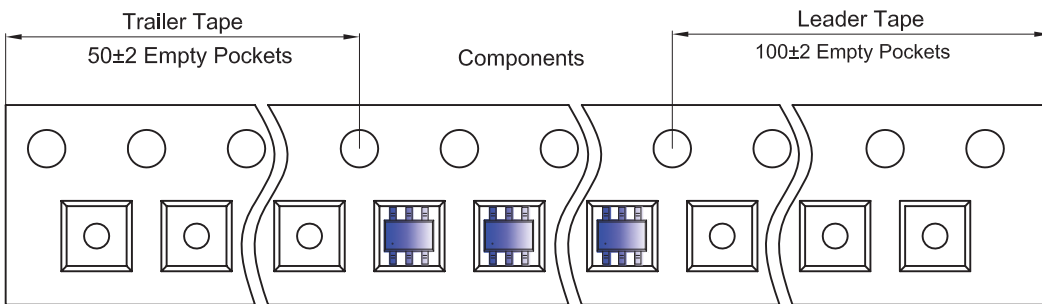

## SOT-363 Reel

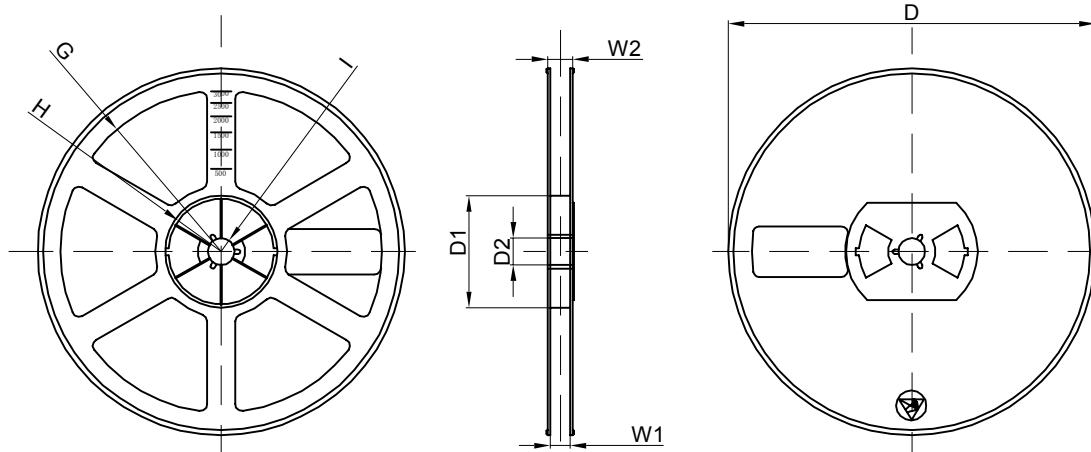

Dimensions are in millimeter								
Reel Option	D	D1	D2	G	H	I	W1	W2
7"Dia	Ø178.00	54.40	13.00	R78.00	R25.60	R6.50	9.50	12.30

REEL	Reel Size	Box	Box Size(mm)	Carton	Carton Size(mm)	G.W.(kg)
3000 pcs	7 inch	45,000 pcs	203×203×195	180,000 pcs	438×438×220	