

## SMD Molding Power Inductor

### ◆ Features

- 1、Magnetically shielded construction, low DC resistance;
- 2、The use of magnetic iron powder ensure capability for large current;
- 3、Low audible core noise;
- 4、Ideal for DC-DC converter applications in hand held personal computer and etc;
- 5、Frequency Range: up to 3.0MHz;
- 6、RoHS compliant.

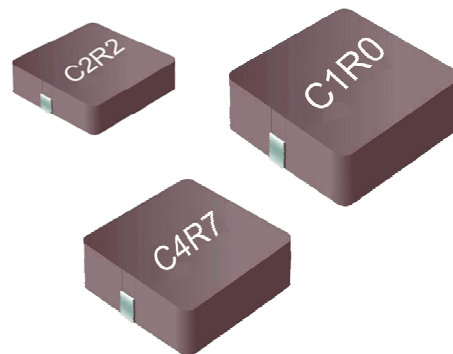

### ◆ Applications

- 1、Smart phone、MID;
- 2、Next-generation mobile devices with multifunction such as adding color TV and digital movie cameras;
- 3、Flat-screen TVs, blue-ray disc recorders, set top box;
- 4、Notebooks, desktop computers, servers, graphic cards;
- 5、Portable gaming devices, personal navigation systems, personal multimedia devices;
- 6、Automotive systems;
- 7、Telecomm base stations.

### ◆ Lead Free Part Numbering

**SLO 1050 H 100 M T T**  
**(1) (2) (3) (4) (5) (6) (7)**

- (1) Series Type
- (2) Dimension: A X C
- (3) Material Code
- (4) Inductance: 2R2=2.2 $\mu$ H ;  
100=10 $\mu$ H; 101=100 $\mu$ H
- (5) Inductance Tolerance: M=±20%, Y=±30%
- (6) Company Code
- (7) Packaging : packed in embossed carrier tape

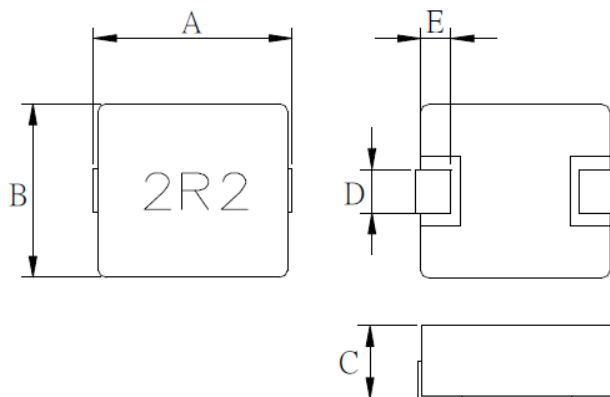

### ◆ Dimensions

| Series          | A±0.2(mm) | B±0.2 (mm) | C (mm)  | D±0.1 (mm) | E±0.1 (mm) |
|-----------------|-----------|------------|---------|------------|------------|
| <b>SLO1050H</b> | 11.15     | 10.0       | 5.0 Max | 3.0        | 2.0        |

## ◆ Specification

| Part Number            | INDUCTANCE<br>Lo( $\mu$ H) | Rdc<br>(m $\Omega$ ) | Test a<br>condition | SATURATION<br>CURRENT(Isat)<br>DC AMPS2<br>(Typ.) | HEAT RATING<br>CURRENT(Idc)<br>DC AMPS1<br>(Typ.) |
|------------------------|----------------------------|----------------------|---------------------|---|---|
|                        |                            | Max                  |                     |   |   |
| <b>SLO1050H Series</b> |                            |                      |                     |   |   |
| SLO1050HR22MTT         | 0.22                       | 0.7                  | 100KHz/1V           | 65  | 42  |
| SLO1050H1R0MTT         | 1.0                        | 3.0                  | 100KHz/1V           | 30  | 24  |
| SLO1050H1R5MTT         | 1.5                        | 3.8                  | 100KHz/1V           | 25  | 21  |
| SLO1050H2R2MTT         | 2.2                        | 6.0                  | 100KHz/1V           | 19  | 15  |
| SLO1050H3R3MTT         | 3.3                        | 10                   | 100KHz/1V           | 16  | 13  |
| SLO1050H4R7MTT         | 4.7                        | 14                   | 100KHz/1V           | 15  | 11  |
| SLO1050H5R6MTT         | 5.6                        | 17                   | 100KHz/1V           | 14  | 9.5   |
| SLO1050H6R8MTT         | 6.8                        | 18.5                 | 100KHz/1V           | 14  | 9.0   |
| SLO1050H100MTT         | 10                         | 28                   | 100KHz/1V           | 10  | 8.0   |
| SLO1050H150MTT         | 15                         | 42                   | 100KHz/1V           | 7.5   | 6.5   |
| SLO1050H220MTT         | 22                         | 50                   | 100KHz/1V           | 6.0   | 5.5   |
| SLO1050H330MTT         | 33                         | 86                   | 100KHz/1V           | 5.2   | 4.8   |
| SLO1050H470MTT         | 47                         | 127                  | 100KHz/1V           | 4.5   | 3.7   |
| SLO1050H101MTT         | 100                        | 290                  | 100KHz/1V           | 2.8   | 2.1   |

### NOTES:

1. DC current (Idc) that will cause an approximate  $\Delta T$  of 40°C
2. DC current (Isat) that will cause Lo to drop approximately 20%
3. All test data is referenced to 25°C ambient
4. Operating Temperature Range -55°C to +150°C
5. The part temperature (ambient + temp rise) should not exceed 150°C under the worst operating conditions. Circuit design, component placement, PWB trace size and thickness, airflow and other cooling provisions all affect the part temperature. Part temperature should be verified in the end application.

| Item                            | Specification and Requirement  | Test Method   |            |         |                 |       |                 |                      |      |                                 |
|---------------------------------|--|---|------------|---------|-----------------|-------|-----------------|----------------------|------|---------------------------------|
| <b>Solderability</b>            | 1. No case deformation or change in appearance<br>2. New solder coverage More than 90% | 1.Preheat: 155°C±5°C , 60S±2S<br>2.Tin: lead-free.<br>3.Temperature:245°C±5°C , flux 3.0S±0.5S.   |            |         |                 |       |                 |                      |      |                                 |
| <b>Mechanical shock</b>         | 1. No case deformation or change in appearance<br>2. $\Delta L/Lo \cong \pm 10\%$      | 1. Acceleration: 100G<br>2. Pulse time: 6ms<br>3. 3 times in each positive and negative direction of 3 mutual perpendicular directions  |            |         |                 |       |                 |                      |      |                                 |
| <b>Mechanical vibration</b>     | 1. No case deformation or change in appearance<br>2. $\Delta L/Lo \cong \pm 10\%$      | 1. The test samples shall be soldered to the board. Then it shall be submitted to below test conditions. <table border="1" data-bbox="885 795 1484 963"> <tr> <td>Fre. Range</td> <td>10~55Hz</td> </tr> <tr> <td>Total Amplitude</td> <td>1.5mm</td> </tr> <tr> <td>Sweeping Method</td> <td>10Hz to 55Hz to 10Hz</td> </tr> <tr> <td>Time</td> <td>For 2 hours on each X,Y,Z axis.</td> </tr> </table> 2. Recovery: At least 2 hours of recovery under the standard condition after the test, followed by the measurement within 24 ±2 hours. | Fre. Range | 10~55Hz | Total Amplitude | 1.5mm | Sweeping Method | 10Hz to 55Hz to 10Hz | Time | For 2 hours on each X,Y,Z axis. |
| Fre. Range                      | 10~55Hz  |   |            |         |                 |       |                 |                      |      |                                 |
| Total Amplitude                 | 1.5mm  |   |            |         |                 |       |                 |                      |      |                                 |
| Sweeping Method                 | 10Hz to 55Hz to 10Hz   |   |            |         |                 |       |                 |                      |      |                                 |
| Time                            | For 2 hours on each X,Y,Z axis.  |   |            |         |                 |       |                 |                      |      |                                 |
| <b>Thermal Shock</b>            | Inductance change:<br>Within ± 10% Without distinct damage in appearance               | 1. First -55°C for 30 minutes, last 125°C for 30 minutes as 1 cycle. Go through 1000 cycles.<br>2. Max transfer time is 2 minutes.<br>3. Measured at room temperature after placing for 24±2 hours  |            |         |                 |       |                 |                      |      |                                 |
| <b>Humidity Resistance</b>      | Inductance change:<br>Within ± 10% Without distinct damage in appearance               | 1.Reflow 2 times,<br>2.85°C,85%RH,1000 hours<br>3.Measured at room temperature after placing for 24±2 hours   |            |         |                 |       |                 |                      |      |                                 |
| <b>Low temperature storage</b>  | Inductance change:<br>Within ± 10% Without distinct damage in appearance               | 1. Temperature: -55 ± 2°C<br>2. Time: 1000 hours<br>3. Measured at room temperature after placing for 24±2 hours  |            |         |                 |       |                 |                      |      |                                 |
| <b>High temperature storage</b> | Inductance change:<br>Within ± 10% Without distinct damage in appearance               | 1. Temperature: +125 ± 2°C<br>2. Time: 1000 hours<br>3. Measured at room temperature after placing for 24±2 hours   |            |         |                 |       |                 |                      |      |                                 |

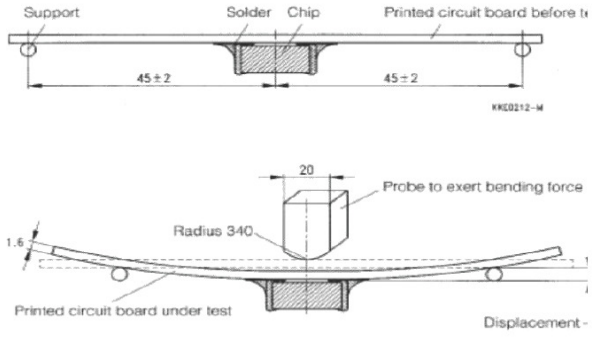
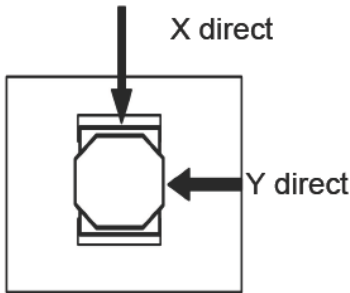
|  |  |   |
|--|--|---|
| <p align="center"><b>Board Flex</b></p>        | <p>Inductance change:<br/>Within <math>\pm 10\%</math> Without distinct damage in appearance</p> | <ol style="list-style-type: none"> <li>1、 Run through IR reflow for 2 times;</li> <li>2、 Place the 100mm X 40mm board into a fixture similar to the one shown in below Figure with the component facing down</li> <li>3、 The apparatus shall consist of mechanical means to apply a force which will bend the board (D) x = 2 mm minimum.</li> <li>4、 The duration of the applied forces shall be 60<math>\pm</math>5 sec. The force is to be applied only once to the board.</li> </ol>  |
| <p align="center"><b>Terminal Strength</b></p> | <p>No removal or split of the termination or other defects shall occur.</p>                      | <ol style="list-style-type: none"> <li>1、 The test samples shall be soldered to the board</li> <li>2、 Push the product vertically from the side of the sample using the thrust tester.</li> <li>3、 Automotive electronics: 17.7N, 60S<math>\pm</math>1s, X , Ydirect.</li> </ol>   |

## ◆ Recommended Soldering Technologies

### (1) Re-flowing Profile

Preheat condition: 150 ~200°C/60~180sec.

Allowed time above 217°C: 80~120sec.

Max temp: 260°C

Max time at max temp: 10 sec.

Solder paste: Sn/3.0Ag/0.5Cu

Allowed Reflow time: 2x max

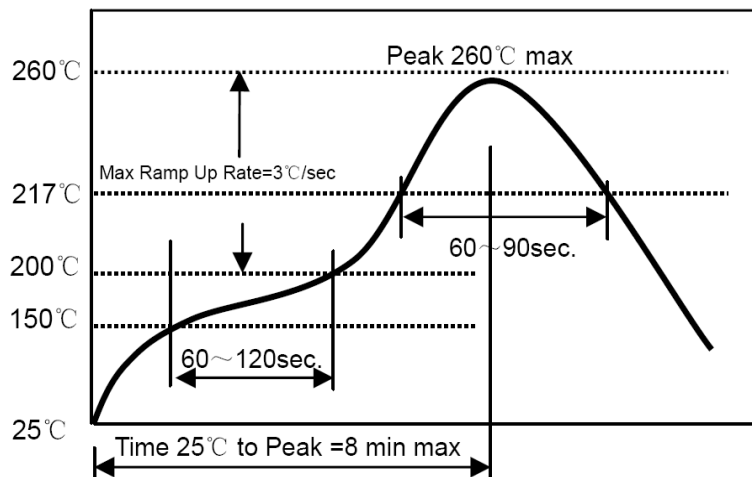

### (2) Iron Soldering Profile

Iron soldering power: Max. 30W

Pre-heating: 150°C/60sec.

Soldering time: 3sec. Max.

Solder paste: Sn/3.0Ag/0.5Cu

Max.1 times for iron soldering

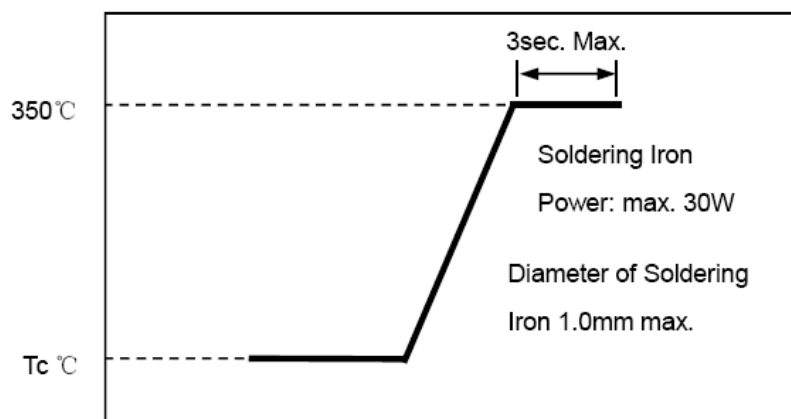

## ◆ Packaging Information

### (1) Tape Packaging Dimensions (Unit: mm)

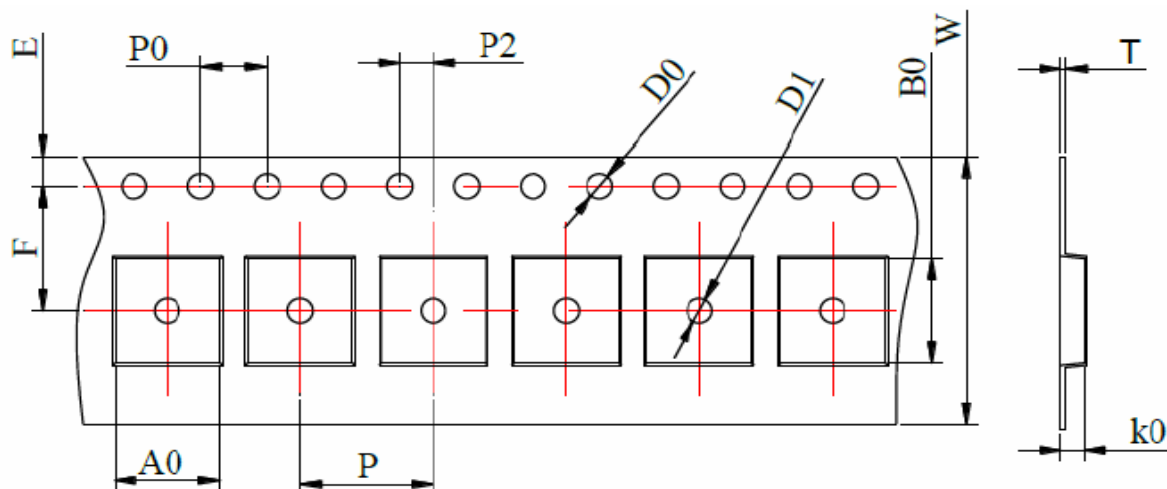

| Type    | Tape dimensions (mm) |            |           |            |             |             |              |              |              |             |              |              |
|---------|----------------------|------------|-----------|------------|-------------|-------------|--------------|--------------|--------------|-------------|--------------|--------------|
|         | W                    | P          | P0        | P2         | D0          | D1          | T            | A0           | B0           | K0          | E            | F            |
| SLO1050 | 24<br>±0.3           | 16<br>±0.1 | 4<br>±0.1 | 2<br>±0.05 | 1.5<br>±0.1 | 1.5<br>±0.1 | 0.4<br>±0.05 | 10.4<br>±0.1 | 11.6<br>±0.1 | 5.4<br>±0.1 | 1.75<br>±0.1 | 11.5<br>±0.1 |

### Taping Drawings (UNIT:mm)

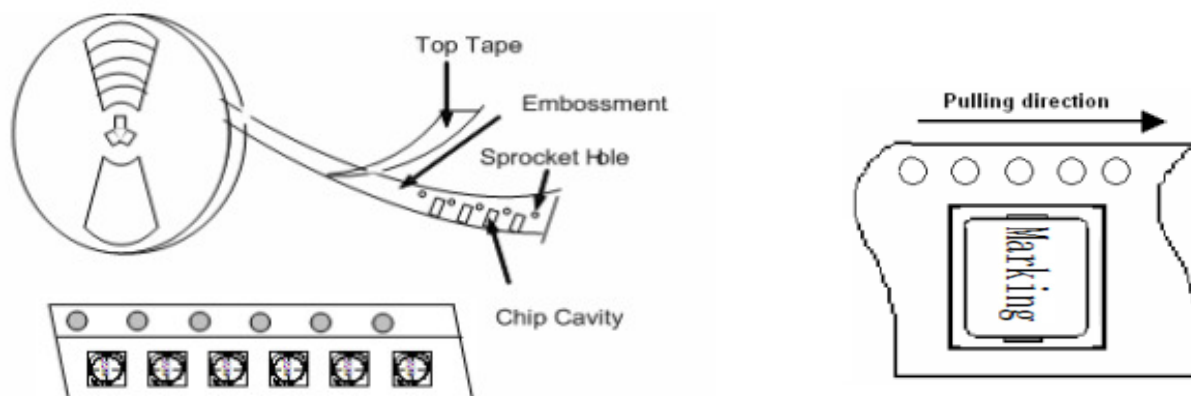

## (2) Reel Dimensions (Unit: mm)

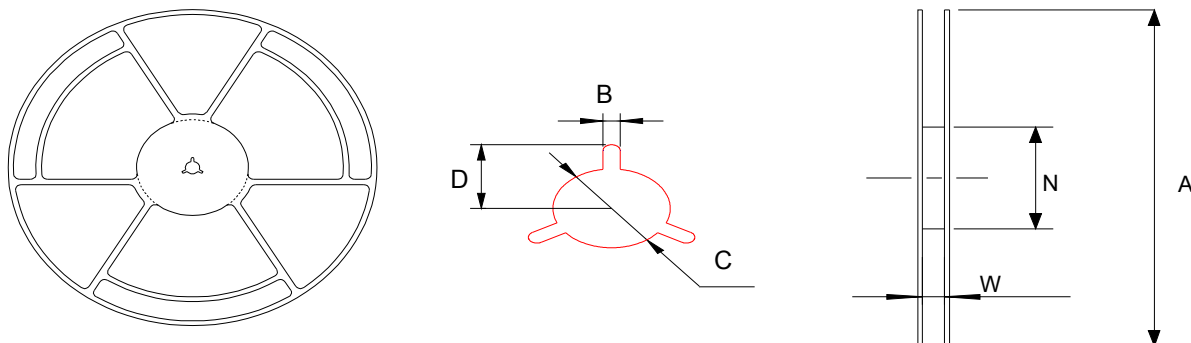

| A       | W      | N      | B       | C        | D          |
|---------|--------|--------|---------|----------|------------|
| 330±2.0 | 24±0.5 | 97±0.5 | 2.2±0.5 | 13.0±0.2 | 10.75±0.25 |

## (3) Packaging Quantity(PCS)

| Type    | Standard Quantity |                        |                               |
|---------|-------------------|------------------------|-------------------------------|
|         | Reel              | Inner box              | Carton box                    |
| SLO1050 | 500 pcs / reel    | 2Reel / box (1000 pcs) | 4 Middle boxes,<br>(4000 pcs) |

## (4) Peel force of top cover tape

The peel speed shall be about 300mm/minute

The peel force of top cover tape shall be between 0.1 to 1.3 N

