

Description

The HSW3415 is the high cell density trenched P-ch MOSFETs, which provide excellent $R_{DS(ON)}$ and gate charge for most of the synchronous buck converter applications.

The HSW3415 meet the RoHS and Green Product requirement with full function reliability approved.

- Super Low Gate Charge
- Green Device Available
- Excellent CdV/dt effect decline
- Advanced high cell density Trench technology
- ESD Protect 2.5KV

Product Summary

V_{DS}	-20	V
$R_{DS(ON),typ}$	29	m Ω
I_D	-5	A

SOT23-6L Pin Configurations

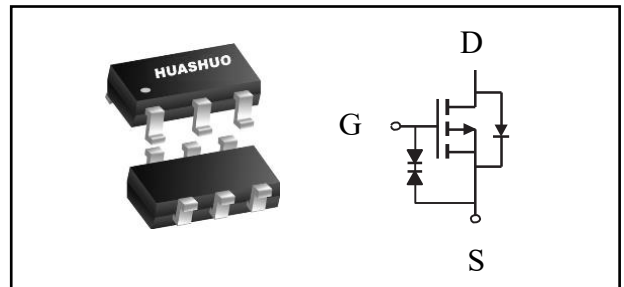

Absolute Maximum Ratings

Symbol	Parameter	Rating	Units
V_{DS}	Drain-Source Voltage	-20	V
V_{GS}	Gate-Source Voltage	± 8	V
$I_D@T_A=25^\circ C$	Continuous Drain Current, $V_{GS} @ -4.5V_1$	-5	A
$I_D@T_A=70^\circ C$	Continuous Drain Current, $V_{GS} @ -4.5V_1$	-3.9	A
I_{DM}	Pulsed Drain Current $_2$	-20	A
$P_D@T_A=25^\circ C$	Total Power Dissipation $_3$	1.4	W
$P_D@T_A=70^\circ C$	Total Power Dissipation $_3$	0.84	W
T_{STG}	Storage Temperature Range	-55 to 150	$^\circ C$
T_J	Operating Junction Temperature Range	-55 to 150	$^\circ C$

Thermal Data

Symbol	Parameter	Typ.	Max.	Unit
$R_{\theta JA}$	Thermal Resistance Junction-Ambient $_1$	---	100	$^\circ C/W$



Electrical Characteristics (T_J=25 °C, unless otherwise noted)

Symbol	Parameter	Conditions	Min.	Typ.	Max.	Unit
B _{VDS}	Drain-Source Breakdown Voltage	V _{GS} =0V, I _D =-250uA	-20	---	---	V
ΔB _{VDS} /ΔT _J	B _{VDS} Temperature Coefficient	Reference to 25°C, I _D =-1mA	---	-0.014	---	V/°C
R _{DS(ON)}	Static Drain-Source On-Resistance ₂	V _{GS} =-4.5V, I _D =-5A	---	29	35	mΩ
		V _{GS} =-2.5V, I _D =-3A	---	37	45	
V _{GS(th)}	Gate Threshold Voltage	V _{GS} =V _{DS} , I _D =-250uA	-0.4	-0.6	-0.9	V
ΔV _{GS(th)}	V _{GS(th)} Temperature Coefficient		---	3.95	---	mV/°C
I _{DSS}	Drain-Source Leakage Current	V _{DS} =-16V, V _{GS} =0V, T _J =25°C	---	---	-1	uA
		V _{DS} =-16V, V _{GS} =0V, T _J =55°C	---	---	-5	
I _{GSS}	Gate-Source Leakage Current	V _{GS} =±8V, V _{DS} =0V	---	---	±100	nA
g _{fs}	Forward Transconductance	V _{DS} =-5V, I _D =-3A	---	12.8	---	S
Q _g	Total Gate Charge (-4.5V)	V _{DS} =-15V, V _{GS} =-4.5V, I _D =-3A	---	8.4	11	nC
Q _{gs}	Gate-Source Charge		---	2.4		
Q _{gd}	Gate-Drain Charge		---	1.5		
T _{d(on)}	Turn-On Delay Time	V _{DD} =-10V, V _{GS} =-4.5V, R _G =3.3Ω, I _D =-3A	---	12	---	ns
T _r	Rise Time		---	9	---	
T _{d(off)}	Turn-Off Delay Time		---	19	---	
T _f	Fall Time		---	29	---	
C _{iss}	Input Capacitance	V _{DS} =-10V, V _{GS} =0V, f=1MHz	---	755		pF
C _{oss}	Output Capacitance		---	113		
C _{rss}	Reverse Transfer Capacitance		---	80		

Diode Characteristics

Symbol	Parameter	Conditions	Min.	Typ.	Max.	Unit
I _S	Continuous Source Current _{1,4}	V _G =V _D =0V, Force Current	---	---	-5	A
I _{SM}	Pulsed Source Current _{2,4}		---	---	-20	A
V _{SD}	Diode Forward Voltage ₂	V _{GS} =0V, I _S =-1A, T _J =25°C	---	---	-1.2	V

Note :

- 1.The data tested by surface mounted on a 1 inch² FR-4 board with 20Z copper.
- 2.The data tested by pulsed , pulse width ≤ 300us , duty cycle ≤ 2%
- 3.The power dissipation is limited by 150°C junction temperature
- 4.The data is theoretically the same as I_D and I_{DM} , in real applications , should be limited by total power dissipation.

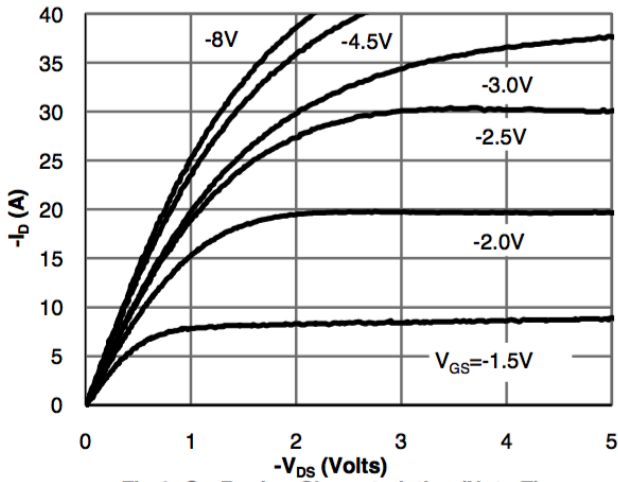

Fig 1: On-Region Characteristics (Note E)

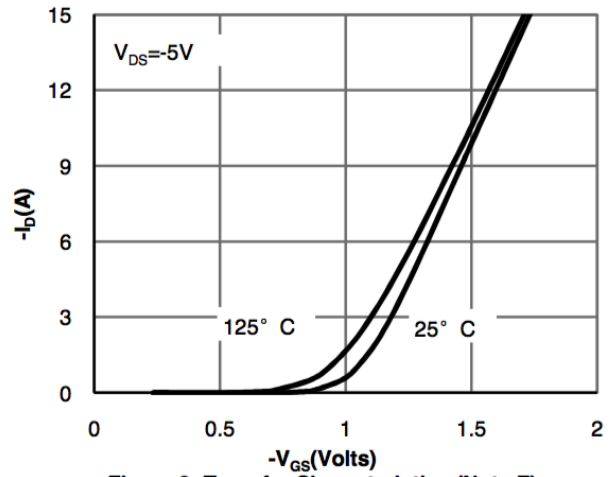

Figure 2: Transfer Characteristics (Note E)

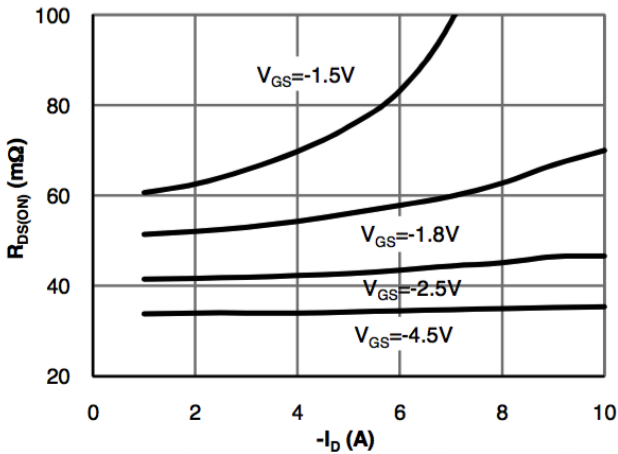

Figure 3: On-Resistance vs. Drain Current and Gate Voltage (Note E)

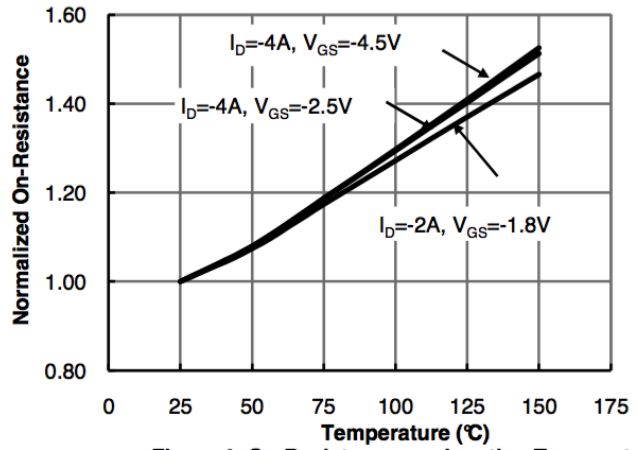

Figure 4: On-Resistance vs. Junction Temperature (Note E)

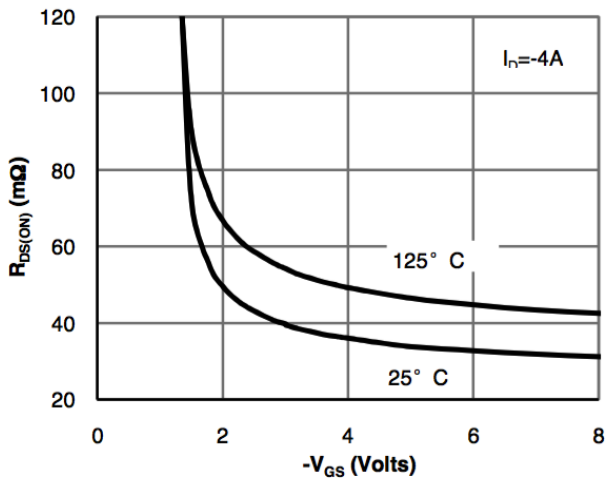

Figure 5: On-Resistance vs. Gate-Source Voltage (Note E)

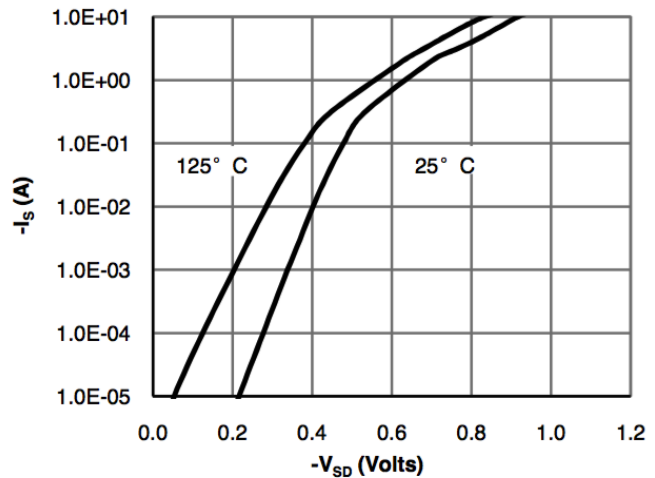

Figure 6: Body-Diode Characteristics (Note E)

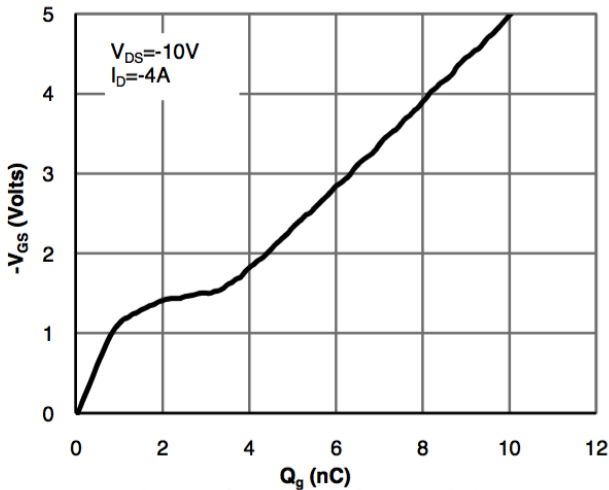

Figure 7: Gate-Charge Characteristics

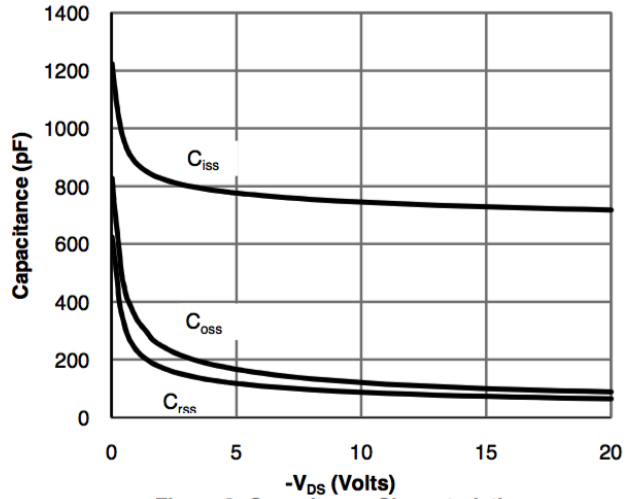

Figure 8: Capacitance Characteristics

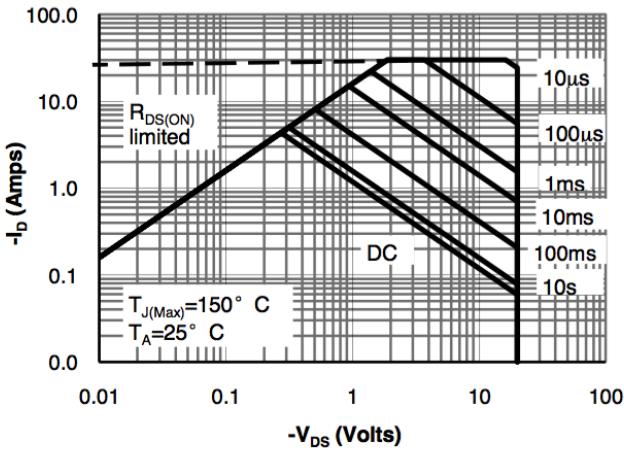

Figure 9: Maximum Forward Biased Safe Operating Area (Note F)

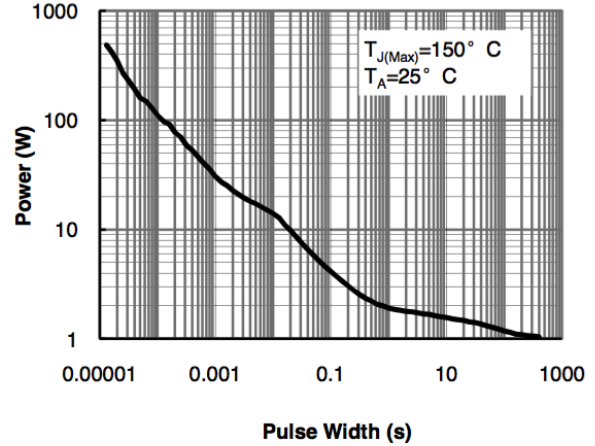

Figure 10: Single Pulse Power Rating Junction-to-Ambient (Note F)

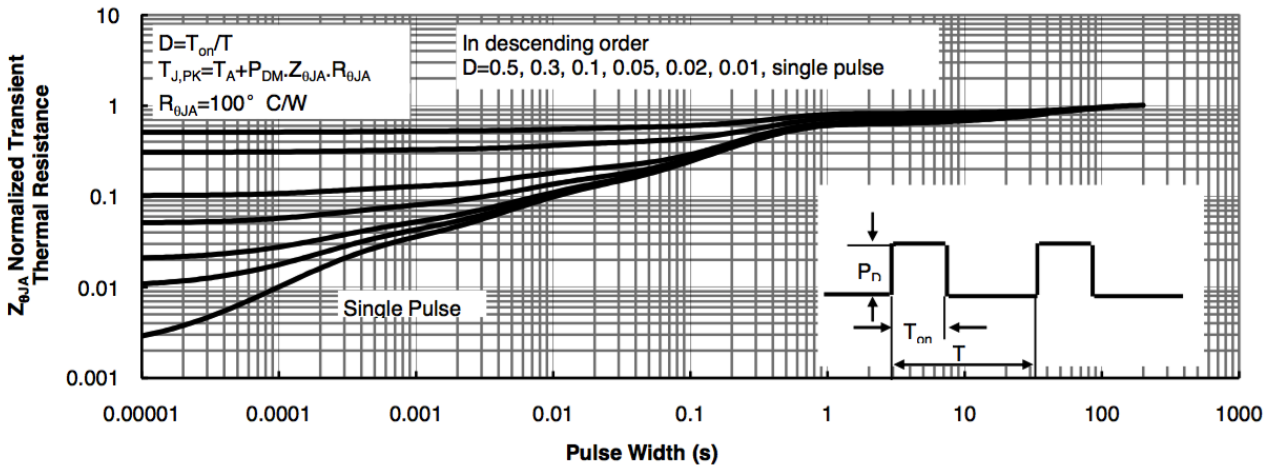
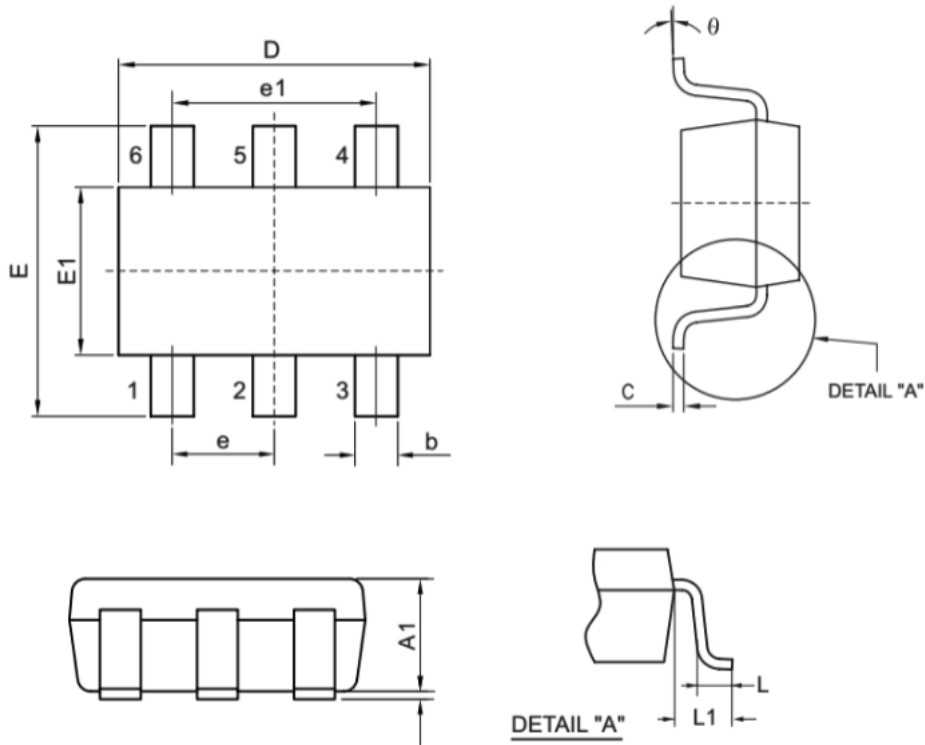

Figure 11: Normalized Maximum Transient Thermal Impedance (Note F)



Ordering Information

Part Number	Package code	Packaging
HSW3415	SOT23-6L	3000/Tape&Reel



SYMBOLS	MILLIMETERS		INCHES	
	MIN	MAX	MIN	MAX
D	2.692	3.099	0.106	0.122
E	2.591	3.000	0.102	0.118
E1	1.397	1.803	0.055	0.071
e	0.950 REF.		0.037 REF.	
e1	1.900 REF.		0.075 REF.	
b	0.300	0.500	0.012	0.020
C	0.080	0.200	0.003	0.008
A	0.000	0.100	0.000	0.004
A1	0.700	1.200	0.028	0.048
L	0.300	0.600	0.012	0.024
L1	0.600 REF.		0.023 REF.	
θ	0°	9°	0°	9°