

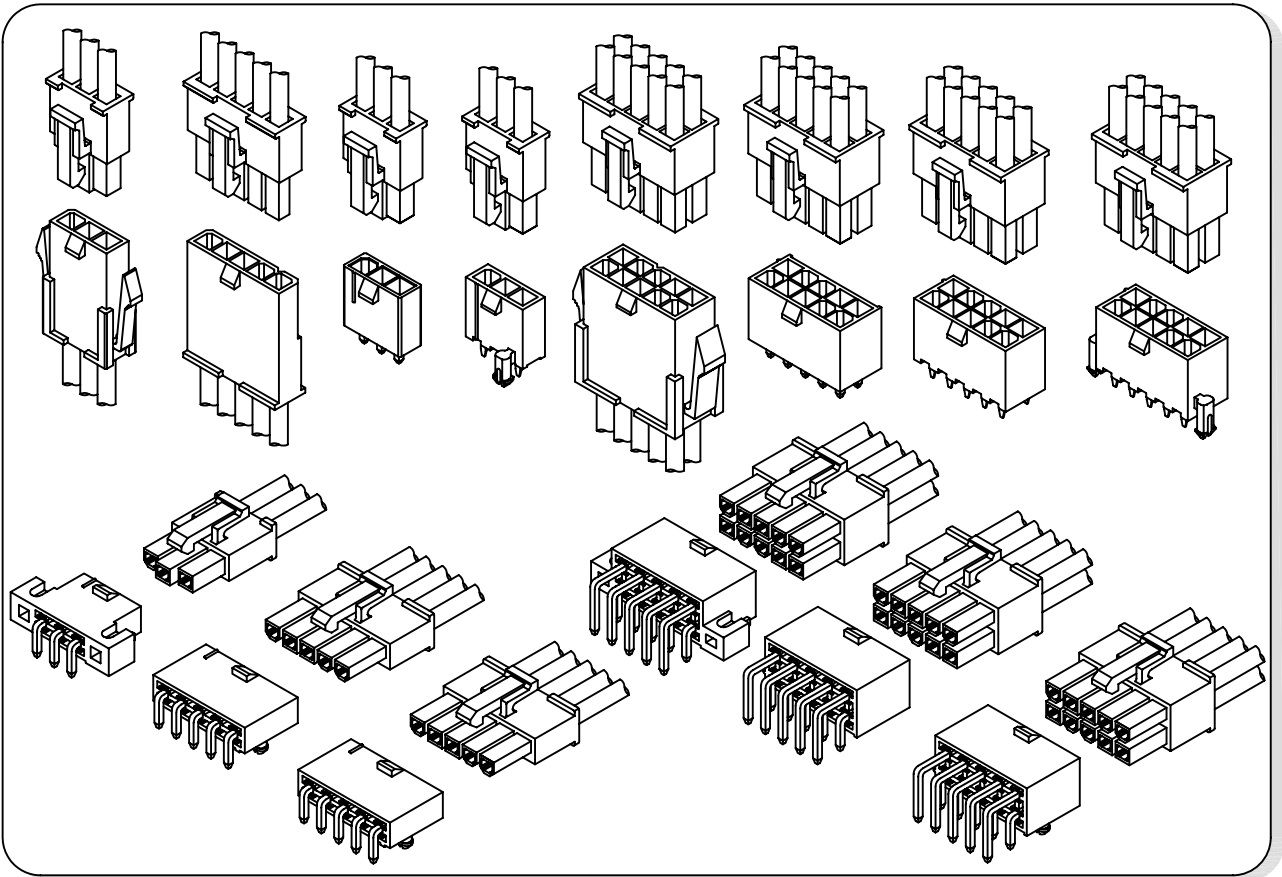

C4201 SERIES

4.20mm pitch wire to wire and wire to board connector



Specifications

- Current rating: 9A AC, DC Max
- Voltage rating: 600V AC, DC
- Temperature range: -40°C ~ +105°C
- Contact resistance: 10mΩ Max.
- Insulation resistance: 1000MΩ Min.
- Withstanding voltage: 1500V AC/minute
- *Compliant with RoHS and REACH*
- *Meet the HF/Halogen Free, GWT/Glow wire Test (IEC60335-1) request, need to customize*
- *Contact CJT for details*

Standards



Panel hole layout

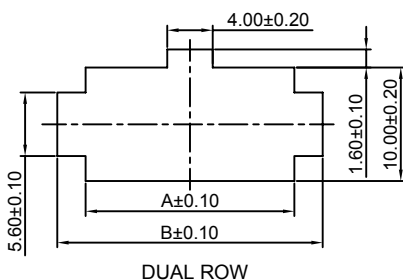

DUAL ROW

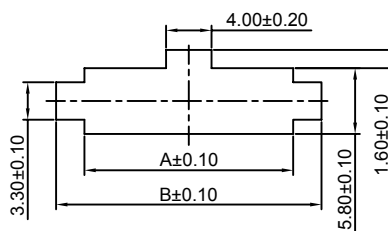

SINGLE ROW

PART NO.		Dimensions	
SINGLE ROW	DUAL ROW	A	B
-----	C4201HM-2x1P	5.80	10.80
C4201HM-2P	C4201HM-2x2P	10.00	15.00
C4201HM-3P	C4201HM-2x3P	14.20	19.20
C4201HM-4P	C4201HM-2x4P	18.40	23.40
C4201HM-5P	C4201HM-2x5P	22.60	27.60
C4201HM-6P	C4201HM-2x6P	26.80	31.80
C4201HM-7P	C4201HM-2x7P	31.00	36.00
C4201HM-8P	C4201HM-2x8P	35.20	40.20
C4201HM-9P	C4201HM-2x9P	39.40	44.40
C4201HM-10P	C4201HM-2x10P	43.60	48.60
C4201HM-11P	C4201HM-2x11P	47.80	52.80
C4201HM-12P	C4201HM-2x12P	52.00	57.00

Unit:mm



Assembly layout

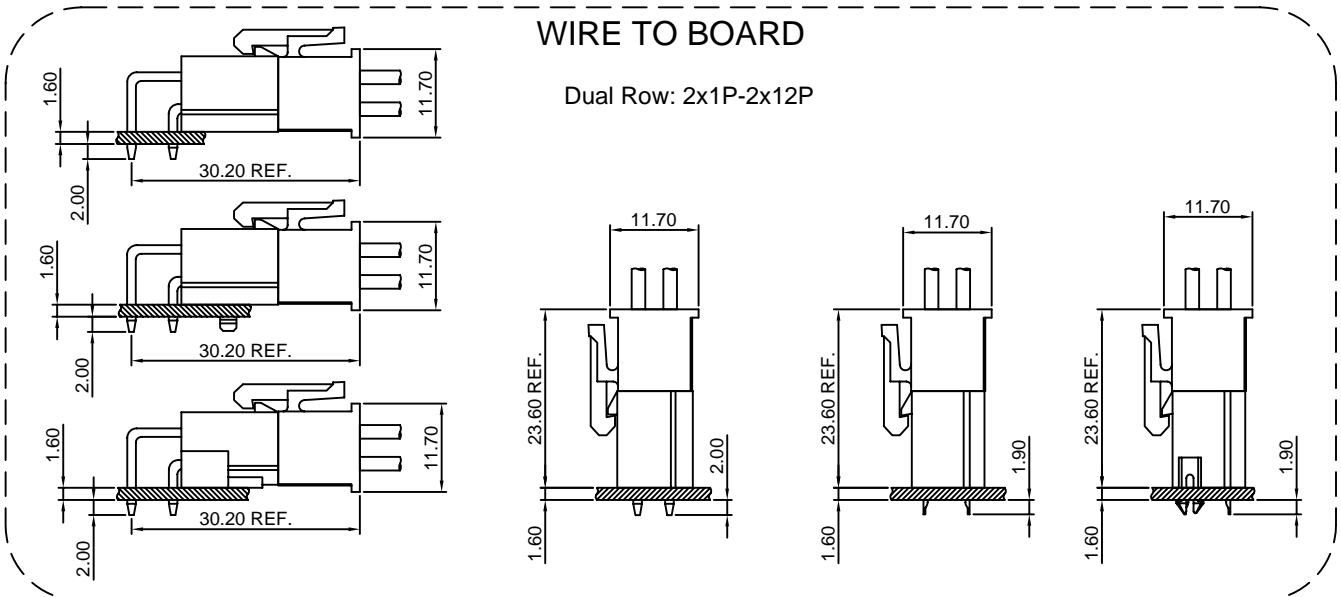
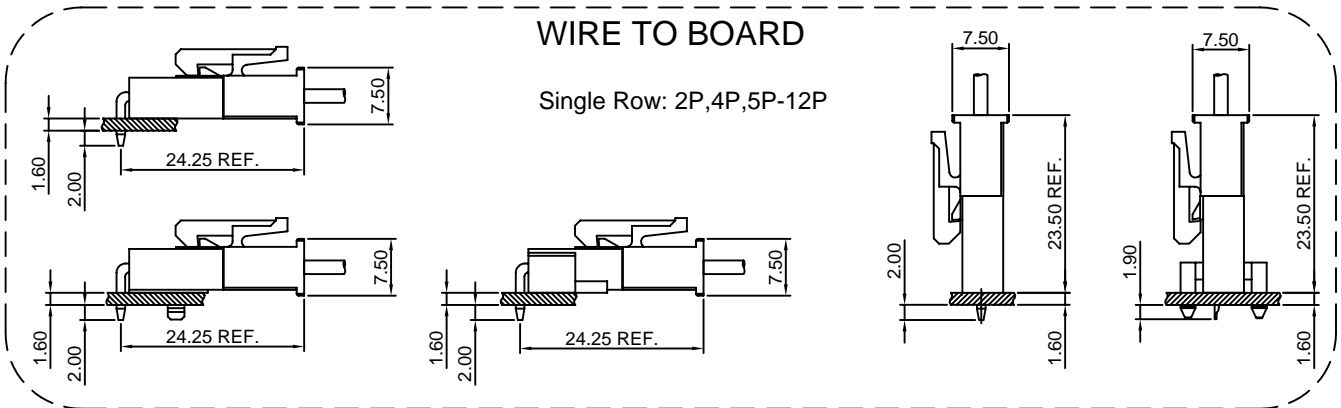
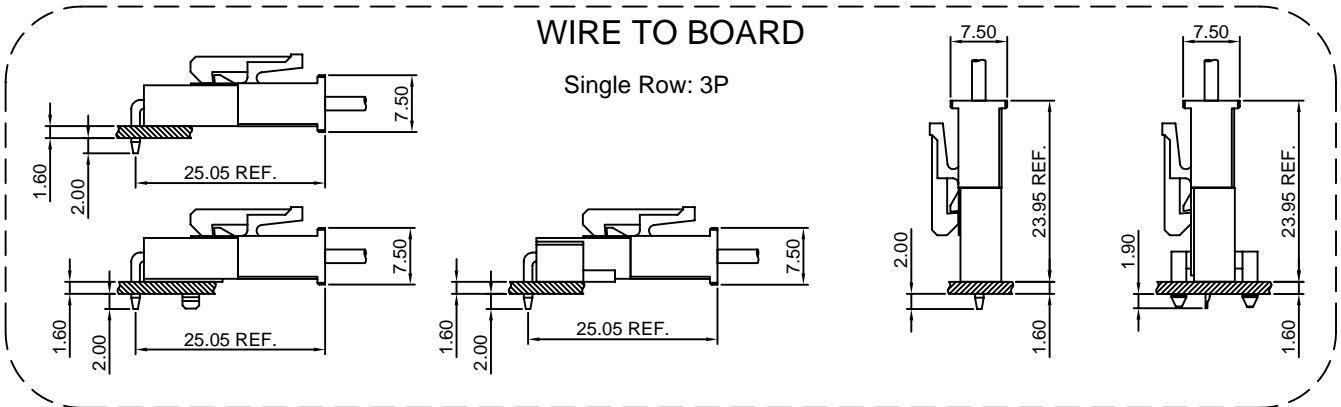
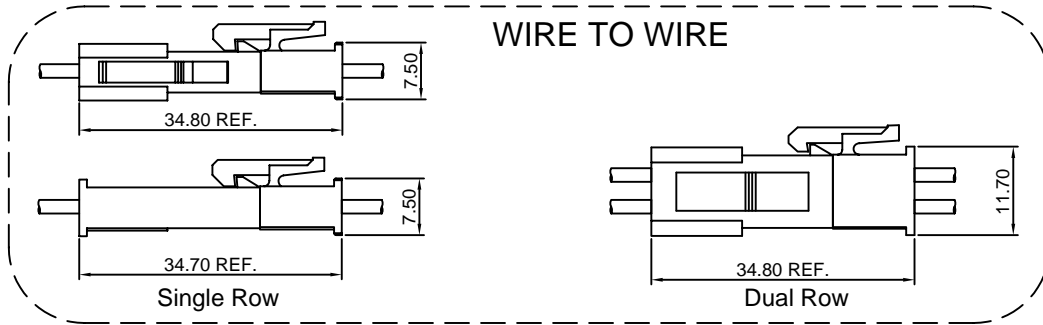



C4201 SERIES

4.20mm pitch wire to wire and wire to board connector

C4201HF

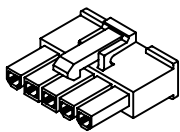

C4201HF

C4201HM

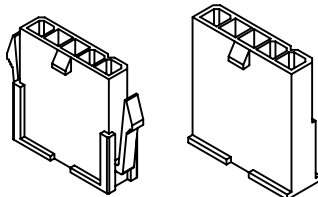

C4201HM

C4201HMA

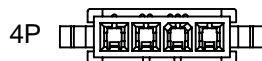
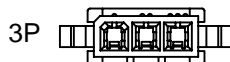
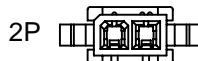

C4201WV C4201WVA-F

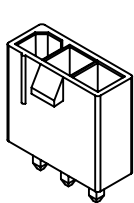

C4201WV

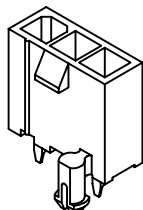

C4201WVA-F

C4201WR C4201WR-E

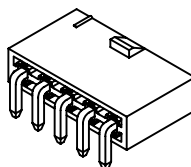

C4201WR

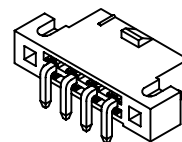

C4201WR-E

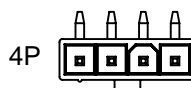
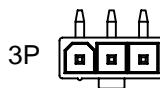
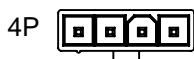



C4201 SERIES

4.20mm pitch wire to wire and wire to board connector

C4201HF-2

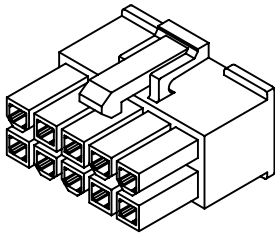

C4201HF-2

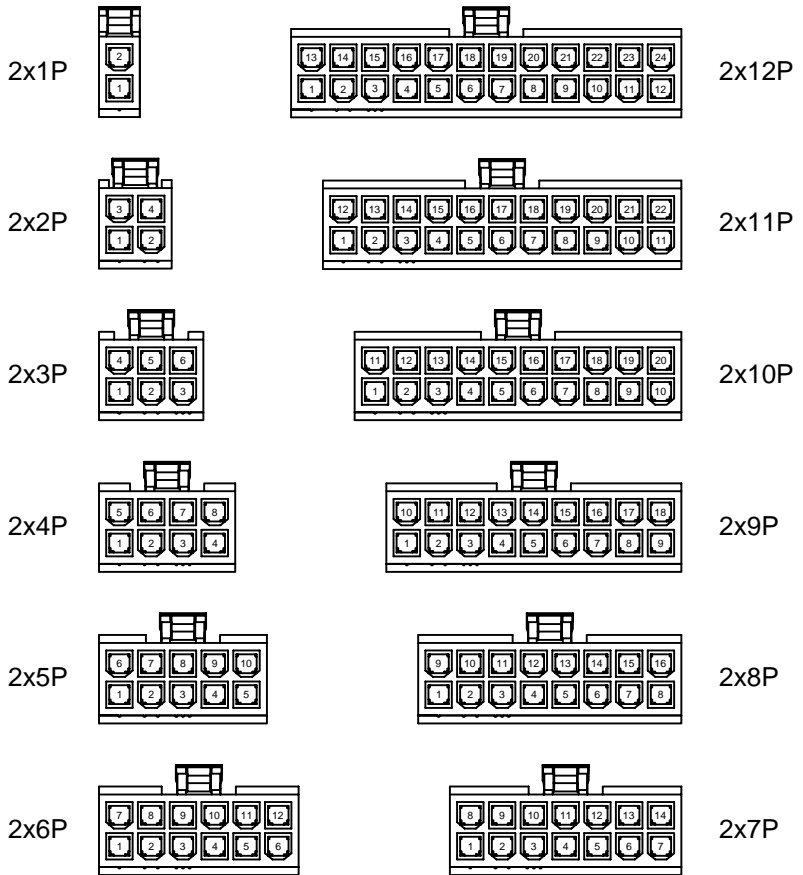

C4201HM-2 C4201HMA-2

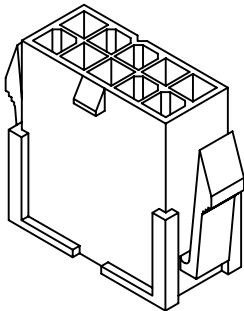

C4201HM-2

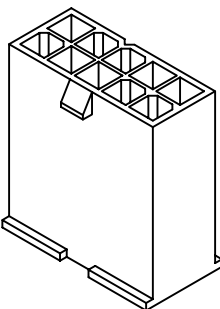

C4201HMA-2

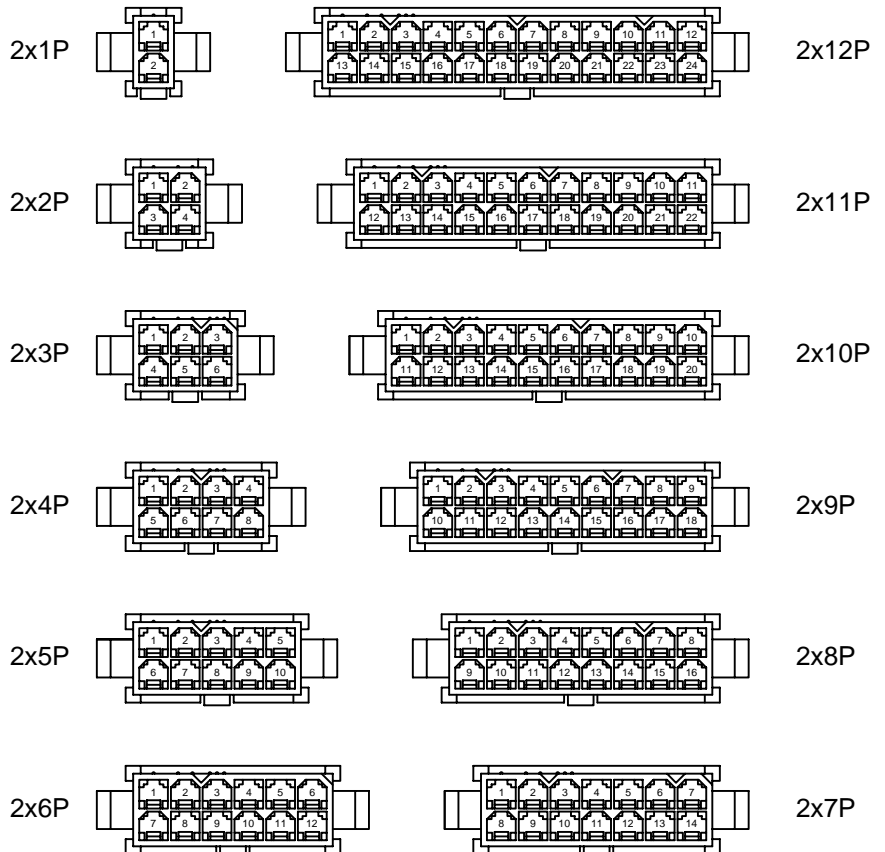



C4201 SERIES

4.20mm pitch wire to wire and wire to board connector

C4201WV-2 C4201WVA-2 C4201WVA-F-2

C4201WV-2

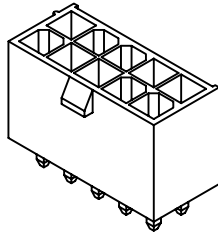

2x1P

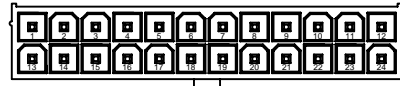

2x12P

2x2P

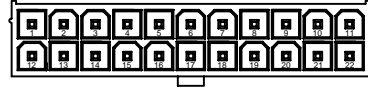

2x11P

C4201WVA-2

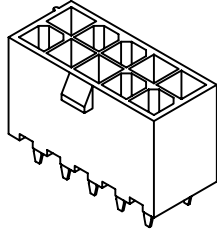

2x3P

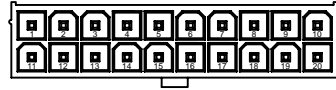
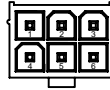

2x10P

2x4P

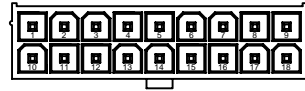
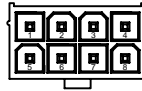

2x9P

C4201WVA-F-2

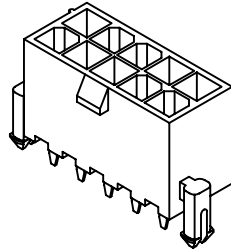

2x5P

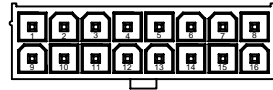
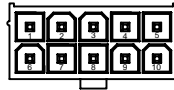

2x8P

2x6P

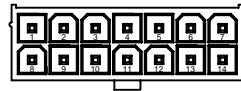
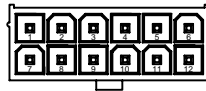

2x7P

C4201WR-2 C4201WR-E-2 C4201WR-F-2

C4201WR-2

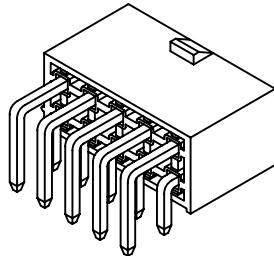

2x1P

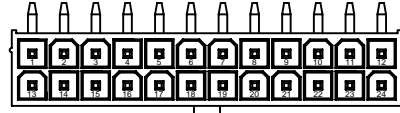

2x12P

2x2P

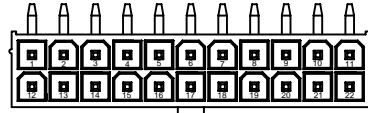
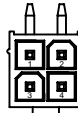

2x11P

C4201WR-E-2

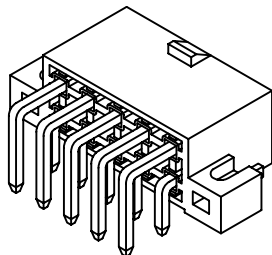

2x3P

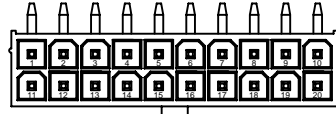
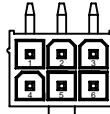

2x10P

2x4P

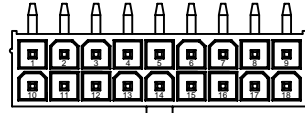
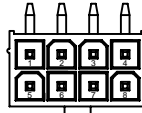

2x9P

C4201WR-F-2

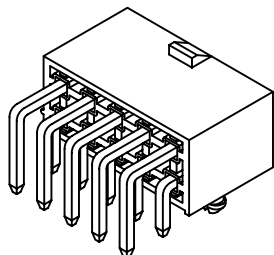

2x5P

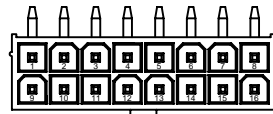
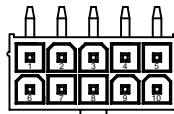

2x8P

2x6P

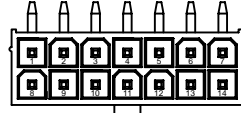
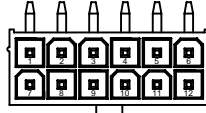

2x7P



C4201 SERIES

4.20mm pitch wire to wire and wire to board connector

C4201HFA-2

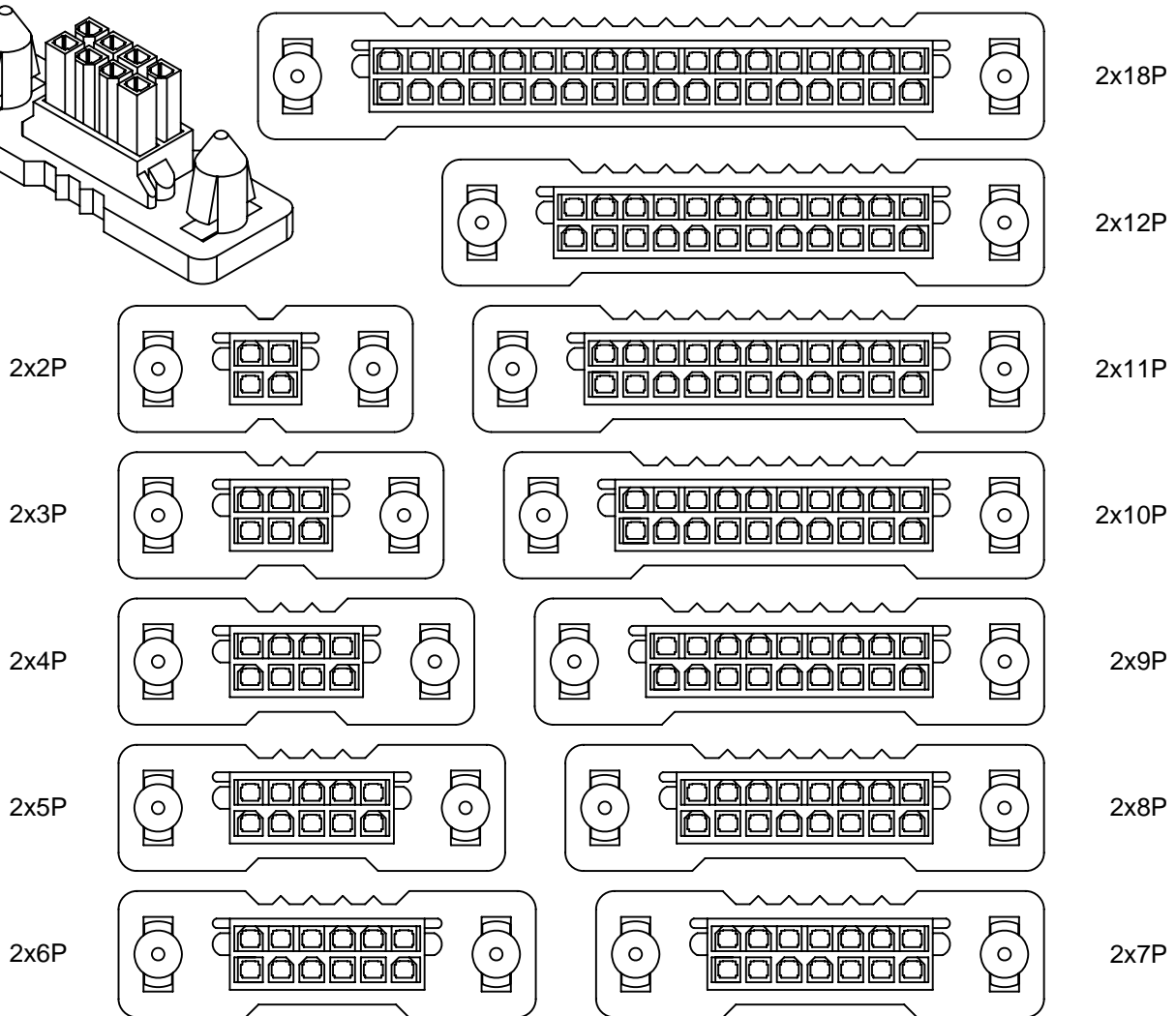
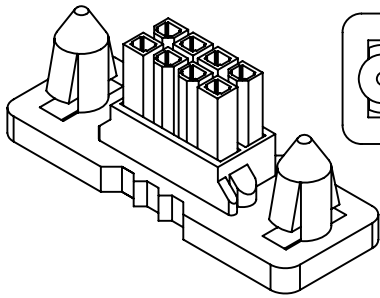

C4201HV-2

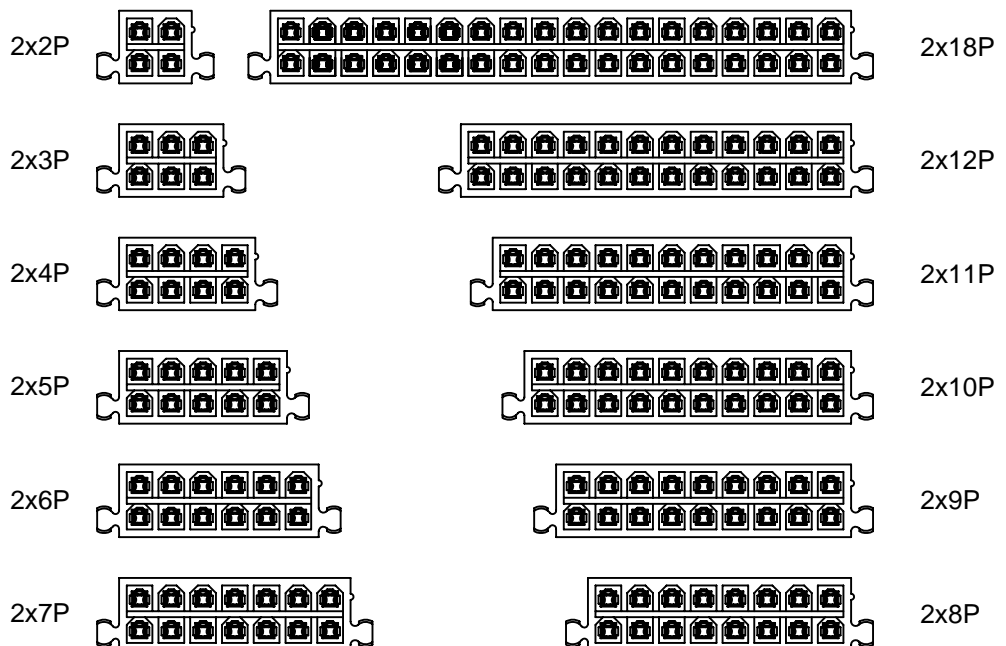
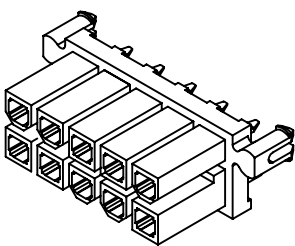



C4201 SERIES

4.20mm pitch wire to wire and wire to board connector

C4201HMB-2

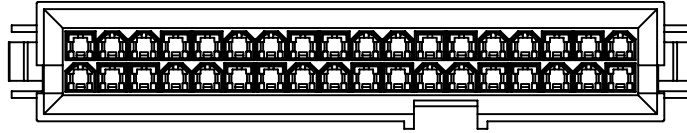
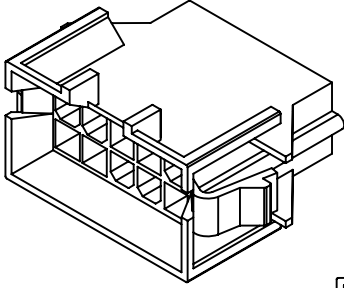

2x18P

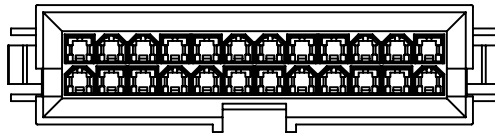

2x12P

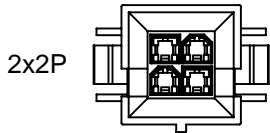

2x2P

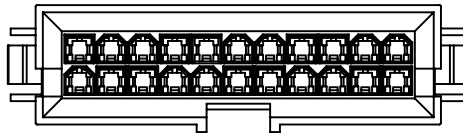

2x11P

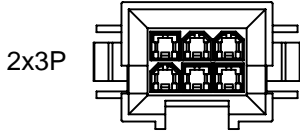

2x3P

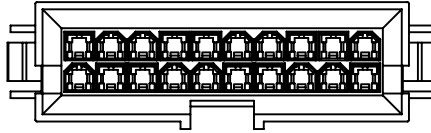

2x10P

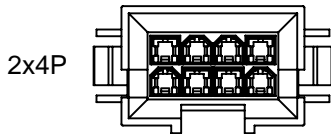

2x4P

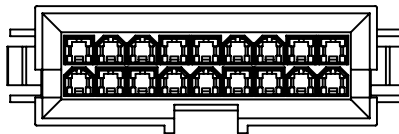

2x9P

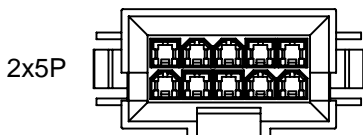

2x5P

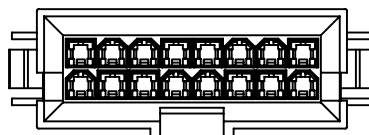

2x8P

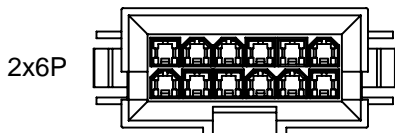

2x6P

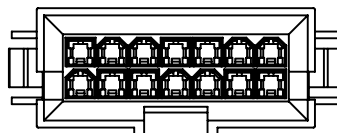

2x7P



C4201 SERIES

4.20mm pitch wire to wire and wire to board connector

C4201WVA-F1-2

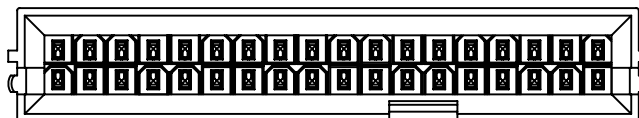
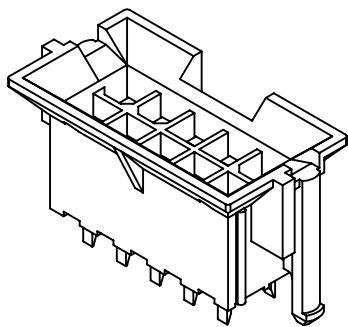

2x18P

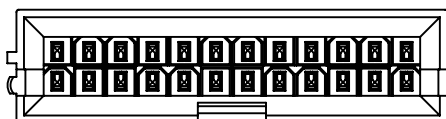

2x12P

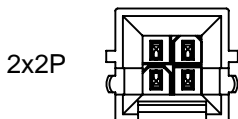

2x2P

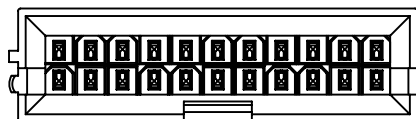

2x11P

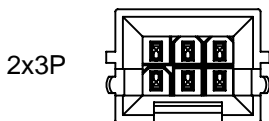

2x3P

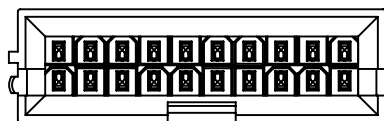

2x10P

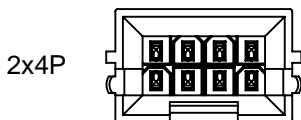

2x4P

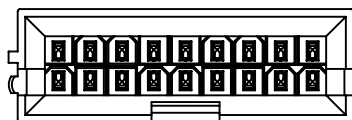

2x9P

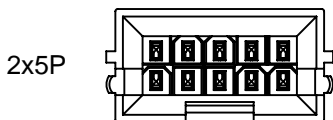

2x5P

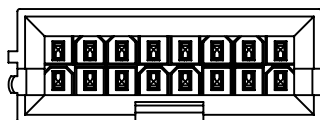

2x8P

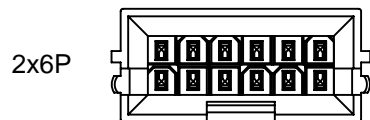

2x6P

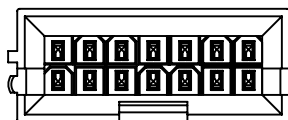

2x7P



C4201 SERIES

4.20mm pitch wire to wire and wire to board connector

C4201WR-F1-2

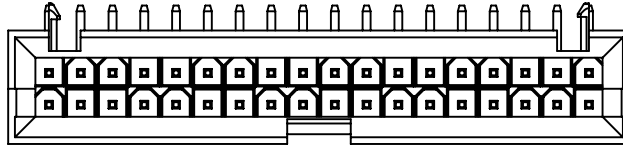
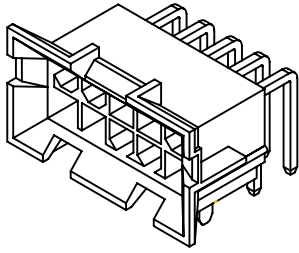

2x18P

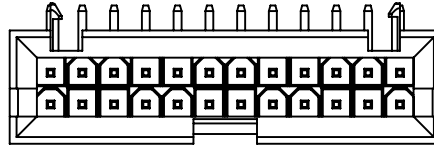

2x12P

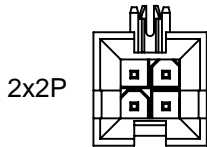

2x2P

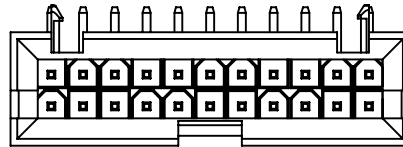

2x11P

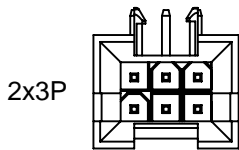

2x3P

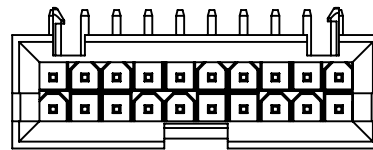

2x10P

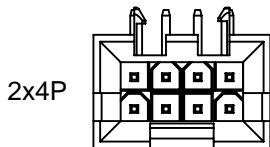

2x4P

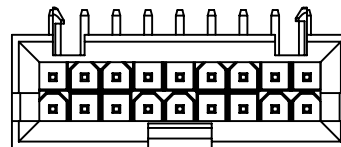

2x9P

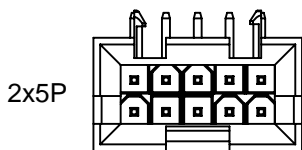

2x5P

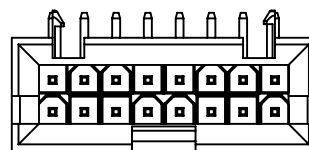

2x8P

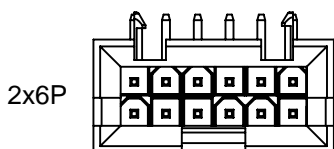

2x6P

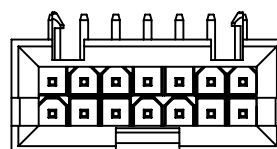

2x7P



C4201 SERIES

4.20mm pitch wire to wire and wire to board connector

C4201F-T

4.20mm pitch Crimp Terminal

Reference Informations:

*Used in CJT C4201HF series Housing

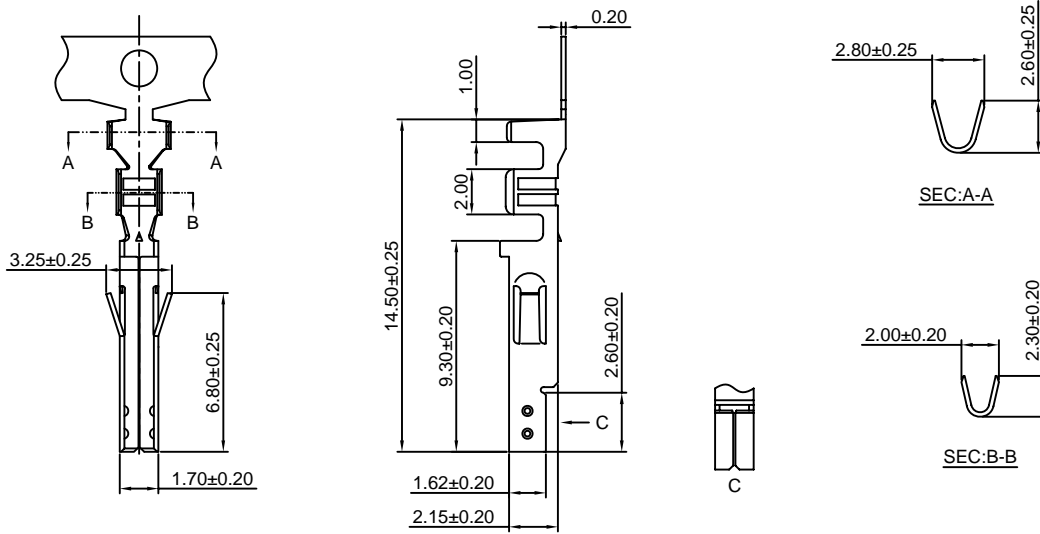

Ordering information & Specifications:

Unit:mm

Part NO.	Wire Range	Insulation O.D.	Material	Finish	Qty/reel
C4201F-TB	AWG#22-#28	1.80mm(max)	Brass	Tin over Nickel	10,000 PCS
C4201F-TP	AWG#22-#28	1.80mm(max)	Phosphor Bronze	Tin over Nickel	10,000 PCS
C4201F-GB	AWG#22-#28	1.80mm(max)	Brass	Gold over Nickel	10,000 PCS
C4201F-GP	AWG#22-#28	1.80mm(max)	Phosphor Bronze	Gold over Nickel	10,000 PCS

Optional Gold plating available but MOQ requested

C4201M-T

4.20mm pitch Crimp Terminal

Reference Informations:

*Used in CJT C4201HM or C4201HMA series Housing

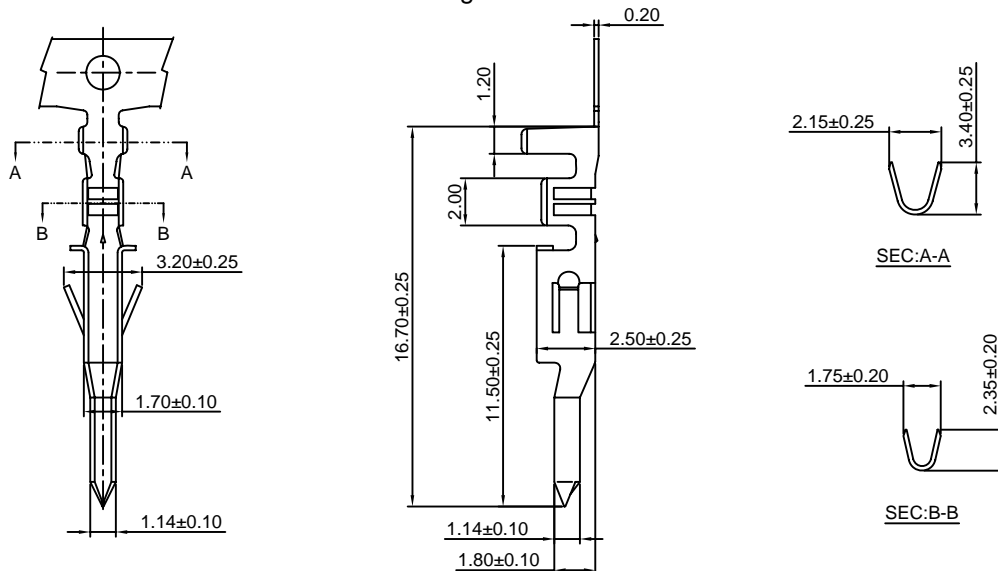

Ordering information & Specifications:

Unit:mm

Part NO.	Wire Range	Insulation O.D.	Material	Finish	Qty/reel
C4201M-TB	AWG#22-#28	1.80mm(max)	Brass	Tin over Nickel	5,000 PCS
C4201M-TP	AWG#22-#28	1.80mm(max)	Phosphor Bronze	Tin over Nickel	5,000 PCS
C4201M-GB	AWG#22-#28	1.80mm(max)	Brass	Gold over Nickel	5,000 PCS
C4201M-GP	AWG#22-#28	1.80mm(max)	Phosphor Bronze	Gold over Nickel	5,000 PCS

Optional Gold plating available but MOQ requested



C4201 SERIES

4.20mm pitch wire to wire and wire to board connector

C4201F-T-H

4.20mm pitch Crimp Terminal

Reference Informations:

*Used in CJT C4201HF series Housing

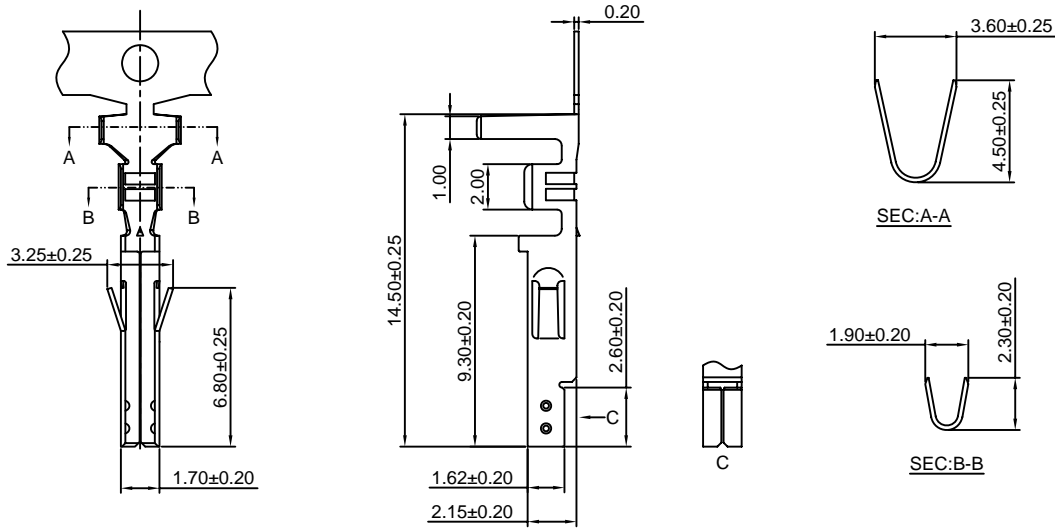

Ordering information & Specifications:

Unit:mm

Part NO.	Wire Range	Insulation O.D.	Material	Finish	Qty/reel
C4201F-TB-H	AWG#18-#24	3.10mm(max)	Brass	Tin over Nickel	4,500 PCS
C4201F-TP-H	AWG#18-#24	3.10mm(max)	Phosphor Bronze	Tin over Nickel	4,500 PCS
C4201F-GB-H	AWG#18-#24	3.10mm(max)	Brass	Gold over Nickel	4,500 PCS
C4201F-GP-H	AWG#18-#24	3.10mm(max)	Phosphor Bronze	Gold over Nickel	4,500 PCS

Optional Gold plating available but MOQ requested

C4201M-T-H

4.20mm pitch Crimp Terminal

Reference Informations:

*Used in CJT C4201HM or C4201HMA series Housing

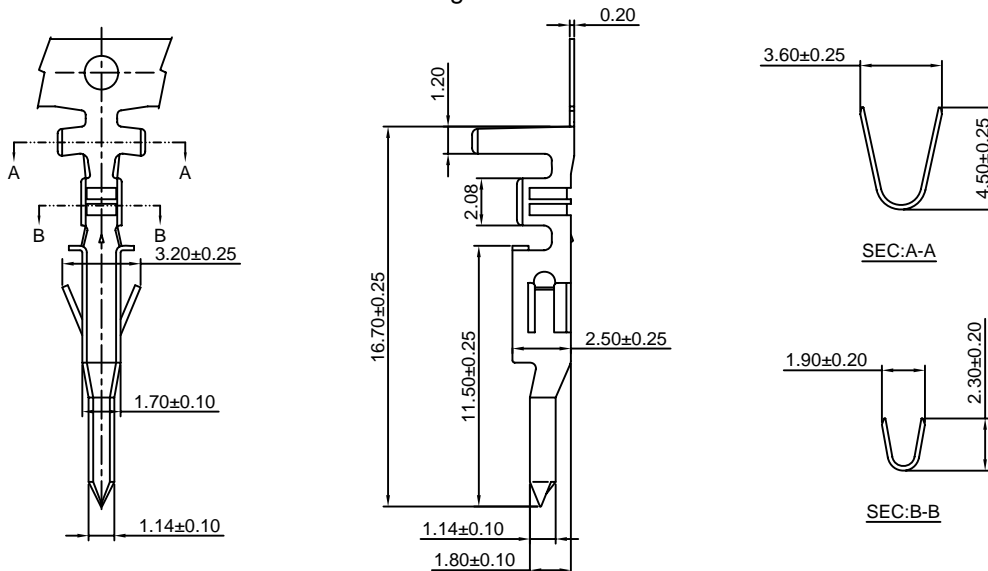

Ordering information & Specifications:

Unit:mm

Part NO.	Wire Range	Insulation O.D.	Material	Finish	Qty/reel
C4201M-TB-H	AWG#18-#24	3.10mm(max)	Brass	Tin over Nickel	5,000 PCS
C4201M-TP-H	AWG#18-#24	3.10mm(max)	Phosphor Bronze	Tin over Nickel	5,000 PCS
C4201M-GB-H	AWG#18-#24	3.10mm(max)	Brass	Gold over Nickel	5,000 PCS
C4201M-GP-H	AWG#18-#24	3.10mm(max)	Phosphor Bronze	Gold over Nickel	5,000 PCS

Optional Gold plating available but MOQ requested



C4201 SERIES

4.20mm pitch wire to wire and wire to board connector

C4201F-T-HH

4.20mm pitch Crimp Terminal

Reference Informations:

*Used in CJT C4201HF series Housing

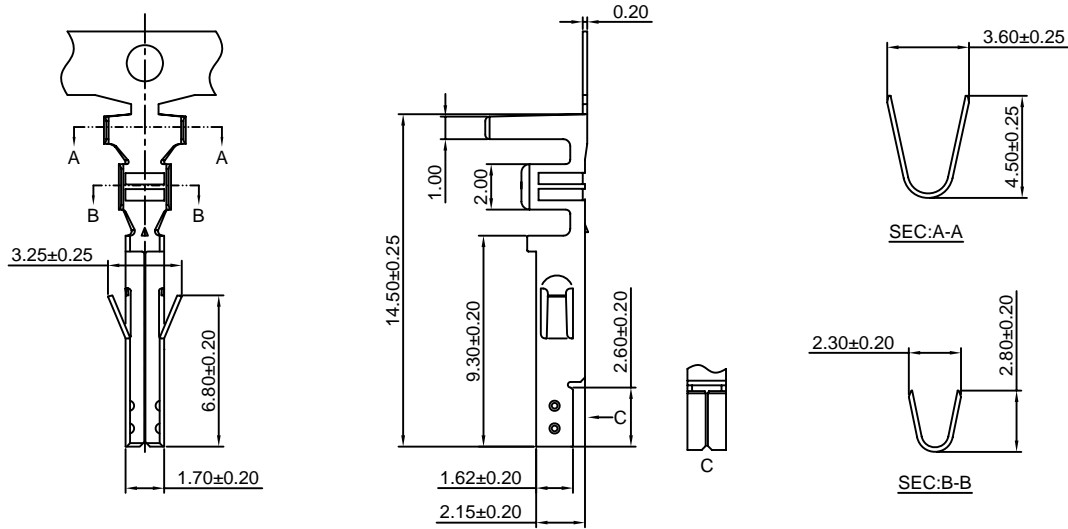

Ordering information & Specifications:

Unit:mm

Part NO.	Wire Range	Insulation O.D.	Material	Finish	Qty/reel
C4201F-TB-HH	AWG#16	4.30mm(max)	Brass	Tin over Nickel	4,500 PCS
C4201F-TP-HH	AWG#16	4.30mm(max)	Phosphor Bronze	Tin over Nickel	4,500 PCS
C4201F-GB-HH	AWG#16	4.30mm(max)	Brass	Gold over Nickel	4,500 PCS
C4201F-GP-HH	AWG#16	4.30mm(max)	Phosphor Bronze	Gold over Nickel	4,500 PCS

Optional Gold plating available but MOQ requested

C4201M-T-HH

4.20mm pitch Crimp Terminal

Reference Informations:

*Used in CJT C4201HM or C4201HMA series Housing

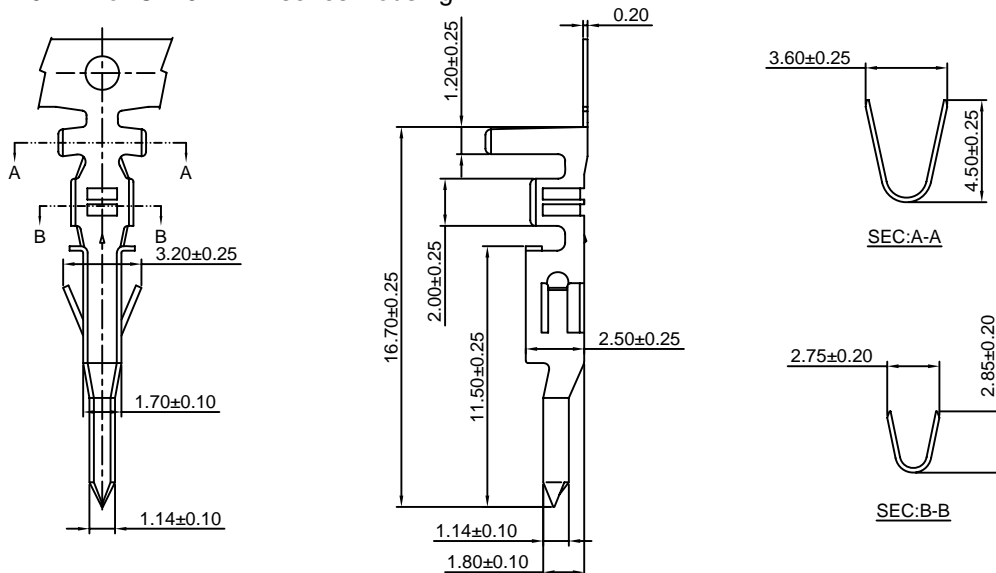

Ordering information & Specifications:

Unit:mm

Part NO.	Wire Range	Insulation O.D.	Material	Finish	Qty/reel
C4201M-TB-HH	AWG#16	4.30mm(max)	Brass	Tin over Nickel	4,000 PCS
C4201M-TP-HH	AWG#16	4.30mm(max)	Phosphor Bronze	Tin over Nickel	4,000 PCS
C4201M-GB-HH	AWG#16	4.30mm(max)	Brass	Gold over Nickel	4,000 PCS
C4201M-GP-HH	AWG#16	4.30mm(max)	Phosphor Bronze	Gold over Nickel	4,000 PCS

Optional Gold plating available but MOQ requested



C4201 SERIES

4.20mm pitch wire to wire and wire to board connector

C4201HF

4.20mm Pitch Single Row Housing

Reference Informations:

- *Material:Nylon 66,UL94V-2 or UL94V-0
- *Suitable CJT C4201F series Terminal
- *Mates with CJT C4201HM,C4201HMA series single row Housing or C4201 series single row Wafer
- *Color:Natural

Ordering Information:

- C4201HF-XP - **
 1 2
 1.Part No.
 2.Material:
 (blank):UL94V-2 /Natural
 V0:UL94V-0/White

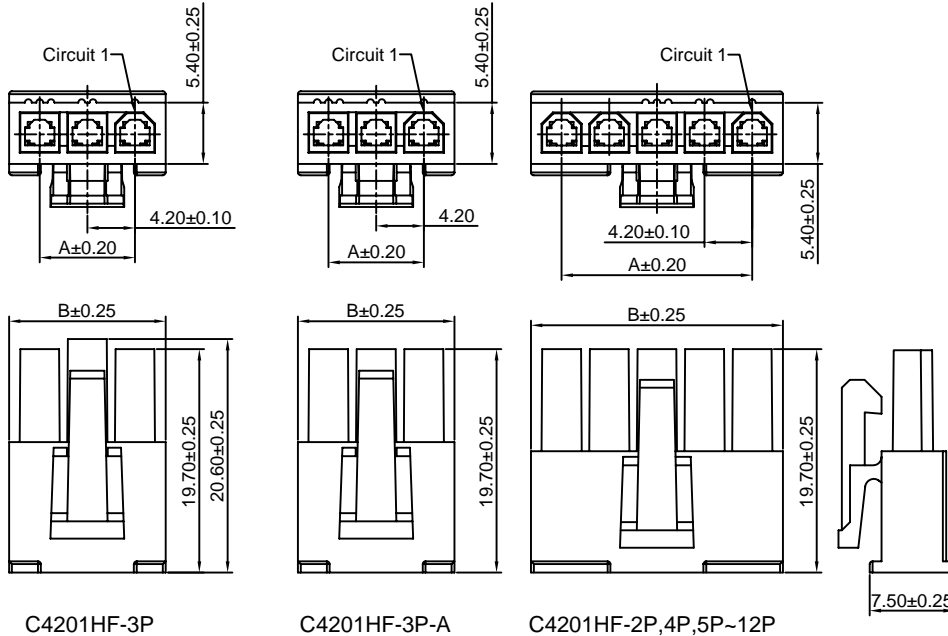
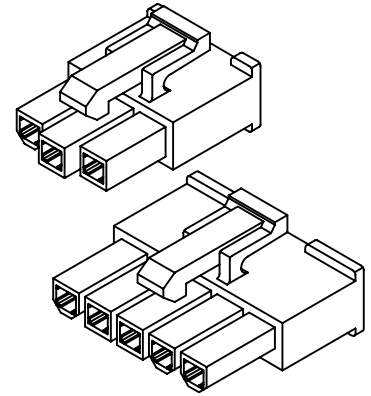

Ordering Information & Dimensions:

PART NO.	Dimensions	
	A	B
C4201HF-2P	4.20	9.60
C4201HF-3P	8.40	13.80
C4201HF-4P	12.60	18.00
C4201HF-5P	16.80	22.20
C4201HF-6P	21.00	26.40
C4201HF-7P	25.20	30.60
C4201HF-8P	29.40	34.80
C4201HF-9P	33.60	39.00
C4201HF-10P	37.80	43.20
C4201HF-11P	42.00	47.40
C4201HF-12P	46.20	51.60

Unit: mm

C4201HM

4.20mm Pitch Single Row Housing

Reference Informations:

- *Material:Nylon 66,UL94V-2 or UL94V-0
- *Suitable CJT C4201M series Terminal
- *Mates with CJT C4201HF series single row Housing
- *Color:Natural

Ordering Information:

- C4201HM-XP - **
 1 2
 1.Part No.
 2.Material:
 (blank):UL94V-2 /Natural
 V0:UL94V-0/White

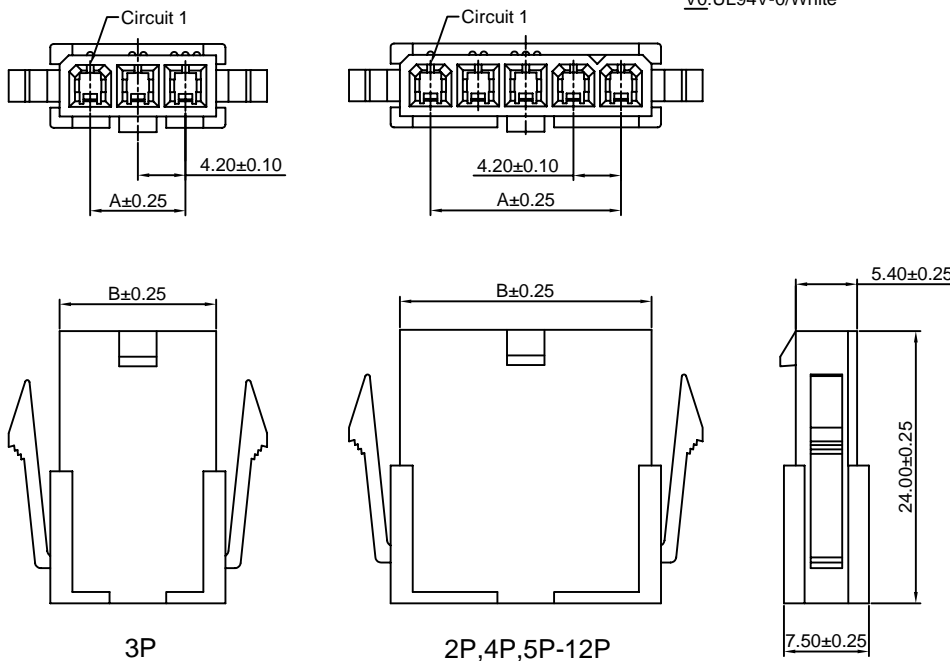
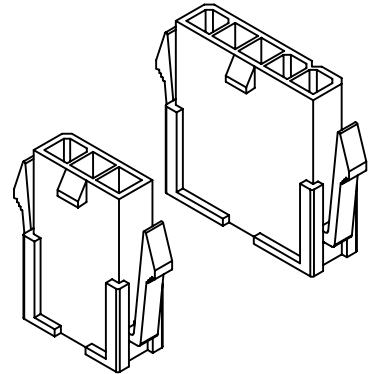

Ordering Information & Dimensions:

PART NO.	Dimensions	
	A	B
C4201HM-2P	4.20	9.60
C4201HM-3P	8.40	13.80
C4201HM-4P	12.60	18.00
C4201HM-5P	16.80	22.20
C4201HM-6P	21.00	26.40
C4201HM-7P	25.20	30.60
C4201HM-8P	29.40	34.80
C4201HM-9P	33.60	39.00
C4201HM-10P	37.80	43.20
C4201HM-11P	42.00	47.40
C4201HM-12P	46.20	51.60

Unit: mm



C4201 SERIES

4.20mm pitch wire to wire and wire to board connector

C4201HMA

4.20mm Pitch Single Row Housing - Without Mounting Ears

Reference Informations:

- *Material:Nylon 66,UL94V-2 or UL94V-0
- *Suitable CJT C4201M series Terminal
- *Mates with CJT C4201HF series single row Housing
- *Color:Natural

Ordering Information:

- C4201HMA-XP - **
- | | |
|---|---|
| 1 | 2 |
|---|---|
- Part No.
 - Material:
(blank):UL94V-2 /Natural
V0:UL94V-0/White

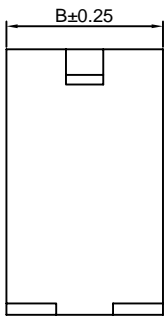
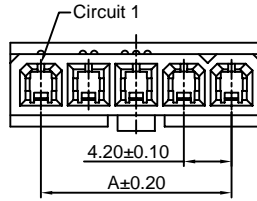
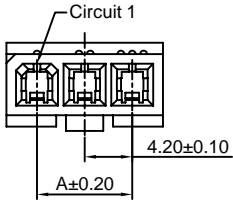
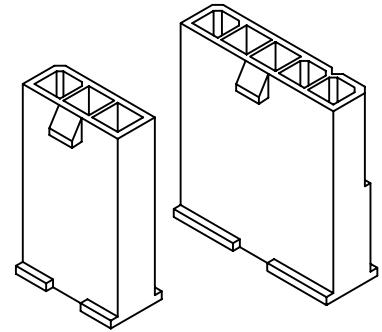

3P

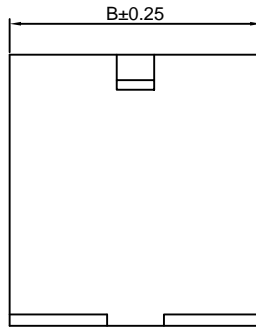

2P,4P,5P-12P

Ordering Information & Dimensions:

PART NO.	Dimensions	
	A	B
C4201HMA-2P	4.20	9.60
C4201HMA-3P	8.40	13.80
C4201HMA-4P	12.60	18.00
C4201HMA-5P	16.80	22.20
C4201HMA-6P	21.00	26.40
C4201HMA-7P	25.20	30.60
C4201HMA-8P	29.40	34.80
C4201HMA-9P	33.60	39.00
C4201HMA-10P	37.80	43.20
C4201HMA-11P	42.00	47.40
C4201HMA-12P	46.20	51.60

Unit: mm

C4201HF-2

4.20mm pitch Dual Row Housing

Reference Informations:

- *Material:Nylon 66,UL94V-2 or UL94V-0
- *Suitable CJT C4201F series Terminal
- *Mates with CJT C4201HM,C4201HMA series dual row Housing or C4201 series dual row Wafer
- *Color:Natural

Ordering Information:

- C4201HF-2xXP - **
- | | |
|---|---|
| 1 | 2 |
|---|---|
- Part No.
 - Material:
(blank):UL94V-2 /Natural
V0:UL94V-0/White

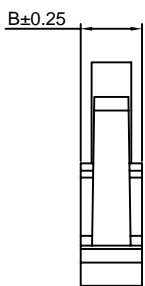
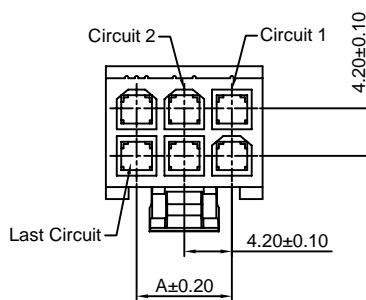
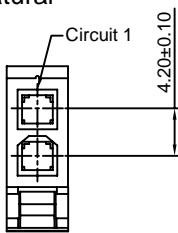
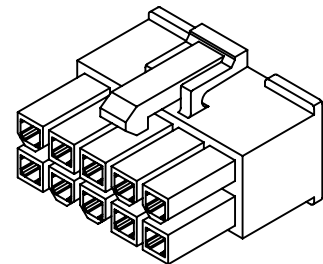

2x1P

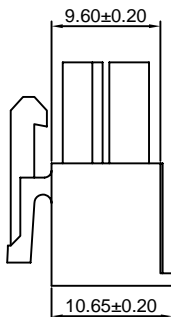

2x2P~2x12P

Ordering Information & Dimensions:

PART NO.	Dimensions	
	A	B
C4201HF-2x1P	-----	5.40
C4201HF-2x2P	4.20	9.60
C4201HF-2x3P	8.40	13.80
C4201HF-2x4P	12.60	18.00
C4201HF-2x5P	16.80	22.20
C4201HF-2x6P	21.00	26.40
C4201HF-2x7P	25.20	30.60
C4201HF-2x8P	29.40	34.80
C4201HF-2x9P	33.60	39.00
C4201HF-2x10P	37.80	43.20
C4201HF-2x11P	42.00	47.40
C4201HF-2x12P	46.20	51.60

Unit: mm



C4201 SERIES

4.20mm pitch wire to wire and wire to board connector

C4201HM-2

4.20mm pitch Dual Row Housing

Reference Informations:

- *Material:Nylon 66,UL94V-2 or UL94V-0
- *Suitable CJT C4201M series Terminal
- *Mates with CJT C4201HF series dual row Housing
- *Color:Natural

Ordering Information:

C4201HM-2xXP - **
1 2

- 1.Part No.
- 2.Material:
(blank):UL94V-2 /Natural
V0:UL94V-0/White

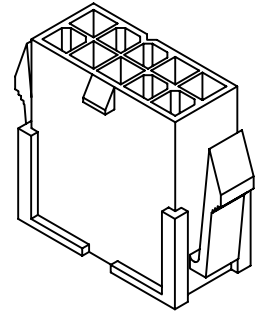
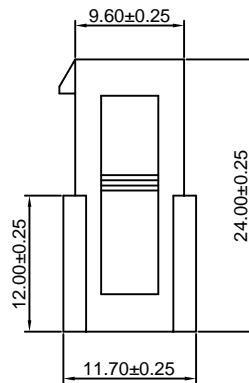
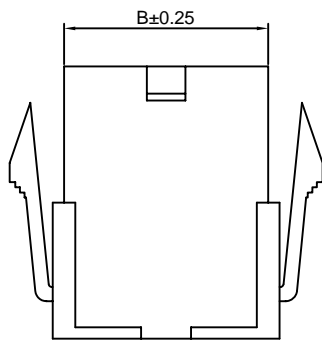
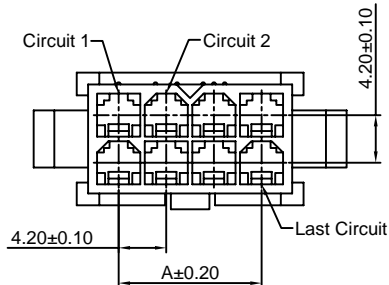

Ordering Information & Dimensions:

PART NO.	Dimensions	
	A	B
C4201HM-2x1P	-----	5.40
C4201HM-2x2P	4.20	9.60
C4201HM-2x3P	8.40	13.80
C4201HM-2x4P	12.60	18.00
C4201HM-2x5P	16.80	22.20
C4201HM-2x6P	21.00	26.40
C4201HM-2x7P	25.20	30.60
C4201HM-2x8P	29.40	34.80
C4201HM-2x9P	33.60	39.00
C4201HM-2x10P	37.80	43.20
C4201HM-2x11P	42.00	47.40
C4201HM-2x12P	46.20	51.60

Unit: mm

C4201HM-2-A

4.20mm pitch Dual Row Housing

Reference Informations:

- *Material:Nylon 66,UL94V-2 or UL94V-0
- *Suitable CJT C4201M series Terminal
- *Mates with CJT C4201HF series dual row Housing
- *Color:Natural

Ordering Information:

C4201HM-2xXP - **
1 2

- 1.Part No.
- 2.Material:
(blank):UL94V-2 /Natural
V0:UL94V-0/White

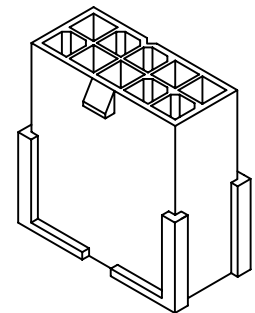
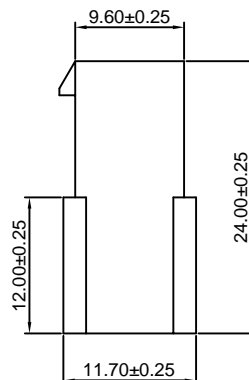
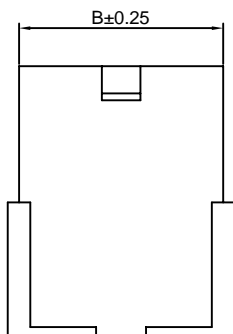
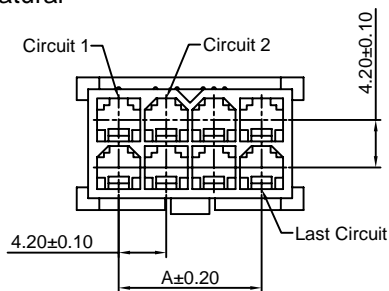

Ordering Information & Dimensions:

PART NO.	Dimensions	
	A	B
C4201HM-2x1P-A	-----	5.40
C4201HM-2x2P-A	4.20	9.60
C4201HM-2x3P-A	8.40	13.80
C4201HM-2x4P-A	12.60	18.00
C4201HM-2x5P-A	16.80	22.20
C4201HM-2x6P-A	21.00	26.40
C4201HM-2x7P-A	25.20	30.60
C4201HM-2x8P-A	29.40	34.80
C4201HM-2x9P-A	33.60	39.00
C4201HM-2x10P-A	37.80	43.20
C4201HM-2x11P-A	42.00	47.40
C4201HM-2x12P-A	46.20	51.60

Unit: mm



C4201 SERIES

4.20mm pitch wire to wire and wire to board connector

C4201HMA-2

4.20mm pitch Dual Row Housing - Without Mounting Ears

Reference Informations:

- *Material:Nylon 66,UL94V-2 or UL94V-0
- *Suitable CJT C4201M series Terminal
- *Mates with CJT C4201HM series dual row Housing
- *Color:Natural

Ordering Information:
C4201HMA-2xXP - **

- 1.Part No.
- 2.Material:
(blank):UL94V-2 /Natural
V0:UL94V-0/White

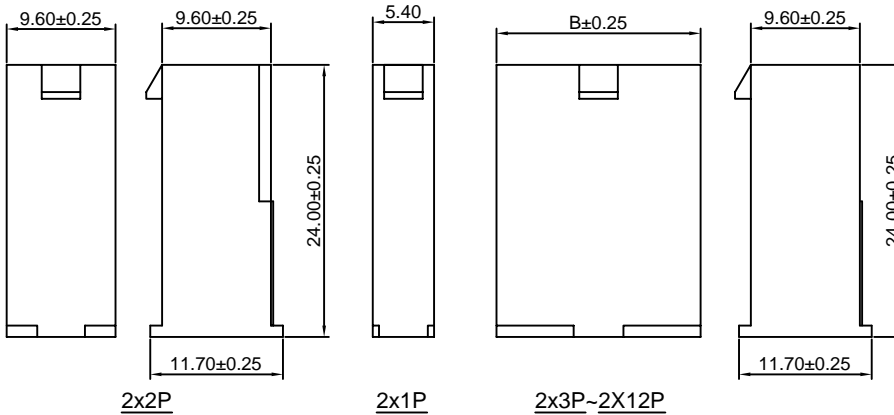
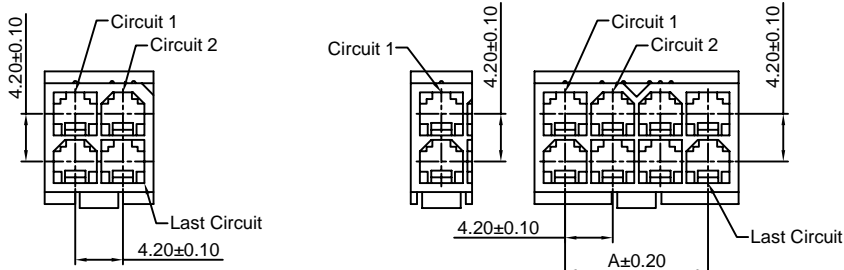
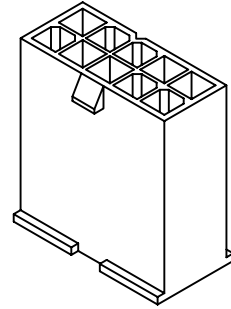

Ordering Information & Dimensions:

PART NO.	Dimensions	
	A	B
C4201HMA-2x1P	-----	5.40
C4201HMA-2x2P	4.20	9.60
C4201HMA-2x3P	8.40	13.80
C4201HMA-2x4P	12.60	18.00
C4201HMA-2x5P	16.80	22.20
C4201HMA-2x6P	21.00	26.40
C4201HMA-2x7P	25.20	30.60
C4201HMA-2x8P	29.40	34.80
C4201HMA-2x9P	33.60	39.00
C4201HMA-2x10P	37.80	43.20
C4201HMA-2x11P	42.00	47.40
C4201HMA-2x12P	46.20	51.60

Unit: mm

C4201WV

4.20mm pitch 180° Single Row Wafer

Reference Informations:

- *Material:Pin:Brass/Tin over Nickel
Insulator:Nylon 66,UL94V-2 or UL94V-0
- *Mates with CJT C4201 series single row Housing
- *Color:Natural

Ordering Information:
C4201WV-XP - **

- 1.Part No.
- 2.Material:
(blank):UL94V-2 /Natural
V0:UL94V-0/White

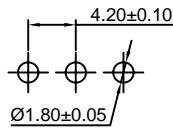
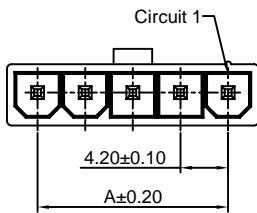

P.C.B LAYOUT

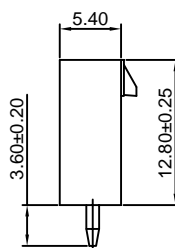
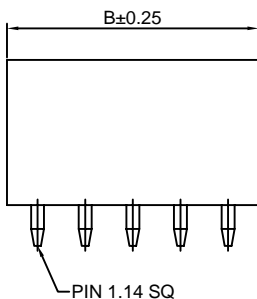
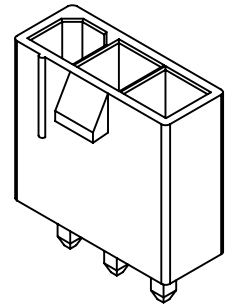

Ordering Information & Dimensions:

PART NO.	Dimensions	
	A	B
C4201WV-2P	4.20	9.60
C4201WV-3P	8.40	13.80
C4201WV-4P	12.60	18.00
C4201WV-5P	16.80	22.20
C4201WV-6P	21.00	26.40
C4201WV-7P	25.20	30.60
C4201WV-8P	29.40	34.80
C4201WV-9P	33.60	39.00
C4201WV-10P	37.80	43.20
C4201WV-11P	42.00	47.40
C4201WV-12P	46.20	51.60

Unit: mm



C4201 SERIES

4.20mm pitch wire to wire and wire to board connector

C4201WVA

4.20mm pitch 180° Single Row Wafer With Pegs

Reference Informations:

- *Material:Pin:Brass/Tin over Nickel
Insulator:Nylon 66,UL94V-2 or UL94V-0
- *Mates with CJT C4201HF series single row Housing
- *Color:Natural

Ordering Information:
C4201WVA-F-XP - **
1 2

- 1.Part No.
- 2.Material:
(blank):UL94V-2 /Natural
V0:UL94V-0/White

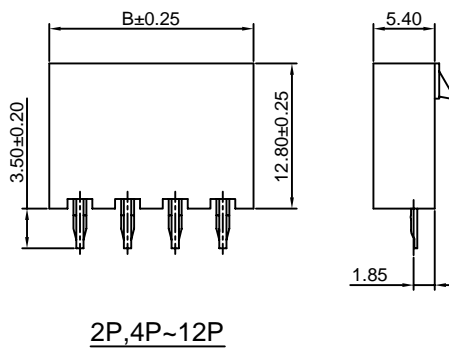
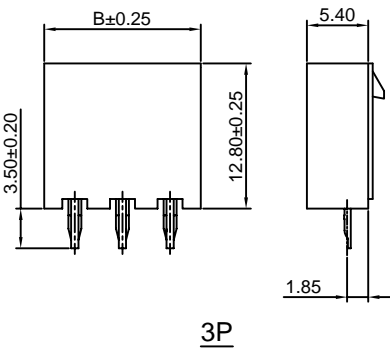
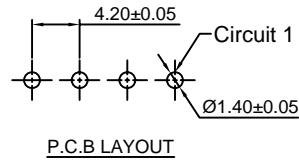
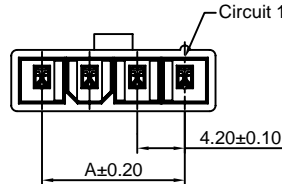
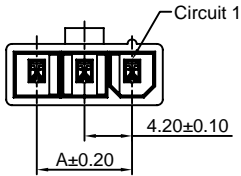
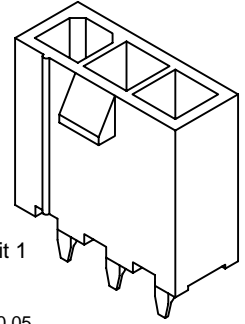

Ordering Information & Dimensions:

PART NO.	Dimensions	
	A	B
C4201WVA-2P	4.20	9.60
C4201WVA-3P	8.40	13.80
C4201WVA-4P	12.60	18.00
C4201WVA-5P	16.80	22.20
C4201WVA-6P	21.00	26.40
C4201WVA-7P	25.20	30.60
C4201WVA-8P	29.40	34.80
C4201WVA-9P	33.60	39.00
C4201WVA-10P	37.80	43.20
C4201WVA-11P	42.00	47.40
C4201WVA-12P	46.20	51.60

Unit: mm

C4201WVA-F

4.20mm pitch 180° Single Row Wafer With Pegs

Reference Informations:

- *Material:Pin:Brass/Tin over Nickel
Insulator:Nylon 66,UL94V-2 or UL94V-0
- *Mates with CJT C4201HF series single row Housing
- *Color:Natural

Ordering Information:
C4201WVA-F-XP - **
1 2

- 1.Part No.
- 2.Material:
(blank):UL94V-2 /Natural
V0:UL94V-0/White

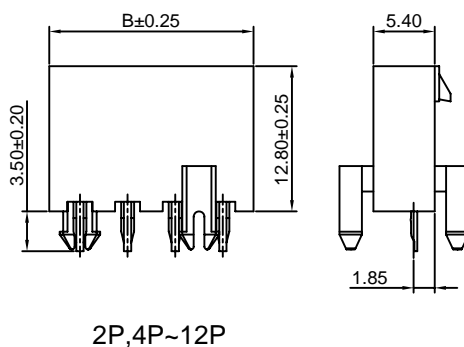
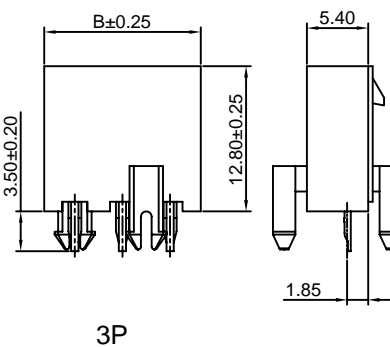
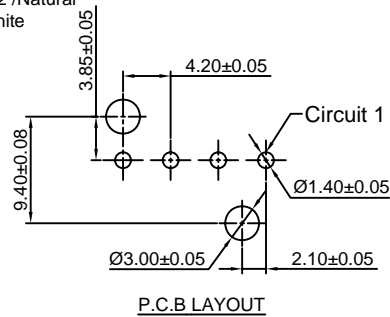
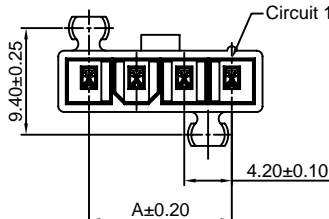
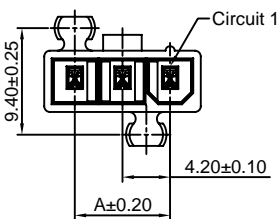
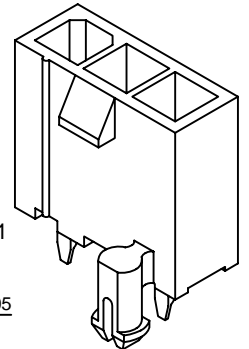

Ordering Information & Dimensions:

PART NO.	Dimensions	
	A	B
C4201WVA-F-2P	4.20	9.60
C4201WVA-F-3P	8.40	13.80
C4201WVA-F-4P	12.60	18.00
C4201WVA-F-5P	16.80	22.20
C4201WVA-F-6P	21.00	26.40
C4201WVA-F-7P	25.20	30.60
C4201WVA-F-8P	29.40	34.80
C4201WVA-F-9P	33.60	39.00
C4201WVA-F-10P	37.80	43.20
C4201WVA-F-11P	42.00	47.40
C4201WVA-F-12P	46.20	51.60

Unit: mm



C4201 SERIES

4.20mm pitch wire to wire and wire to board connector

C4201WR

4.20mm pitch 90° Single Row Wafer

Reference Informations:

- *Material:Pin:Brass/Tin over Nickel
Insulator:Nylon 66,UL94V-2 or UL94V-0
- *Mates with CJT C4201HF series single row Housing
- *Color:Natural

Ordering Information:

- C4201WR-XP - **
1 2
- 1.Part No.
 - 2.Material:
(blank):UL94V-2 /Natural
V0:UL94V-0/White

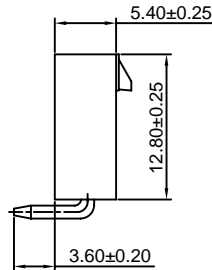
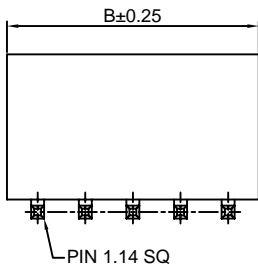
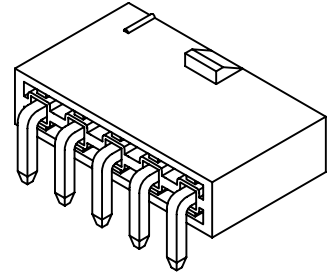
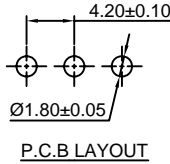
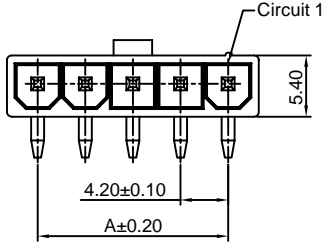

Ordering Information & Dimensions:

PART NO.	Dimensions	
	A	B
C4201WR-2P	4.20	9.60
C4201WR-3P	8.40	13.80
C4201WR-4P	12.60	18.00
C4201WR-5P	16.80	22.20
C4201WR-6P	21.00	26.40
C4201WR-7P	25.20	30.60
C4201WR-8P	29.40	34.80
C4201WR-9P	33.60	39.00
C4201WR-10P	37.80	43.20
C4201WR-11P	42.00	47.40
C4201WR-12P	46.20	51.60

Unit: mm

C4201WR-E

4.20mm pitch 90° Single Row Wafer With Ear

Reference Informations:

- *Material:Pin:Brass/Tin over Nickel
Insulator:Nylon 66,UL94V-2 or UL94V-0
- *Mates with CJT C4201HF series single row Housing
- *Color:Natural

Ordering Information:

- C4201WR-E-XP - **
1 2
- 1.Part No.
 - 2.Material:
(blank):UL94V-2 /Natural
V0:UL94V-0/White

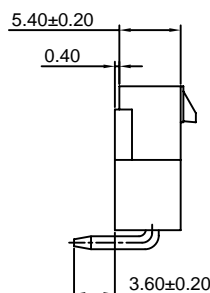
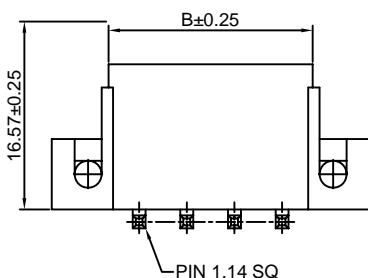
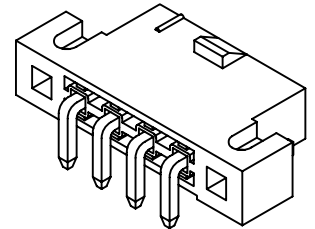
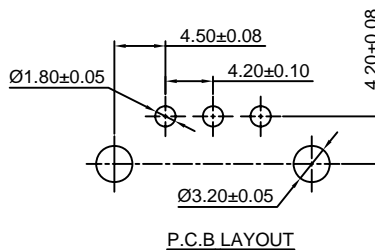
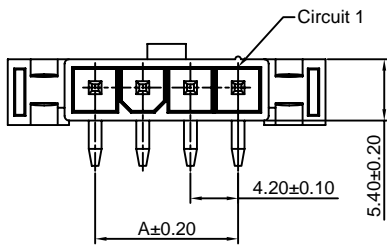

Ordering Information & Dimensions:

PART NO.	Dimensions	
	A	B
C4201WR-E-2P	4.20	9.60
C4201WR-E-3P	8.40	13.80
C4201WR-E-4P	12.60	18.00
C4201WR-E-5P	16.80	22.20
C4201WR-E-6P	21.00	26.40
C4201WR-E-7P	25.20	30.60
C4201WR-E-8P	29.40	34.80
C4201WR-E-9P	33.60	39.00
C4201WR-E-10P	37.80	43.20
C4201WR-E-11P	42.00	47.40
C4201WR-E-12P	46.20	51.60

Unit: mm



C4201 SERIES

4.20mm pitch wire to wire and wire to board connector

C4201WR-F

4.20mm pitch 90° Single Row Wafer With Pegs

Reference Informations:

- *Material:Pin:Brass/Tin over Nickel
Insulator:Nylon 66,UL94V-2 or UL94V-0
- *Mates with CJT C4201HF series single row Housing
- *Color:Natural

Ordering Information:
C4201WR-F-XP - **

- 1.Part No.
- 2.Material:
(blank):UL94V-2 /Natural
V0:UL94V-0/White

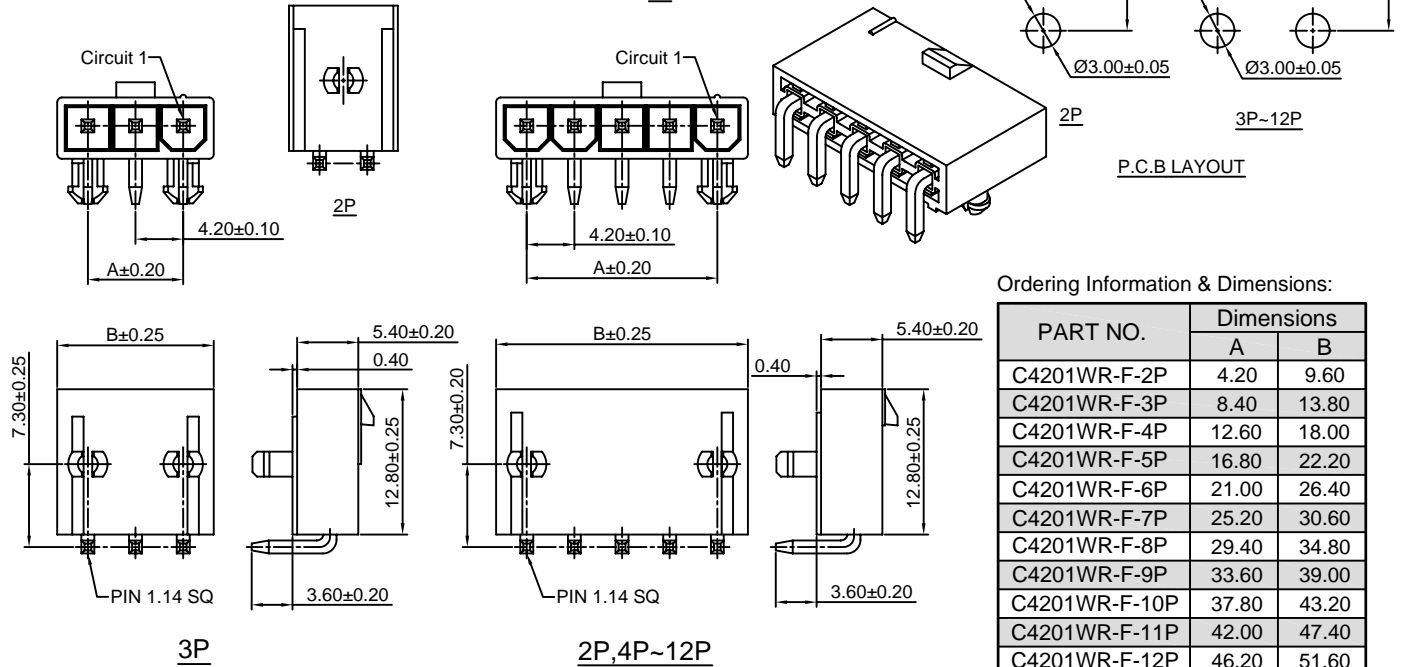

Ordering Information & Dimensions:

PART NO.	Dimensions	
	A	B
C4201WR-F-2P	4.20	9.60
C4201WR-F-3P	8.40	13.80
C4201WR-F-4P	12.60	18.00
C4201WR-F-5P	16.80	22.20
C4201WR-F-6P	21.00	26.40
C4201WR-F-7P	25.20	30.60
C4201WR-F-8P	29.40	34.80
C4201WR-F-9P	33.60	39.00
C4201WR-F-10P	37.80	43.20
C4201WR-F-11P	42.00	47.40
C4201WR-F-12P	46.20	51.60

Unit: mm

C4201WV-2

4.20mm pitch 180° Dual Row Wafer

Reference Informations:

- *Material:Pin:Brass/Tin over Nickel
Insulator:Nylon 66,UL94V-2 or UL94V-0
- *Mates with CJT C4201HF series dual row Housing
- *Color:Natural

Ordering Information:
C4201WV-2xXP - **

- 1.Part No.
- 2.Material:
(blank):UL94V-2/Natural
V0:UL94V-0/White

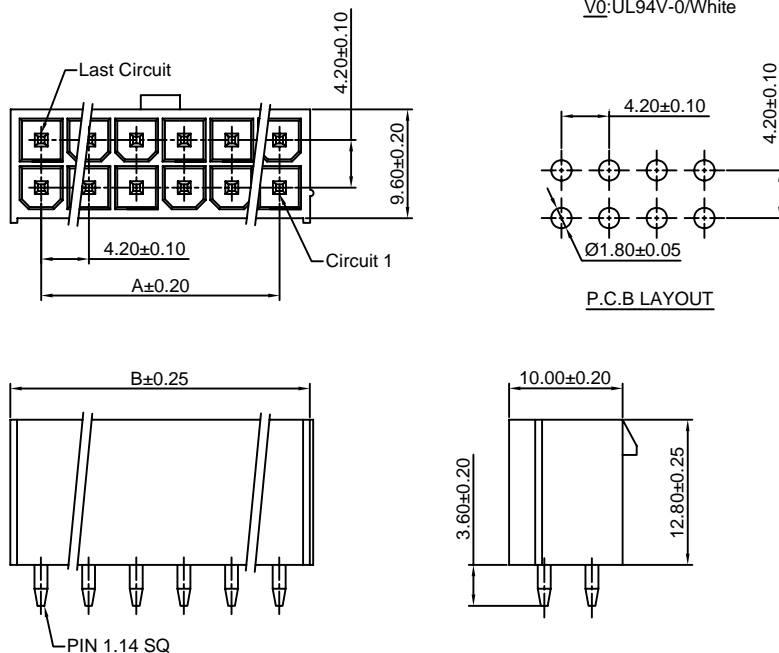

Ordering Information & Dimensions:

PART NO.	Dimensions	
	A	B
C4201WV-2x1P	-----	5.40
C4201WV-2x2P	4.20	9.60
C4201WV-2x3P	8.40	13.80
C4201WV-2x4P	12.60	18.00
C4201WV-2x5P	16.80	22.20
C4201WV-2x6P	21.00	26.40
C4201WV-2x7P	25.20	30.60
C4201WV-2x8P	29.40	34.80
C4201WV-2x9P	33.60	39.00
C4201WV-2x10P	37.80	43.20
C4201WV-2x11P	42.00	47.40
C4201WV-2x12P	46.20	51.60

Unit: mm



C4201 SERIES

4.20mm pitch wire to wire and wire to board connector

C4201WVA-2

4.20mm pitch 180° Dual Row Wafer

Reference Informations:

- *Material:Pin:Brass/Tin over Nickel
Insulator:Nylon 66,UL94V-2 or UL94V-0
- *Mates with CJT C4201HF series dual row Housing
- *Color:Natural

Ordering Information:
C4201WVA-2xXP - **
1 2

- 1.Part No.
- 2.Material:
(blank):UL94V-2/Natural
V0:UL94V-0/White

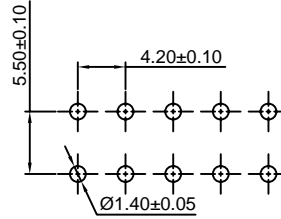
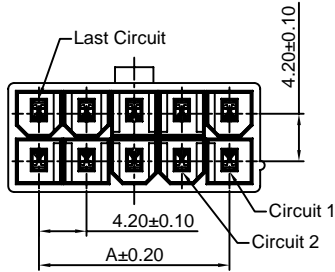

P.C.B LAYOUT

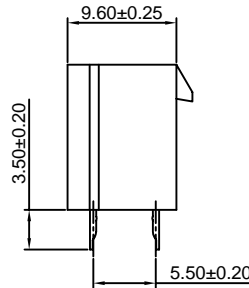
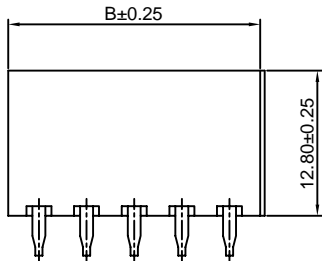
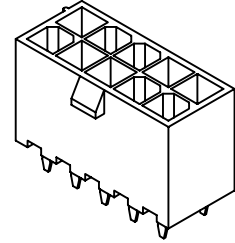

Ordering Information & Dimensions:

PART NO.	Dimensions	
	A	B
C4201WVA-2x1P	-----	5.40
C4201WVA-2x2P	4.20	9.60
C4201WVA-2x3P	8.40	13.80
C4201WVA-2x4P	12.60	18.00
C4201WVA-2x5P	16.80	22.20
C4201WVA-2x6P	21.00	26.40
C4201WVA-2x7P	25.20	30.60
C4201WVA-2x8P	29.40	34.80
C4201WVA-2x9P	33.60	39.00
C4201WVA-2x10P	37.80	43.20
C4201WVA-2x11P	42.00	47.40
C4201WVA-2x12P	46.20	51.60

Unit: mm

C4201WVA-F-2

4.20mm pitch 180° Dual Row Wafer With Foot

Reference Informations:

- *Material:Pin:Brass/Tin over Nickel
Insulator:Nylon 66,UL94V-2 or UL94V-0
- *Mates with CJT C4201HF series dual row Housing
- *Color:Natural

Ordering Information:
C4201WVA-F-2xXP - **
1 2

- 1.Part No.
- 2.Material:
(blank):UL94V-2/Natural
V0:UL94V-0/White

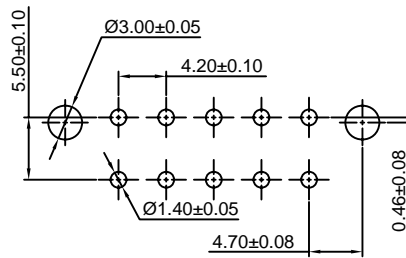
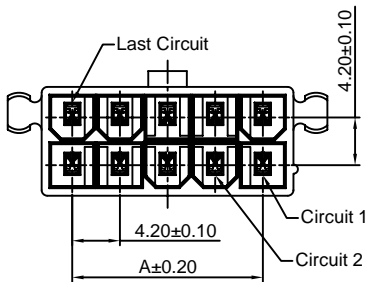

P.C.B LAYOUT

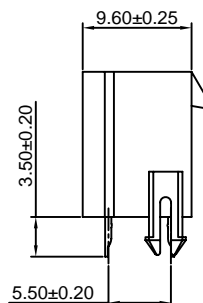
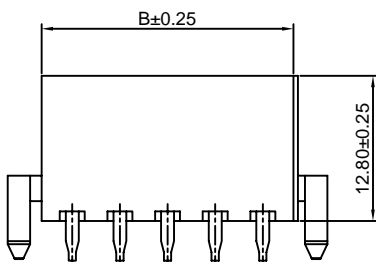
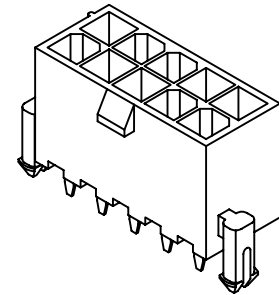

Ordering Information & Dimensions:

PART NO.	Dimensions	
	A	B
C4201WVA-F-2x1P	-----	5.40
C4201WVA-F-2x2P	4.20	9.60
C4201WVA-F-2x3P	8.40	13.80
C4201WVA-F-2x4P	12.60	18.00
C4201WVA-F-2x5P	16.80	22.20
C4201WVA-F-2x6P	21.00	26.40
C4201WVA-F-2x7P	25.20	30.60
C4201WVA-F-2x8P	29.40	34.80
C4201WVA-F-2x9P	33.60	39.00
C4201WVA-F-2x10P	37.80	43.20
C4201WVA-F-2x11P	42.00	47.40
C4201WVA-F-2x12P	46.20	51.60

Unit: mm



C4201 SERIES

4.20mm pitch wire to wire and wire to board connector

C4201WR-2

4.20mm pitch 90° Dual Row Wafer

Reference Informations:

- *Material:Pin:Brass/Tin over Nickel
Insulator:Nylon 66,UL94V-2 or UL94V-0
- *Mates with CJT C4201HF series dual row Housing
- *Color:Natural

Ordering Information:
C4201WR-2xXP - **
1 2
1.Part No.
2.Material:
(blank):UL94V-2/Natural
V0:UL94V-0/White

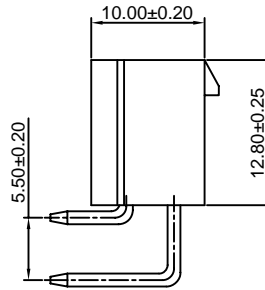
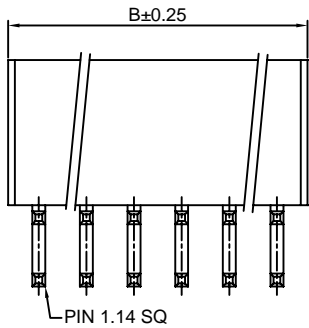
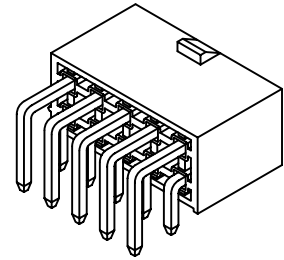
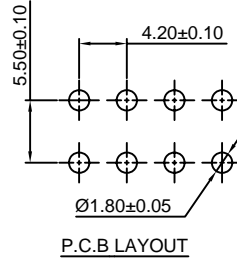
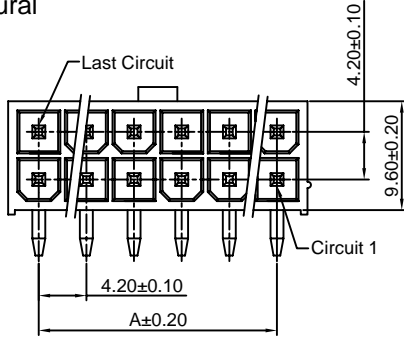

Ordering Information & Dimensions:

PART NO.	Dimensions	
	A	B
C4201WR-2x1P	-----	5.40
C4201WR-2x2P	4.20	9.60
C4201WR-2x3P	8.40	13.80
C4201WR-2x4P	12.60	18.00
C4201WR-2x5P	16.80	22.20
C4201WR-2x6P	21.00	26.40
C4201WR-2x7P	25.20	30.60
C4201WR-2x8P	29.40	34.80
C4201WR-2x9P	33.60	39.00
C4201WR-2x10P	37.80	43.20
C4201WR-2x11P	42.00	47.40
C4201WR-2x12P	46.20	51.60

Unit: mm

C4201WR-E-2

4.20mm pitch 180° Dual Row Wafer With Ear

Reference Informations:

- *Material:Pin:Brass/Tin over Nickel
Insulator:Nylon 66,UL94V-2 or UL94V-0
- *Mates with CJT C4201HF series dual row Housing
- *Color:Natural

Ordering Information:
C4201WR-E-2xXP - **
1 2
1.Part No.
2.Material:
(blank):UL94V-2/Natural
V0:UL94V-0/White

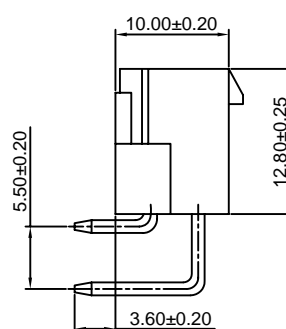
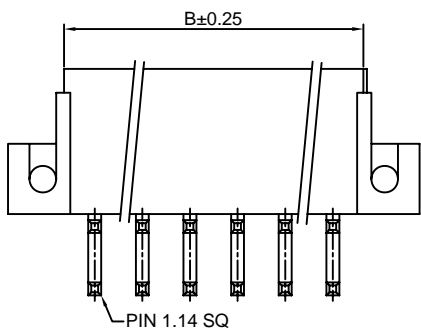
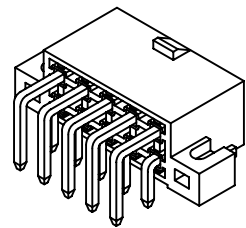
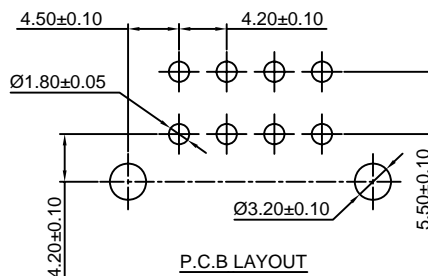
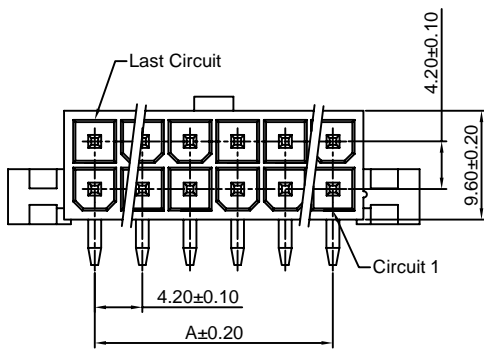

Ordering Information & Dimensions:

PART NO.	Dimensions	
	A	B
C4201WR-E-2x1P	-----	5.40
C4201WR-E-2x2P	4.20	9.60
C4201WR-E-2x3P	8.40	13.80
C4201WR-E-2x4P	12.60	18.00
C4201WR-E-2x5P	16.80	22.20
C4201WR-E-2x6P	21.00	26.40
C4201WR-E-2x7P	25.20	30.60
C4201WR-E-2x8P	29.40	34.80
C4201WR-E-2x9P	33.60	39.00
C4201WR-E-2x10P	37.80	43.20
C4201WR-E-2x11P	42.00	47.40
C4201WR-E-2x12P	46.20	51.60

Unit: mm



C4201 SERIES

4.20mm pitch wire to wire and wire to board connector

C4201WR-F-2

4.20mm pitch 90° Dual Row Wafer With Foot

Reference Informations:

- *Material: Pin: Brass/Tin over Nickel
Insulator: Nylon 66, UL94V-2 or UL94V-0
- *Mates with CJT C4201HF series dual row Housing
- *Color: Natural

Ordering Information:
C4201WR-F-2xXP - **
1 2

1. Part No.
2. Material:
(blank): UL94V-2/Natural
V0: UL94V-0/White

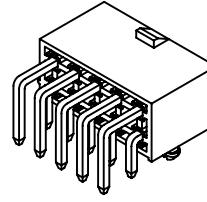
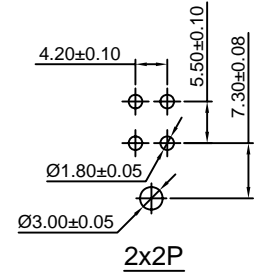
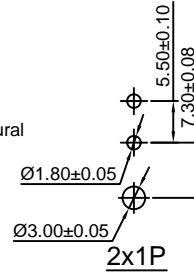
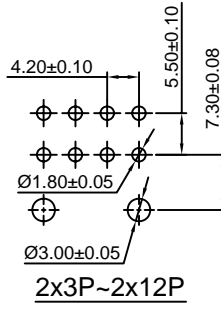
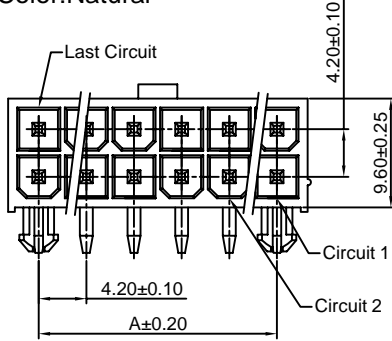

Ordering Information & Dimensions:

PART NO.	Dimensions	
	A	B
C4201WR-F-2x1P	-----	5.40
C4201WR-F-2x2P	4.20	9.60
C4201WR-F-2x3P	8.40	13.80
C4201WR-F-2x4P	12.60	18.00
C4201WR-F-2x5P	16.80	22.20
C4201WR-F-2x6P	21.00	26.40
C4201WR-F-2x7P	25.20	30.60
C4201WR-F-2x8P	29.40	34.80
C4201WR-F-2x9P	33.60	39.00
C4201WR-F-2x10P	37.80	43.20
C4201WR-F-2x11P	42.00	47.40
C4201WR-F-2x12P	46.20	51.60

Unit: mm

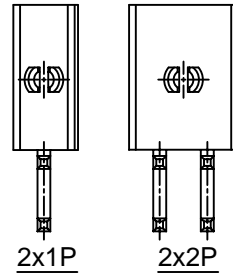
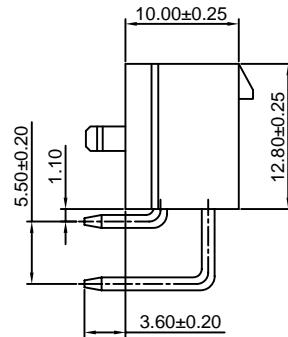
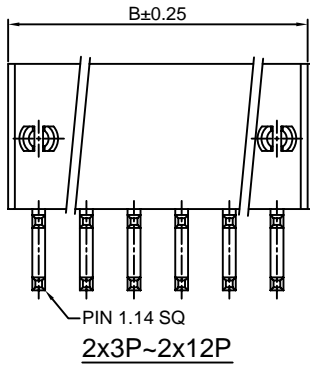

C4201HF-2x3P-A/B

4.20mm pitch Dual Row Housing - Special Type

Reference Informations:

- *Material: Nylon 66, UL94V-2 or UL94V-0
- *Suitable CJT C4201F series Terminal
- *Mates with CJT C4201HM or C4201WW special type series dual row Housing or Wafer
- *Color: Black

Ordering Information:
C4201HF-2x3P - **
1 2

1. Part No.
2. Material:
(blank): UL94V-2/Black
V0: UL94V-0/Black

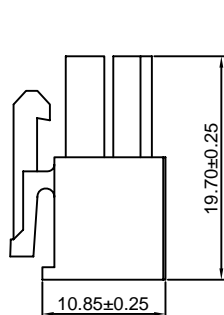
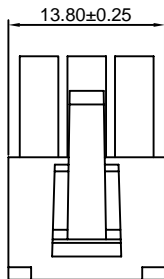
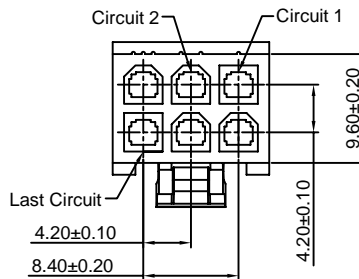
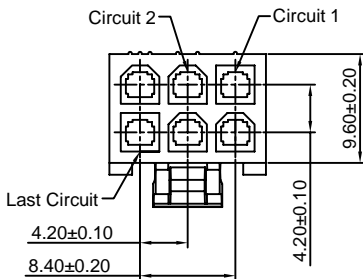
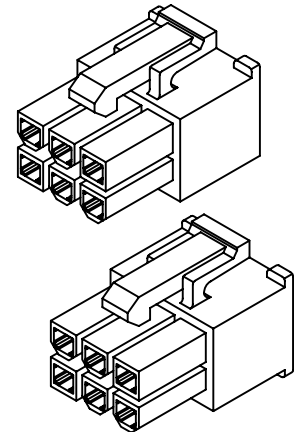

C4201HF-2x3P-A

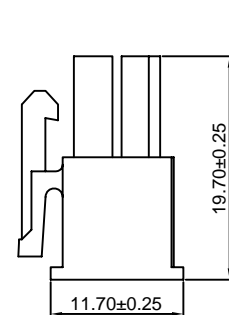
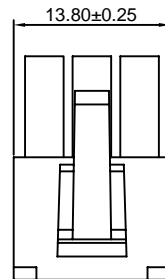

C4201HF-2x3P-B

Unit: mm



C4201 SERIES

4.20mm pitch wire to wire and wire to board connector

C4201WV-2x4P-A/B

4.20mm pitch Dual Row Housing - Special Type

Reference Informations:

- *Material: Pin: Brass/Tin over Nickel
Insulator: Nylon 66, UL94V-2 or UL94V-0
- *Mates with CJT C4201HF special type series dual row Housing
- *Color: Black

Ordering Information:

- C4201WV-2x4P - **
- | | |
|------------------------|---|
| 1 | 2 |
| 1. Part No. | |
| 2. Material: | |
| (blank): UL94V-2/Black | |
| V0: UL94V-0/Black | |

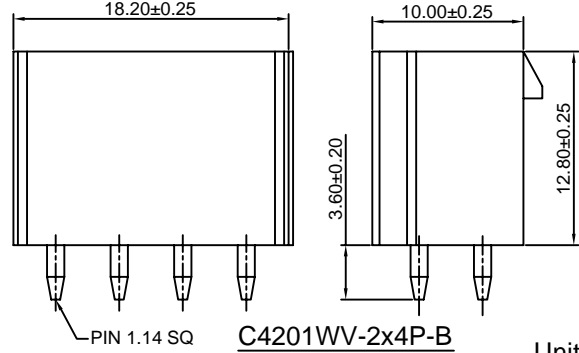
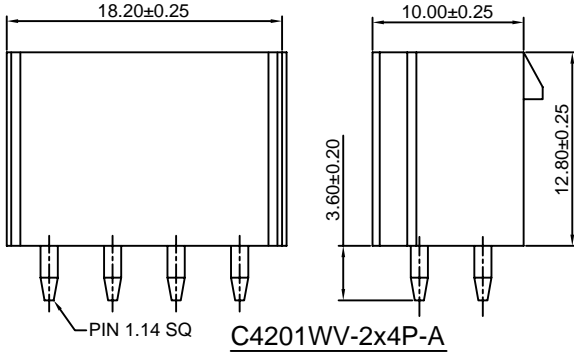
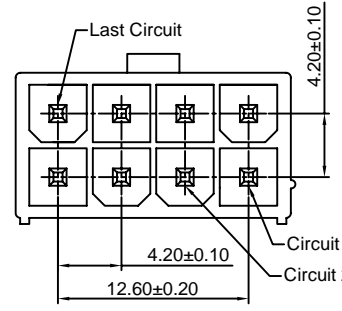
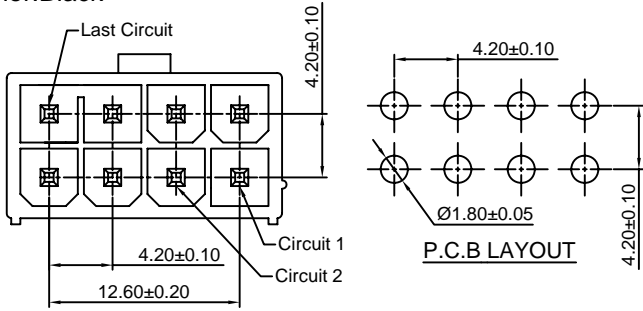
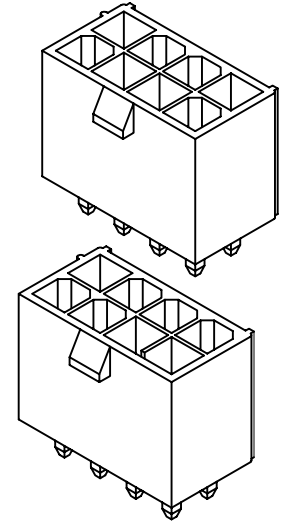

Unit: mm

C4201WR-F-2x3P-A

4.20mm pitch 90° Dual Row Wafer With Foot - Special TYPE

Reference Informations:

- *Material: Pin: Brass/Tin over Nickel
Insulator: Nylon 66, UL94V-2 or UL94V-0
- *Mates with CJT C4201HF-2x3P-B special type series dual row Housing
- *Color: Black

Ordering Information:

- C4201WR-F-2x3P-A - **
- | | |
|------------------------|---|
| 1 | 2 |
| 1. Part No. | |
| 2. Material: | |
| (blank): UL94V-2/Black | |
| V0: UL94V-0/Black | |

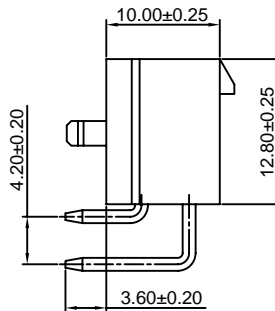
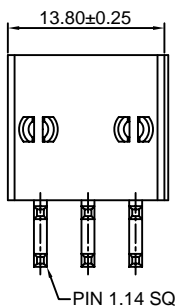
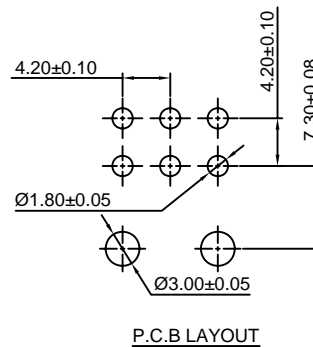
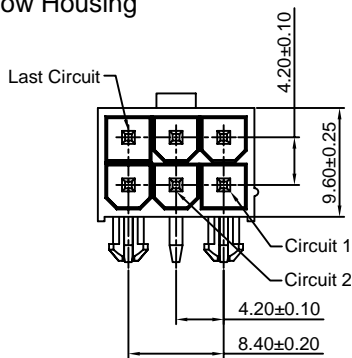
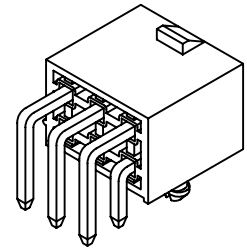

Unit: mm



C4201 SERIES

4.20mm pitch wire to wire and wire to board connector

C4201HFA-2

4.20mm Pitch Dual Row With Panel Mount Ears Housing

Reference Informations:

- *Material:Nylon 66,UL94V-2 or UL94V-0
- *Suitable CJT C4201F series Terminal
- *Mates with CJT C4201HMB series dual row Housing or C4201WVA-F1,C4201WR-F1 series dual row Wafer
- *Color:Natural

Ordering Information:
C4201HFA-2xXP - **
1 2

1.Part No.
2.Material:
(blank):UL94V-2/Natural
V0:UL94V-0/White

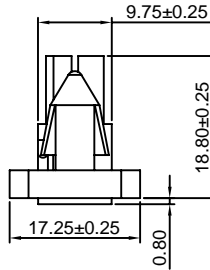
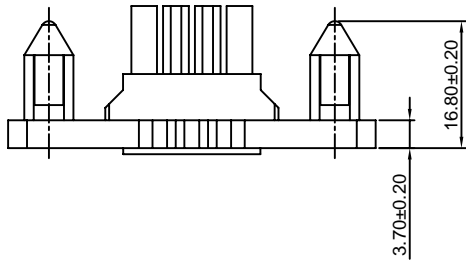
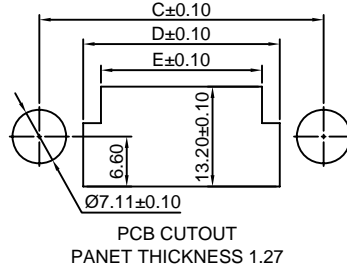
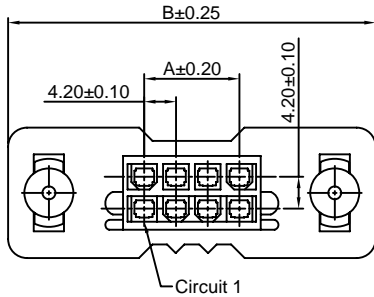
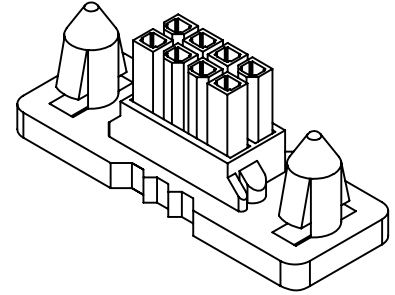

Ordering Information & Dimensions:

PART NO.	Dimensions				
	A	B	C	D	E
C4201HFA-2x1P	-----	36.00	25.00	13.20	8.70
C4201HFA-2x2P	4.20	40.20	29.20	17.60	12.90
C4201HFA-2x3P	8.40	44.40	33.40	21.80	17.10
C4201HFA-2x4P	12.60	48.60	37.60	26.00	21.30
C4201HFA-2x5P	16.80	52.80	41.80	30.20	25.50
C4201HFA-2x6P	21.00	57.00	46.00	34.40	29.70
C4201HFA-2x7P	25.20	61.20	50.20	38.60	33.90
C4201HFA-2x8P	29.40	65.40	54.40	42.80	38.10
C4201HFA-2x9P	33.60	69.60	58.60	47.00	42.30
C4201HFA-2x10P	37.80	73.80	62.80	51.20	46.50
C4201HFA-2x11P	42.00	78.00	67.00	55.40	50.70
C4201HFA-2x12P	46.20	82.20	71.20	59.60	54.90
C4201HFA-2x18P	71.40	107.40	96.40	81.50	76.78

Unit: mm

C4201HV-2

4.20mm Pitch Vertical Dual Row Receptacle Header

Reference Informations:

- *Material:Nylon 66,UL94V-2 or UL94V-0
- *Mates with CJT C4201HMB series dual row Housing or C4201WVA-F1,C4201WR-F1 series dual row Wafer
- *Color:Natural

Ordering Information:
C4201HV-2xXP - **
1 2

1.Part No.
2.Material:
(blank):UL94V-2/Natural
V0:UL94V-0/White

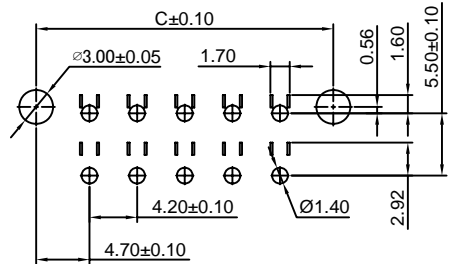

PCB LAYOUT:Component Side
Recommended PCB Thickness 1.78MAX

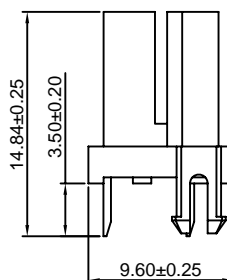
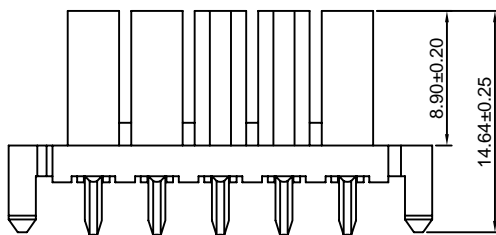
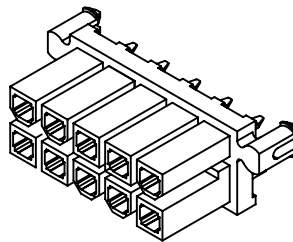
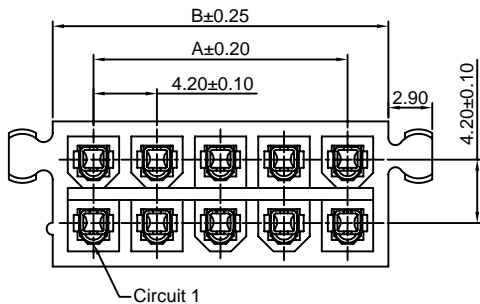

Ordering Information & Dimensions:

PART NO.	Dimensions		
	A	B	C
C4201HV-2x1P	-----	5.40	9.40
C4201HV-2x2P	4.20	9.60	13.60
C4201HV-2x3P	8.40	13.80	17.80
C4201HV-2x4P	12.60	18.00	22.00
C4201HV-2x5P	16.80	22.20	26.20
C4201HV-2x6P	21.00	26.40	30.40
C4201HV-2x7P	25.20	30.60	34.60
C4201HV-2x8P	29.40	34.80	38.80
C4201HV-2x9P	33.60	39.00	43.00
C4201HV-2x10P	37.80	43.20	47.20
C4201HV-2x11P	42.00	47.40	51.40
C4201HV-2x12P	46.20	51.60	55.60
C4201HV-2x18P	71.40	76.80	80.80

Unit: mm



C4201 SERIES

4.20mm pitch wire to wire and wire to board connector

C4201HMB-2

4.20mm Pitch Dual Row Housing With Panel Mount Ears

Reference Informations:

- *Material:Nylon 66,UL94V-2 or UL94V-0
- *Suitable CJT C4201M series Terminal
- *Mates with CJT C4201HFA series dual row Housing or C4201HV series dual row Header
- *Color:Natural

Ordering Information:
C4201HMB-2xXP - **
 1 2
 1.Part No.
 2.Material:
 (blank):UL94V-2/Natural
 V0:UL94V-0/White

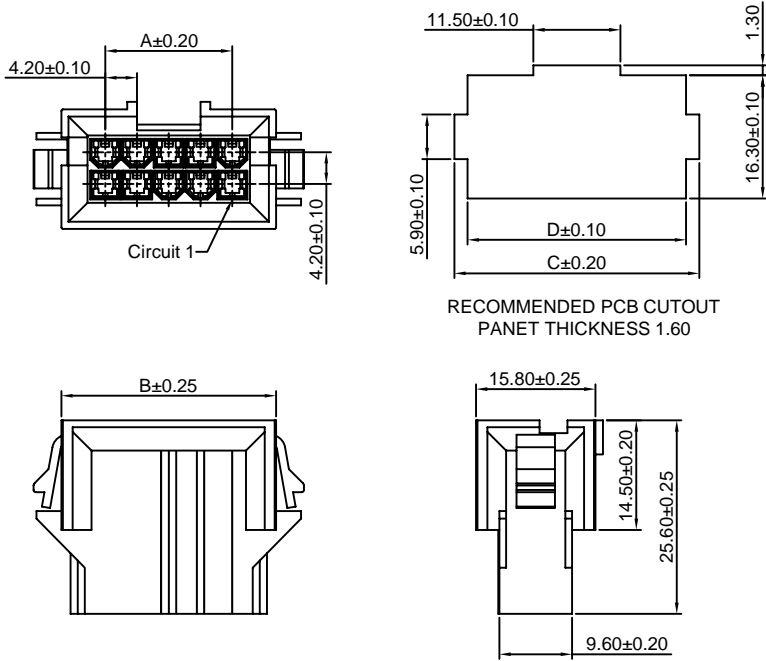
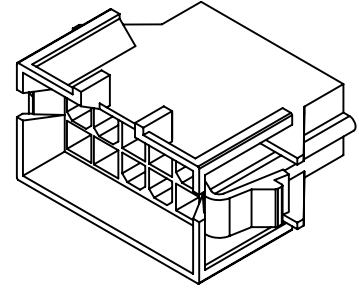

Ordering Information & Dimensions:

PART NO.	Dimensions			
	A	B	C	D
C4201HMB-2x1P	----	11.60	15.60	12.10
C4201HMB-2x2P	4.20	15.80	19.80	16.30
C4201HMB-2x3P	8.40	20.00	24.00	20.50
C4201HMB-2x4P	12.60	24.20	28.20	24.70
C4201HMB-2x5P	16.80	28.40	32.40	28.90
C4201HMB-2x6P	21.00	32.60	36.60	33.10
C4201HMB-2x7P	25.20	36.80	40.80	37.30
C4201HMB-2x8P	29.40	41.00	45.00	41.50
C4201HMB-2x9P	33.60	45.20	49.20	45.70
C4201HMB-2x10P	37.80	49.40	53.40	49.90
C4201HMB-2x11P	42.00	53.60	57.60	54.10
C4201HMB-2x12P	46.20	57.80	61.80	58.30
C4201HMB-2x18P	71.40	83.00	87.00	83.50

Unit: mm

C4201WVA-F1-2

4.20mm pitch 180° Dual Row Wafer With Foot

Reference Informations:

- *Material:Pin:Brass/Tin over Nickel
 Insulator:Nylon 66,UL94V-2 or UL94V-0
- *Mates with CJT C4201HFA, C4201HV series dual row Housing
- *Color:Natural

Ordering Information:
C4201WVA-F1-2xXP - **
 1 2
 1.Part No.
 2.Material:
 (blank):UL94V-2/Natural
 V0:UL94V-0/White

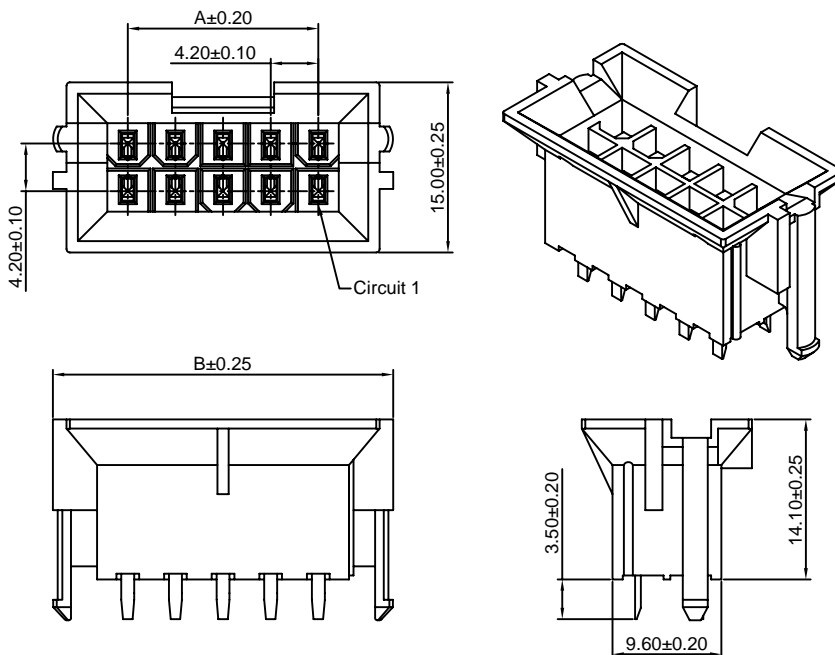
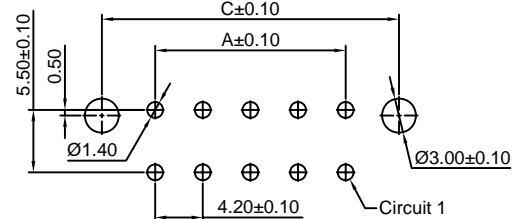

Ordering Information & Dimensions:

PART NO.	Dimensions		
	A	B	C
C4201WVA-F1-2x1P	----	13.20	9.40
C4201WVA-F1-2x2P	4.20	17.40	13.60
C4201WVA-F1-2x3P	8.40	21.60	17.80
C4201WVA-F1-2x4P	12.60	25.80	22.00
C4201WVA-F1-2x5P	16.80	30.00	26.20
C4201WVA-F1-2x6P	21.00	34.20	30.40
C4201WVA-F1-2x7P	25.20	38.40	34.60
C4201WVA-F1-2x8P	29.40	42.60	38.80
C4201WVA-F1-2x9P	33.60	46.80	43.00
C4201WVA-F1-2x10P	37.80	51.00	47.20
C4201WVA-F1-2x11P	42.00	55.20	51.40
C4201WVA-F1-2x12P	46.20	59.40	55.60
C4201WVA-F1-2x18P	71.40	84.60	80.80

Unit: mm



C4201 SERIES

4.20mm pitch wire to wire and wire to board connector

C4201WR-F1-2

4.20mm pitch 90° Dual Row Wafer With Foot

Reference Informations:

- *Material:Pin:Brass/Tin over Nickel
Insulator:Nylon 66,UL94V-2 or UL94V-0
- *Mates with CJT C4201HFA,C4201HV series dual row Housing
- *Color:Natural

Ordering Information:

C4201WR-F1-2xXP - **
1 2

- 1.Part No.
- 2.Material:
(blank):UL94V-2/Natural
V0:UL94V-0/White

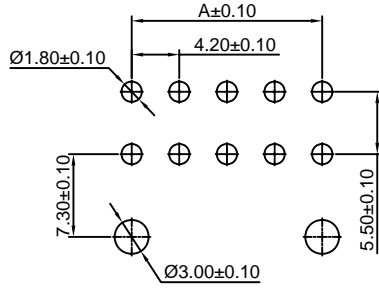
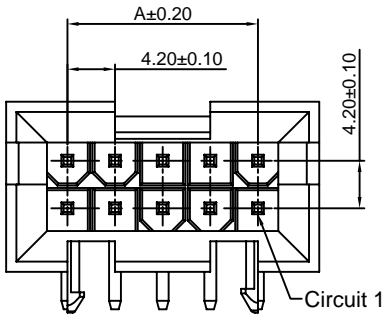
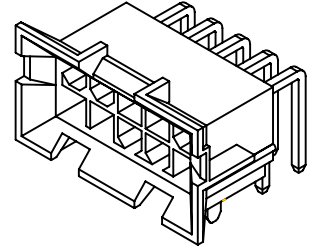

PCB LAYOUT:Component Side
Recommended PCB Thickness 1.78MAX

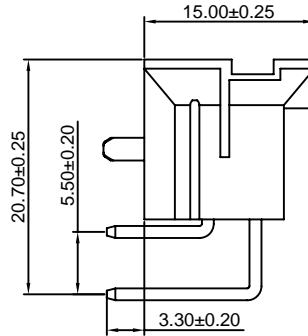
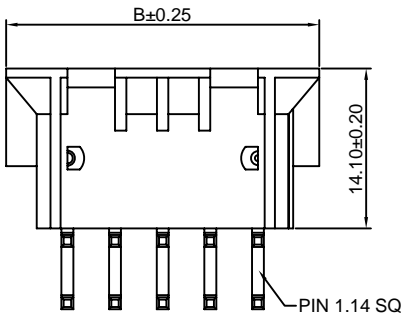

Ordering Information & Dimensions:

PART NO.	Dimensions	
	A	B
C4201WR-F1-2x1P	-----	10.80
C4201WR-F1-2x2P	4.20	15.00
C4201WR-F1-2x3P	8.40	19.20
C4201WR-F1-2x4P	12.60	23.40
C4201WR-F1-2x5P	16.80	27.60
C4201WR-F1-2x6P	21.00	31.80
C4201WR-F1-2x7P	25.20	36.00
C4201WR-F1-2x8P	29.40	40.20
C4201WR-F1-2x9P	33.60	44.40
C4201WR-F1-2x10P	37.80	48.60
C4201WR-F1-2x11P	42.00	52.80
C4201WR-F1-2x12P	46.20	57.00
C4201WR-F1-2x18P	71.40	82.20

Unit: mm

C4201WVB-2

4.20mm pitch 180° Dual Row Wafer With Foot

Reference Informations:

- *Material:Pin:Phosphor Bronze/Tin over Nickel
Insulator:Nylon 66,UL94V-0
- *Mates with CJT C4201HFA,C4201HV series dual row Housing
- *Color:Black

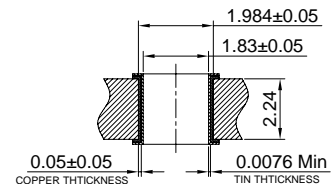
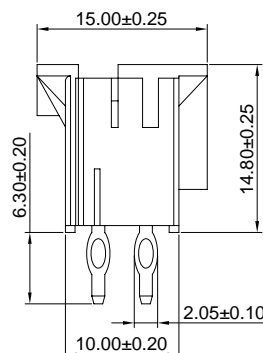
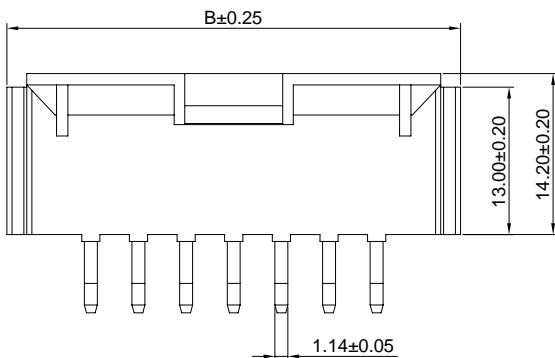
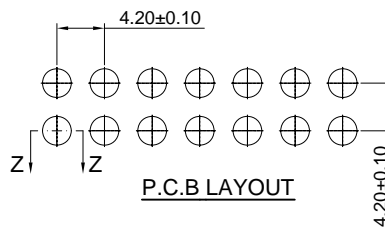
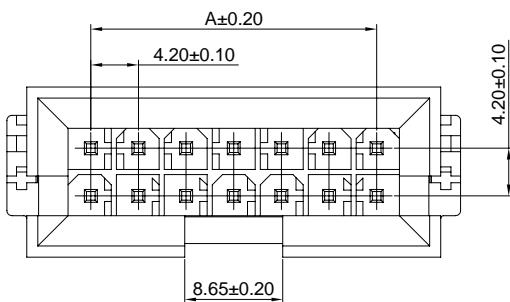
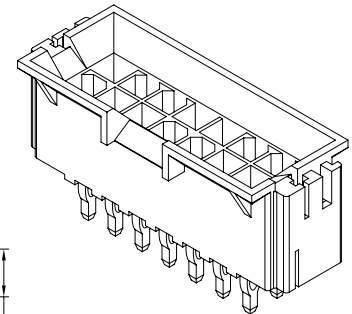

SEC:Z-Z

Ordering Information & Dimensions:

PART NO.	Dimensions	
	A	B
C4201WVB-2x7P	25.20	40.00
C4201WVB-2x9P	33.60	48.40
C4201WVB-2x12P	46.20	61.00

Unit: mm



C4201 SERIES

4.19mm pitch wire to board connector

C4201FS-T

4.19mm pitch Crimp Terminal

Reference Informations:

*Used in CJT C4201HFS C4201HFSB series Housing

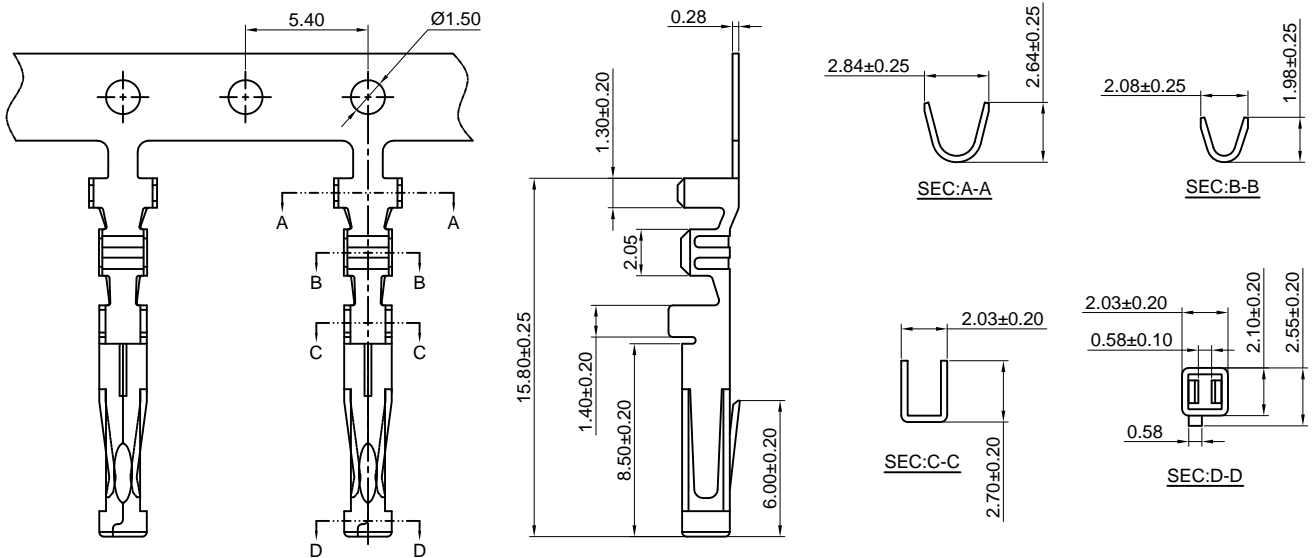

Ordering information & Specifications:

Unit:mm

Part NO	Wire Range	Insulation O.D.	Material	Finish	Qty/reel
C4201FS-TP	AWG#20-#24	1.75mm(max)	Phosphor Bronze	Tin over Nickel	10,000 PCS
C4201FS-GP	AWG#20-#24	1.75mm(max)	Phosphor Bronze	Gold over Nickel	10,000 PCS

Optional Gold plating available but MOQ requested

C4201FS-T-H

4.19mm pitch Crimp Terminal

Reference Informations:

*Used in CJT C4201HFS C4201HFSB series Housing

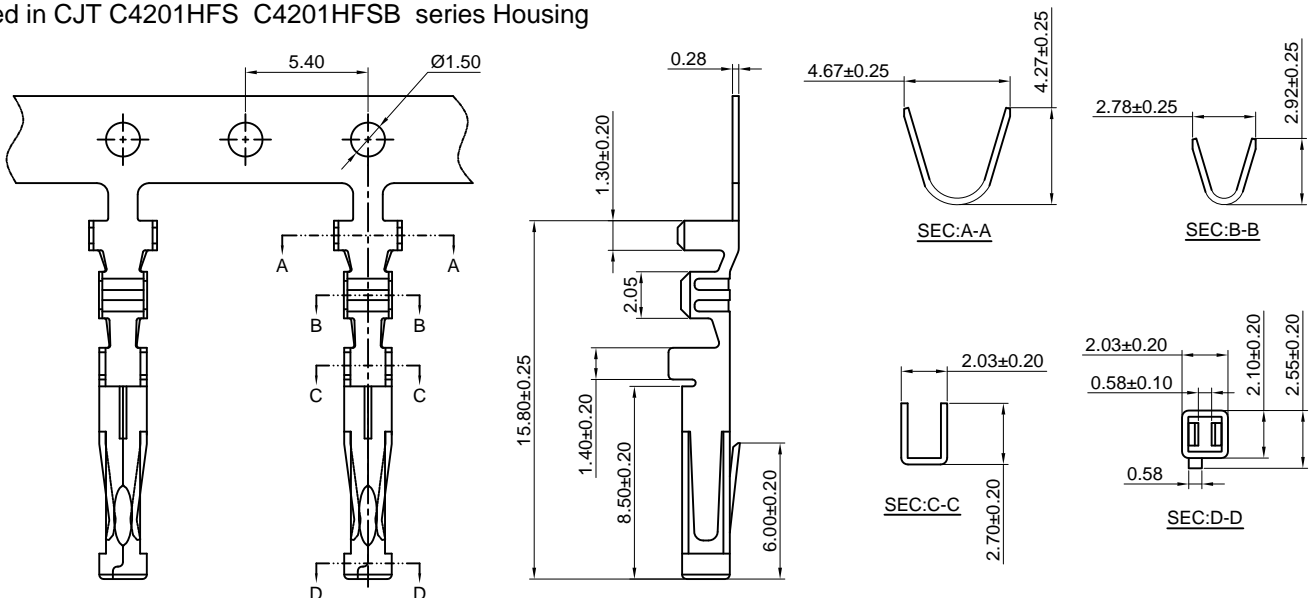

Ordering information & Specifications:

Unit:mm

Part NO	Wire Range	Insulation O.D.	Material	Finish	Qty/reel
C4201FS-TP-H	AWG#16-#20	3.12mm(max)	Phosphor Bronze	Tin over Nickel	10,000 PCS
C4201FS-GP-H	AWG#16-#20	3.12mm(max)	Phosphor Bronze	Gold over Nickel	10,000 PCS

Optional Gold plating available but MOQ requested



C4201 SERIES

4.19mm pitch wire to board connector

C4201FS-T-L

4.19mm pitch Crimp Terminal

Reference Informations:

*Used in CJT C4201HFS C4201HFSB series Housing

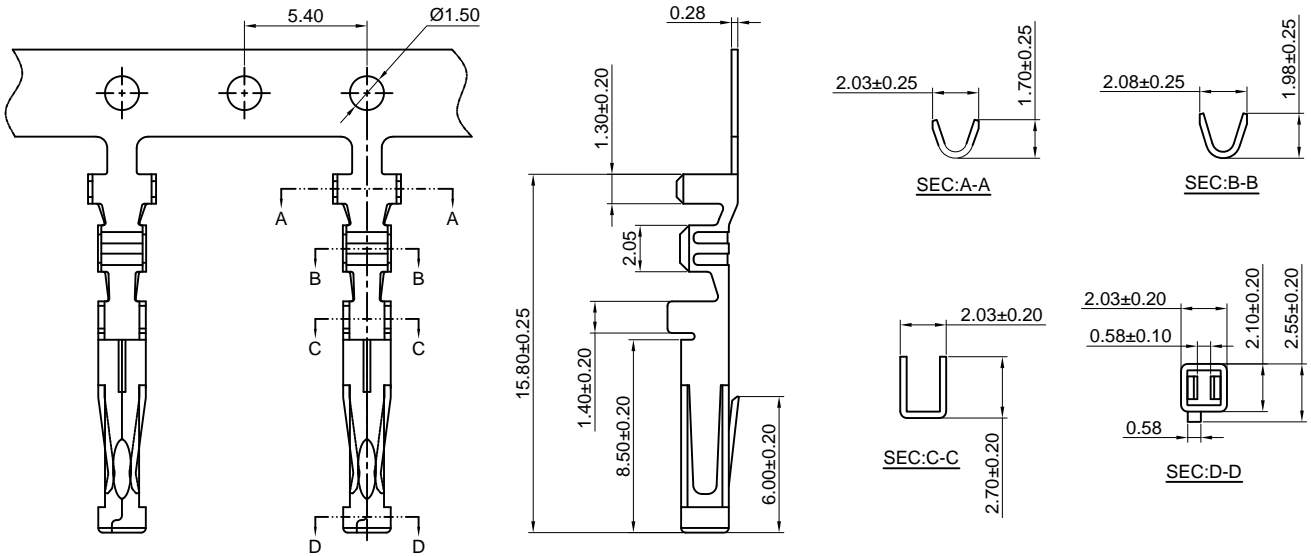

Ordering information & Specifications:

Unit:mm

Part NO	Wire Range	Insulation O.D.	Material	Finish	Qty/reel
C4201FS-TP-L	AWG#24-#26	1.50mm(max)	Phosphor Bronze	Tin over Nickel	10,000 PCS
C4201FS-GP-L	AWG#24-#26	1.50mm(max)	Phosphor Bronze	Gold over Nickel	10,000 PCS

Optional Gold plating available but MOQ requested

C4201HFS

4.19mm Pitch Single Row Housing

Reference Informations:

*Material:Nylon 66,UL94V-0

*Suitable CJT C4201FS-T series Terminal

*Mates with CJT C4201WVS , C4201WRS , C4201WVS-S

, C4201WRS-S series single row Wafer

*Color:Natural

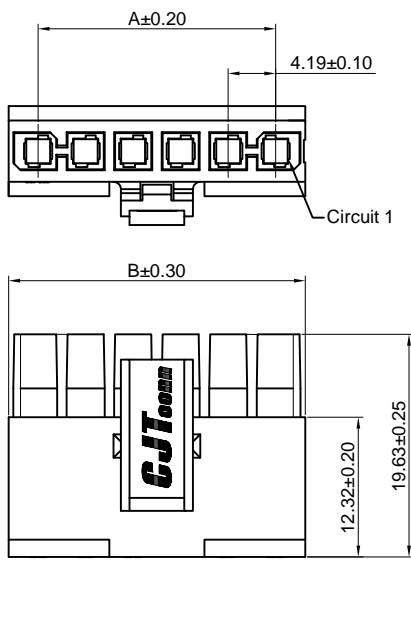

Ordering Information & Dimensions:

PART NO.	Dimensions	
	A	B
C4201HFS-2P	4.19	9.40
C4201HFS-3P	8.38	13.59
C4201HFS-4P	12.57	17.78
C4201HFS-5P	16.76	21.97
C4201HFS-6P	21.95	26.16
C4201HFS-7P	25.14	30.35
C4201HFS-8P	29.33	34.54
C4201HFS-9P	33.52	38.73
C4201HFS-10P	37.71	42.92
C4201HFS-11P	41.90	47.11
C4201HFS-12P	46.09	51.30
C4201HFS-13P	50.28	55.49
C4201HFS-14P	54.47	59.68
C4201HFS-15P	58.66	63.87

Unit: mm



C4201 SERIES

4.19mm pitch wire to board connector

C4201HFSB

4.19mm Pitch Single Row Housing

Reference Informations:

- *Material:Nylon 66,UL94V-0
- *Suitable CJT C4201FS-T series Terminal
- *Mates with CJT C4201WVSB , C4201WRSB , C4201WVSB-S , C4201WRSB-S series single row Wafer
- *Color:Natural

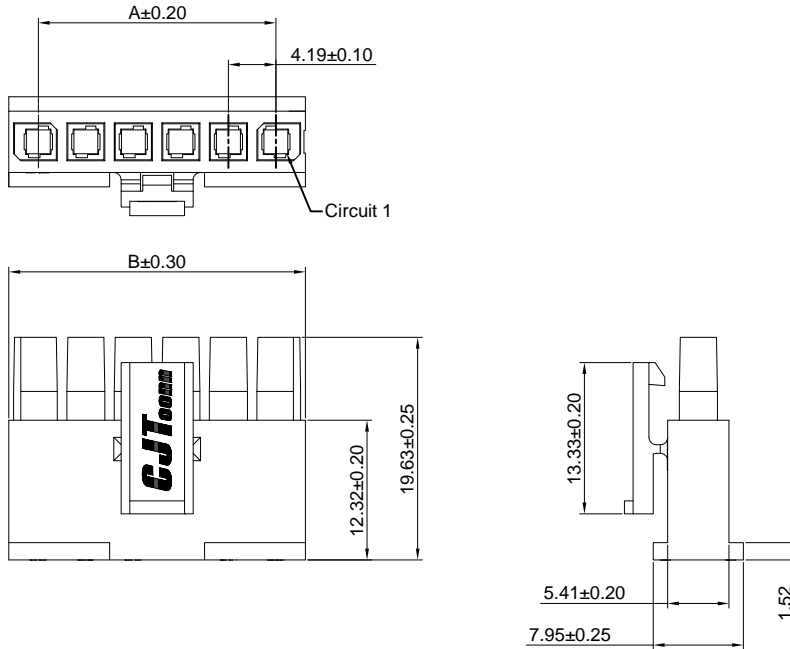

Ordering Information & Dimensions:

PART NO.	Dimensions	
	A	B
C4201HFSB-2P	4.19	9.40
C4201HFSB-3P	8.38	13.59
C4201HFSB-4P	12.57	17.78
C4201HFSB-5P	16.76	21.97
C4201HFSB-6P	21.95	26.16
C4201HFSB-7P	25.14	30.35
C4201HFSB-8P	29.33	34.54
C4201HFSB-9P	33.52	38.73
C4201HFSB-10P	37.71	42.92
C4201HFSB-11P	41.90	47.11
C4201HFSB-12P	46.09	51.30
C4201HFSB-13P	50.28	55.49
C4201HFSB-14P	54.47	59.68
C4201HFSB-15P	58.66	63.87

Unit: mm

C4201HFS-2

4.19mm Pitch Dual Row Housing

Reference Informations:

- *Material:Nylon 66,UL94V-0
- *Suitable CJT C4201FS-T series Terminal
- *Mates with CJT C4201WVS , C4201WRS , C4201WVS-S , C4201WRS-S series dual row Wafer
- *Color:Natural

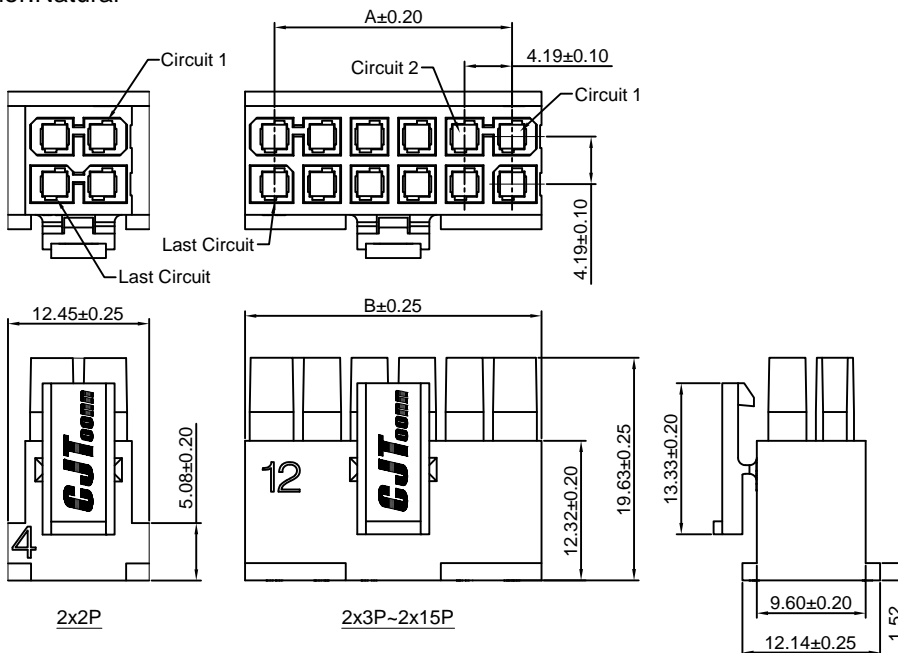

Ordering Information & Dimensions:

PART NO.	Dimensions	
	A	B
C4201HFS-2x2P	4.19	12.45
C4201HFS-2x3P	8.38	13.59
C4201HFS-2x4P	12.57	17.78
C4201HFS-2x5P	16.76	21.97
C4201HFS-2x6P	21.95	26.16
C4201HFS-2x7P	25.14	30.35
C4201HFS-2x8P	29.33	34.54
C4201HFS-2x9P	33.52	38.73
C4201HFS-2x10P	37.71	42.92
C4201HFS-2x11P	41.90	47.11
C4201HFS-2x12P	46.09	51.30
C4201HFS-2x13P	50.28	55.49
C4201HFS-2x14P	54.47	59.68
C4201HFS-2x15P	58.66	63.87

Unit: mm



C4201 SERIES

4.19mm pitch wire to board connector

C4201HFSB-2

4.19mm Pitch Dual Row Housing

Reference Informations:

- *Material:Nylon 66,UL94V-0
- *Suitable CJT C4201FS-T series Terminal
- *Mates with CJT C4201WVSB , C4201WRSB ,C4201WVSB-S , C4201WRSB-S series dual row Wafer
- *Color:Natural

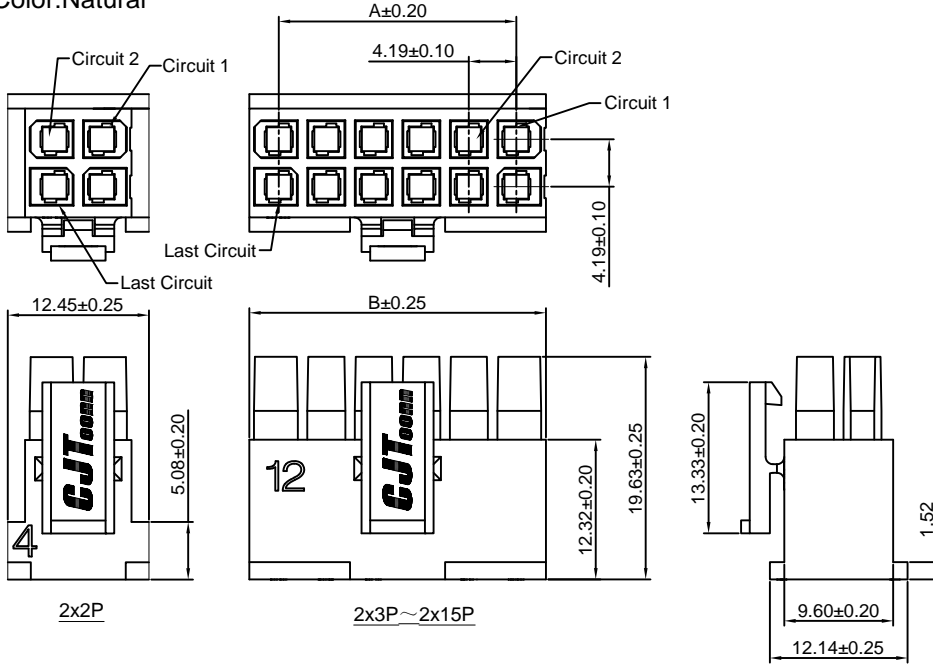

Ordering Information & Dimensions:

PART NO.	Dimensions	
	A	B
C4201HFSB-2x2P	4.19	12.45
C4201HFSB-2x3P	8.38	13.59
C4201HFSB-2x4P	12.57	17.78
C4201HFSB-2x5P	16.76	21.97
C4201HFSB-2x6P	21.95	26.16
C4201HFSB-2x7P	25.14	30.35
C4201HFSB-2x8P	29.33	34.54
C4201HFSB-2x9P	33.52	38.73
C4201HFSB-2x10P	37.71	42.92
C4201HFSB-2x11P	41.90	47.11
C4201HFSB-2x12P	46.09	51.30
C4201HFSB-2x13P	50.28	55.49
C4201HFSB-2x14P	54.47	59.68
C4201HFSB-2x15P	58.66	63.87

Unit: mm

C4201WVS

4.19mm pitch 180° Single Row Wafer

Reference Informations:

- *Material:Pin:Brass/Tin over Nickel
Insulator:LCP , UL94V-0
- *Suitable CJT C4201FS-T series Terminal
- *Mates with CJT C4201HFS series single row housing
- *Color:Black

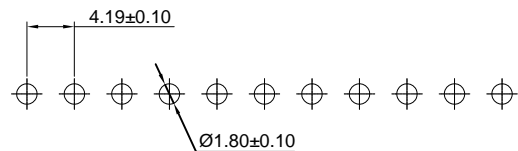

P.C.B LAYOUT

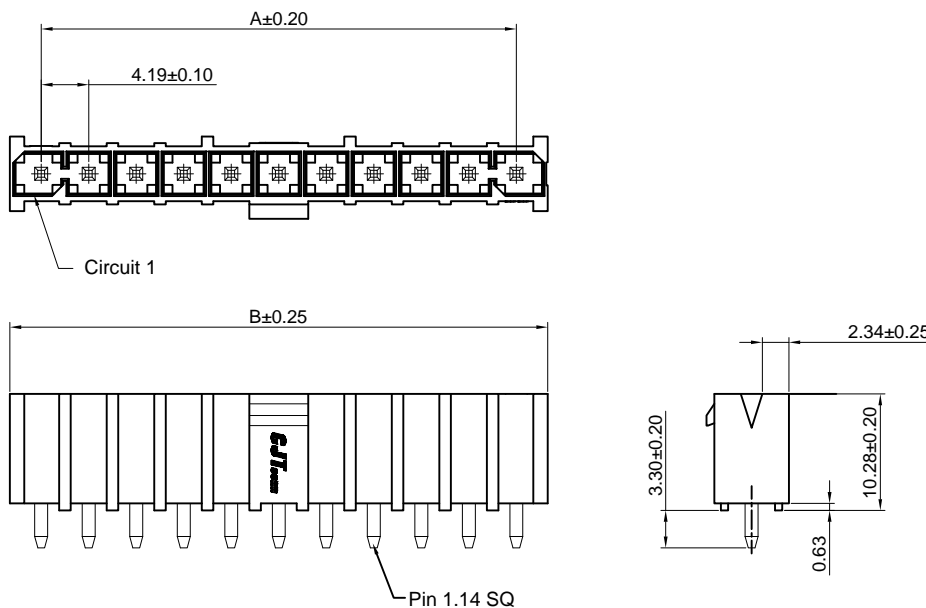

Ordering Information & Dimensions:

PART NO.	Dimensions	
	A	B
C4201WVS-2P	4.19	9.40
C4201WVS-3P	8.38	13.59
C4201WVS-4P	12.57	17.78
C4201WVS-5P	16.76	21.97
C4201WVS-6P	21.95	26.16
C4201WVS-7P	25.14	30.35
C4201WVS-8P	29.33	34.54
C4201WVS-9P	33.52	38.73
C4201WVS-10P	37.71	42.92
C4201WVS-11P	41.90	47.11
C4201WVS-12P	46.09	51.30
C4201WVS-13P	50.28	55.49
C4201WVS-14P	54.47	59.68
C4201WVS-15P	58.66	63.87

Unit: mm

CJT C4201 SERIES

4.19mm pitch wire to board connector

C4201WVSB

4.19mm pitch 180° Single Row Wafer

Reference Informations:

- *Material:Pin:Brass/Tin over Nickel
Insulator:LCP , UL94V-0
- *Suitable CJT C4201FS-T series Terminal
- *Mates with CJT C4201HFSB series single row housing
- *Color:Black

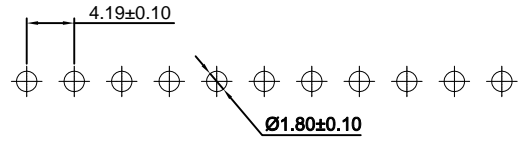
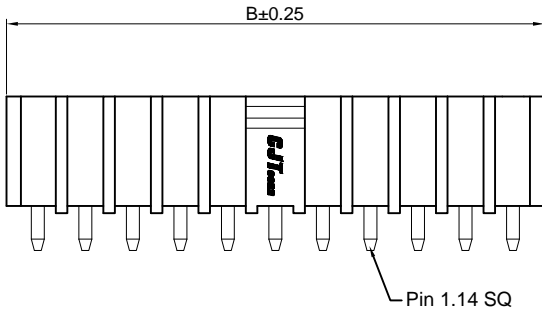
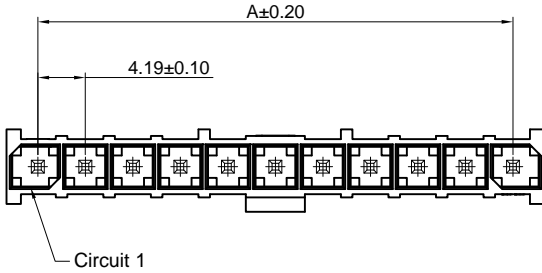

P.C.B LAYOUT

Ordering Information & Dimensions:

PART NO.	Dimensions	
	A	B
C4201WVSB-2P	4.19	9.40
C4201WVSB-3P	8.38	13.59
C4201WVSB-4P	12.57	17.78
C4201WVSB-5P	16.76	21.97
C4201WVSB-6P	21.95	26.16
C4201WVSB-7P	25.14	30.35
C4201WVSB-8P	29.33	34.54
C4201WVSB-9P	33.52	38.73
C4201WVSB-10P	37.71	42.92
C4201WVSB-11P	41.90	47.11
C4201WVSB-12P	46.09	51.30
C4201WVSB-13P	50.28	55.49
C4201WVSB-14P	54.47	59.68
C4201WVSB-15P	58.66	63.87

Unit: mm

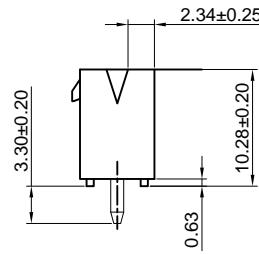

C4201WVS-S

4.19mm Pitch 180° Single Row Wafer-SMT TYPE

Reference Informations:

- *Material:Pin:Brass/Tin over Nickel
Insulator:LCP , UL94V-0
- *Suitable CJT C4201FS-T series Terminal
- *Mates with CJT C4201HFS series single row housing
- *Color:Black

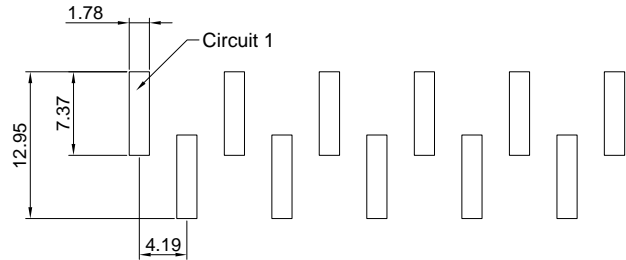
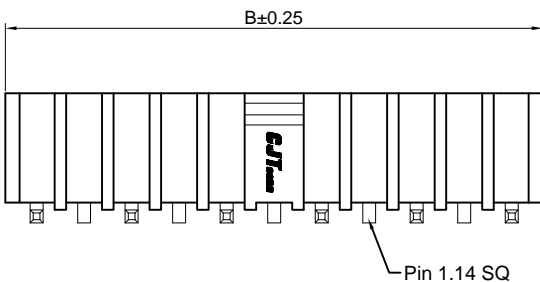
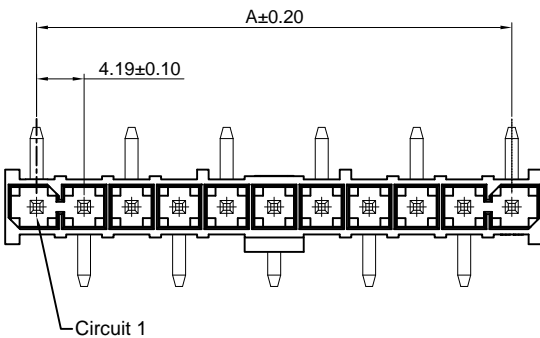

P.C.B LAYOUT

Ordering Information & Dimensions:

PART NO.	Dimensions	
	A	B
C4201WVS-S-2P	4.19	9.40
C4201WVS-S-3P	8.38	13.59
C4201WVS-S-4P	12.57	17.78
C4201WVS-S-5P	16.76	21.97
C4201WVS-S-6P	21.95	26.16
C4201WVS-S-7P	25.14	30.35
C4201WVS-S-8P	29.33	34.54
C4201WVS-S-9P	33.52	38.73
C4201WVS-S-10P	37.71	42.92
C4201WVS-S-11P	41.90	47.11
C4201WVS-S-12P	46.09	51.30
C4201WVS-S-13P	50.28	55.49
C4201WVS-S-14P	54.47	59.68
C4201WVS-S-15P	58.66	63.87

Unit: mm

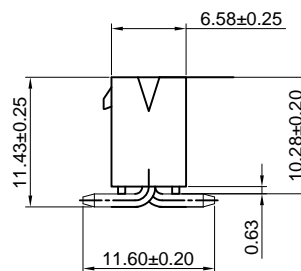



C4201 SERIES

4.19mm pitch wire to board connector

C4201WVSB-S

4.19mm Pitch 180° Single Row Wafer-SMT TYPE

Reference Informations:

- *Material:Pin:Brass/Tin over Nickel
Insulator:LCP , UL94V-0
- *Suitable CJT C4201FS-T series Terminal
- *Mates with CJT C4201HFSB series single row housing
- *Color:Black

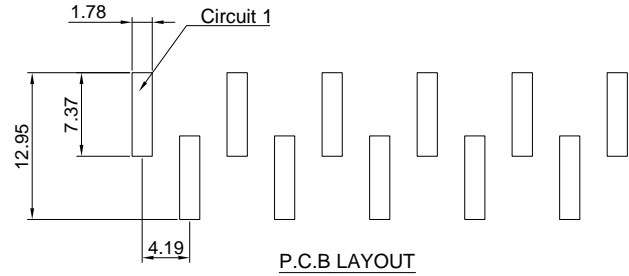
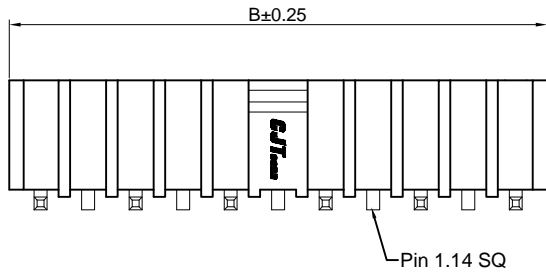
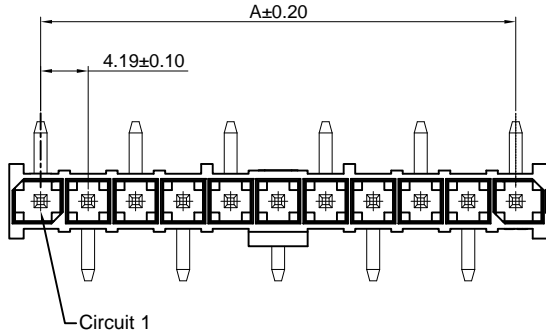

P.C.B LAYOUT

Ordering Information & Dimensions:

PART NO.	Dimensions	
	A	B
C4201WVSB-S-2P	4.19	9.40
C4201WVSB-S-3P	8.38	13.59
C4201WVSB-S-4P	12.57	17.78
C4201WVSB-S-5P	16.76	21.97
C4201WVSB-S-6P	21.95	26.16
C4201WVSB-S-7P	25.14	30.35
C4201WVSB-S-8P	29.33	34.54
C4201WVSB-S-9P	33.52	38.73
C4201WVSB-S-10P	37.71	42.92
C4201WVSB-S-11P	41.90	47.11
C4201WVSB-S-12P	46.09	51.30
C4201WVSB-S-13P	50.28	55.49
C4201WVSB-S-14P	54.47	59.68
C4201WVSB-S-15P	58.66	63.87

Unit: mm

C4201WRS

4.19mm pitch 90° Single Row Wafer

Reference Informations:

- *Material:Pin:Brass/Tin over Nickel
Insulator:LCP , UL94V-0
- *Suitable CJT C4201FS-T series Terminal
- *Mates with CJT C4201HFS series Single row housing
- *Color:Black

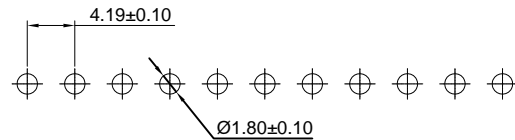
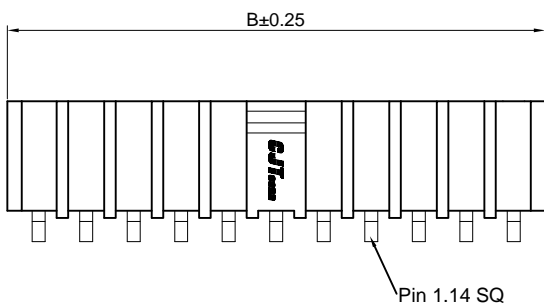
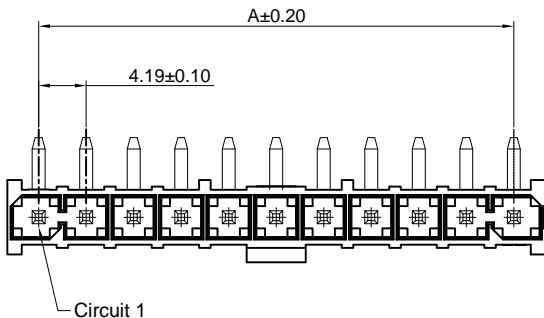

P.C.B LAYOUT

Ordering Information & Dimensions:

PART NO.	Dimensions	
	A	B
C4201WRS-2P	4.19	9.40
C4201WRS-3P	8.38	13.59
C4201WRS-4P	12.57	17.78
C4201WRS-5P	16.76	21.97
C4201WRS-6P	21.95	26.16
C4201WRS-7P	25.14	30.35
C4201WRS-8P	29.33	34.54
C4201WRS-9P	33.52	38.73
C4201WRS-10P	37.71	42.92
C4201WRS-11P	41.90	47.11
C4201WRS-12P	46.09	51.30
C4201WRS-13P	50.28	55.49
C4201WRS-14P	54.47	59.68
C4201WRS-15P	58.66	63.87

Unit: mm



C4201 SERIES

4.19mm pitch wire to board connector

C4201WRSB

4.19mm Pitch 90° Single Row Wafer

Reference Informations:

- *Material:Pin:Brass/Tin over Nickel
Insulator:LCP , UL94V-0
- *Suitable CJT C4201FS-T series Terminal
- *Mates with CJT C4201HFSB series single row housing
- *Color:Black

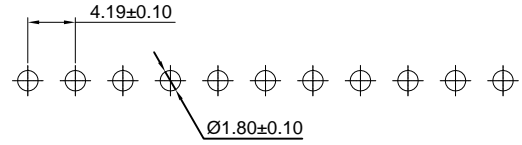
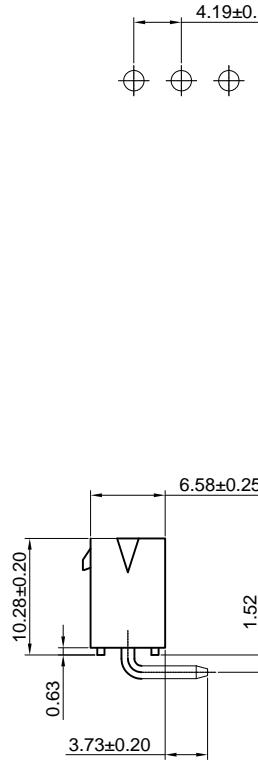
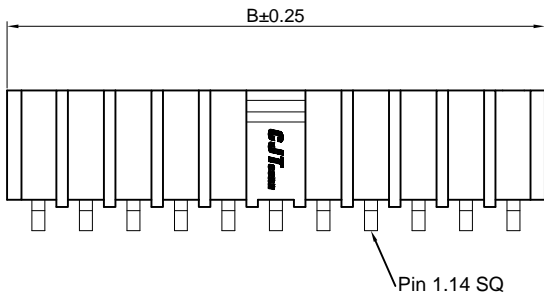
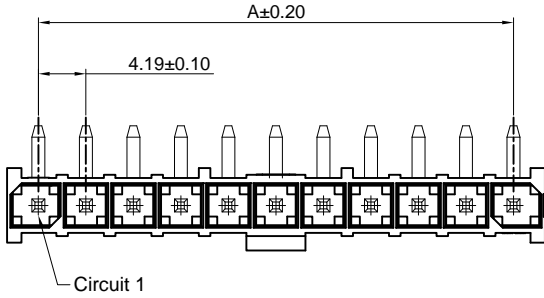

P.C.B LAYOUT

Ordering Information & Dimensions:

PART NO.	Dimensions	
	A	B
C4201WRSB-2P	4.19	9.40
C4201WRSB-3P	8.38	13.59
C4201WRSB-4P	12.57	17.78
C4201WRSB-5P	16.76	21.97
C4201WRSB-6P	21.95	26.16
C4201WRSB-7P	25.14	30.35
C4201WRSB-8P	29.33	34.54
C4201WRSB-9P	33.52	38.73
C4201WRSB-10P	37.71	42.92
C4201WRSB-11P	41.90	47.11
C4201WRSB-12P	46.09	51.30
C4201WRSB-13P	50.28	55.49
C4201WRSB-14P	54.47	59.68
C4201WRSB-15P	58.66	63.87

Unit: mm

C4201WVS-2

4.19mm pitch 180° Dual Row Wafer

Reference Informations:

- *Material:Pin:Brass/Tin over Nickel
Insulator:LCP , UL94V-0
- *Suitable CJT C4201FS-T series Terminal
- *Mates with CJT C4201HFS series dual row housing
- *Color:Black

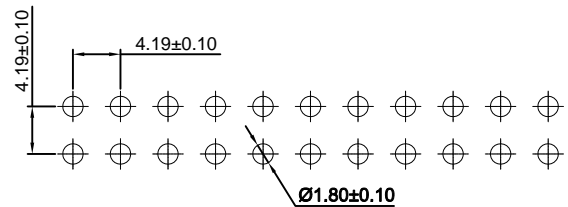
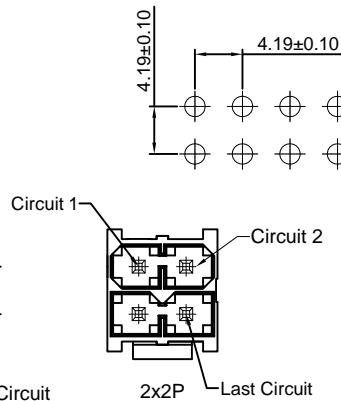
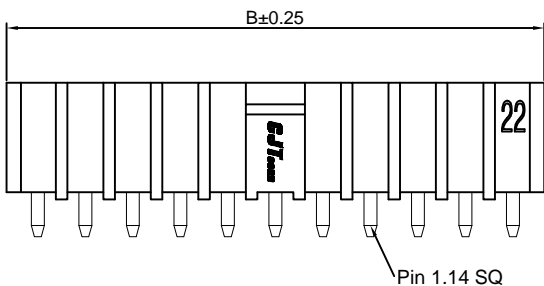
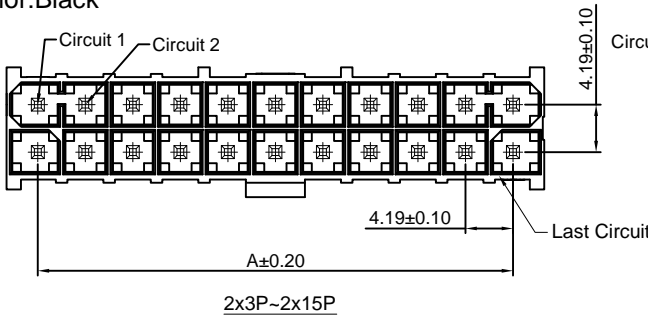

P.C.B LAYOUT

Ordering Information & Dimensions:

PART NO.	Dimensions	
	A	B
C4201WVS-2x2P	4.19	9.40
C4201WVS-2x3P	8.38	13.59
C4201WVS-2x4P	12.57	17.78
C4201WVS-2x5P	16.76	21.97
C4201WVS-2x6P	21.95	26.16
C4201WVS-2x7P	25.14	30.35
C4201WVS-2x8P	29.33	34.54
C4201WVS-2x9P	33.52	38.73
C4201WVS-2x10P	37.71	42.92
C4201WVS-2x11P	41.90	47.11
C4201WVS-2x12P	46.09	51.30
C4201WVS-2x13P	50.28	55.49
C4201WVS-2x14P	54.47	59.68
C4201WVS-2x15P	58.66	63.87

Unit: mm



C4201 SERIES

4.19mm pitch wire to board connector

C4201WVSB-2

4.19mm pitch 180° Dual Row Wafer

Reference Informations:

- *Material:Pin:Brass/Tin over Nickel
Insulator:LCP , UL94V-0
- *Suitable CJT C4201FS-T series Terminal
- *Mates with CJT C4201HFSB series dual row housing
- *Color:Black

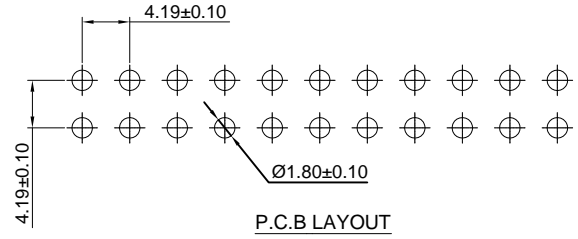
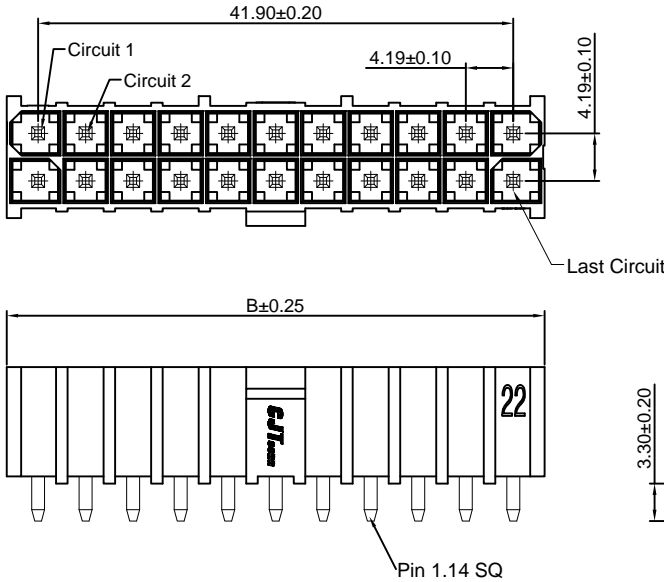

Ordering Information & Dimensions:

PART NO.	Dimensions	
	A	B
C4201WVSB-2x2P	4.19	9.40
C4201WVSB-2x3P	8.38	13.59
C4201WVSB-2x4P	12.57	17.78
C4201WVSB-2x5P	16.76	21.97
C4201WVSB-2x6P	21.95	26.16
C4201WVSB-2x7P	25.14	30.35
C4201WVSB-2x8P	29.33	34.54
C4201WVSB-2x9P	33.52	38.73
C4201WVSB-2x10P	37.71	42.92
C4201WVSB-2x11P	41.90	47.11
C4201WVSB-2x12P	46.09	51.30
C4201WVSB-2x13P	50.28	55.49
C4201WVSB-2x14P	54.47	59.68
C4201WVSB-2x15P	58.66	63.87

Unit: mm

C4201WVS-S-2

4.19mm Pitch 180° Dual Row Wafer-SMT TYPE

Reference Informations:

- *Material:Pin:Brass/Tin over Nickel
Insulator:LCP , UL94V-0
- *Suitable CJT C4201FS-T series Terminal
- *Mates with CJT C4201HFS series dual row housing
- *Color:Black

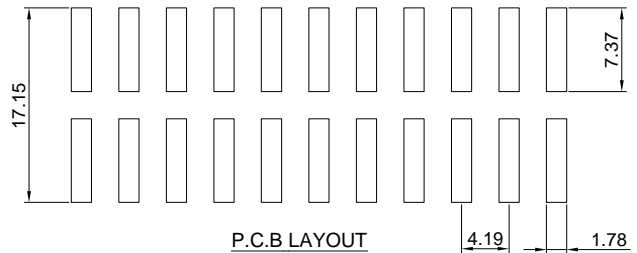
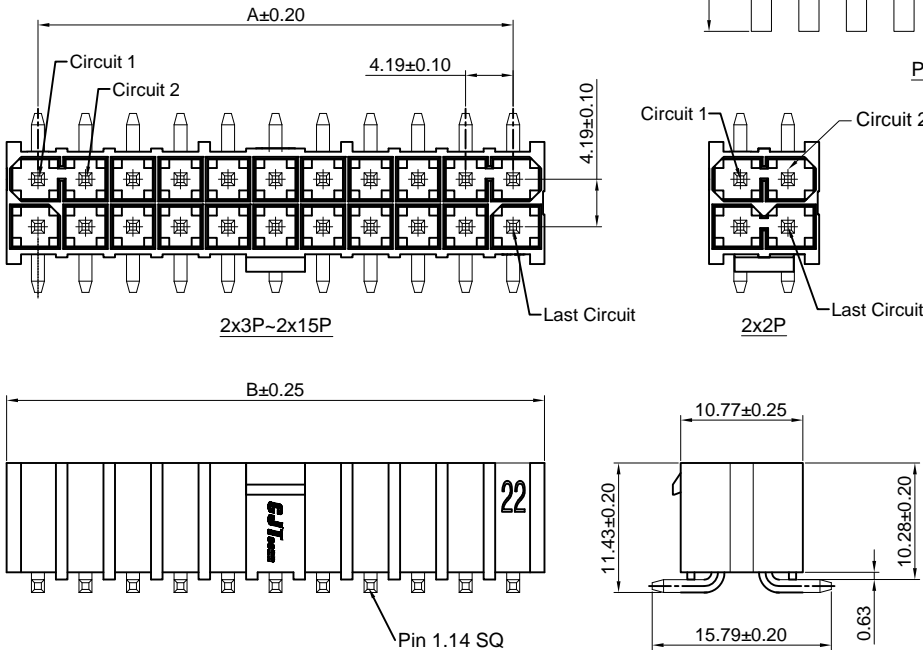

Ordering Information & Dimensions:

PART NO.	Dimensions	
	A	B
C4201WVS-S-2x2P	4.19	9.40
C4201WVS-S-2x3P	8.38	13.59
C4201WVS-S-2x4P	12.57	17.78
C4201WVS-S-2x5P	16.76	21.97
C4201WVS-S-2x6P	21.95	26.16
C4201WVS-S-2x7P	25.14	30.35
C4201WVS-S-2x8P	29.33	34.54
C4201WVS-S-2x9P	33.52	38.73
C4201WVS-S-2x10P	37.71	42.92
C4201WVS-S-2x11P	41.90	47.11
C4201WVS-S-2x12P	46.09	51.30
C4201WVS-S-2x13P	50.28	55.49
C4201WVS-S-2x14P	54.47	59.68
C4201WVS-S-2x15P	58.66	63.87

Unit: mm



C4201 SERIES

4.19mm pitch wire to board connector

C4201WVSB-S-2

4.19mm Pitch 180° Dual Row Wafer-SMT TYPE

Reference Informations:

- *Material:Pin:Brass/Tin over Nickel
Insulator:LCP , UL94V-0
- *Suitable CJT C4201FS-T series Terminal
- *Mates with CJT C4201HFSB series dual row housing
- *Color:Black

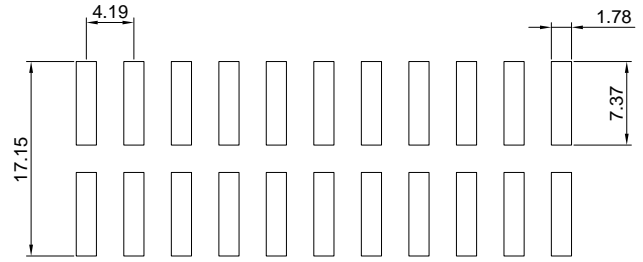
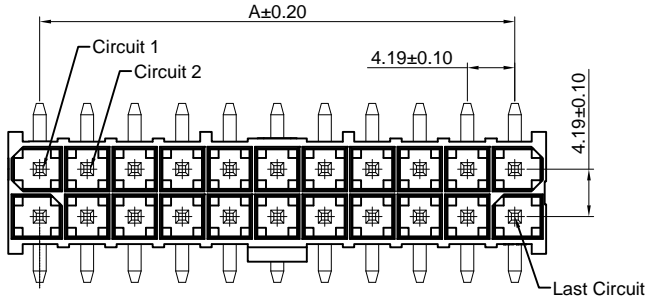

P.C.B LAYOUT

Ordering Information & Dimensions:

PART NO.	Dimensions	
	A	B
C4201WVSB-S-2x2P	4.19	9.40
C4201WVSB-S-2x3P	8.38	13.59
C4201WVSB-S-2x4P	12.57	17.78
C4201WVSB-S-2x5P	16.76	21.97
C4201WVSB-S-2x6P	21.95	26.16
C4201WVSB-S-2x7P	25.14	30.35
C4201WVSB-S-2x8P	29.33	34.54
C4201WVSB-S-2x9P	33.52	38.73
C4201WVSB-S-2x10P	37.71	42.92
C4201WVSB-S-2x11P	41.90	47.11
C4201WVSB-S-2x12P	46.09	51.30
C4201WVSB-S-2x13P	50.28	55.49
C4201WVSB-S-2x14P	54.47	59.68
C4201WVSB-S-2x15P	58.66	63.87

Unit: mm

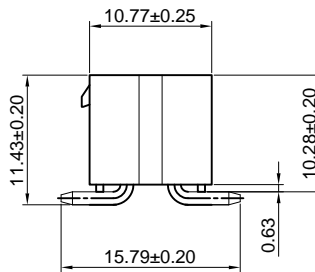
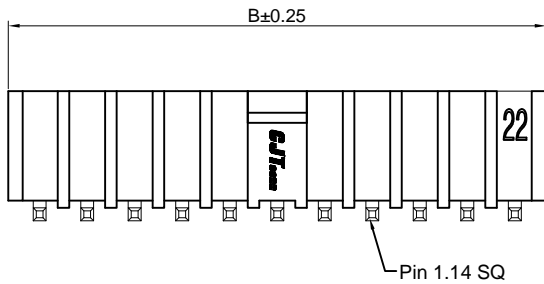

C4201WRS-2

4.19mm pitch 90° Dual Row Wafer

Reference Informations:

- *Material:Pin:Brass/Tin over Nickel
Insulator:LCP , UL94V-0
- *Suitable CJT C4201FS-T series Terminal
- *Mates with CJT C4201HFS series dual row housing
- *Color:Black

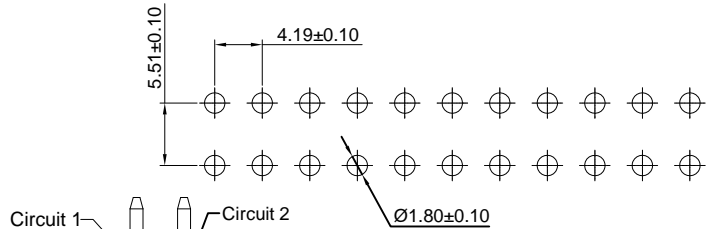
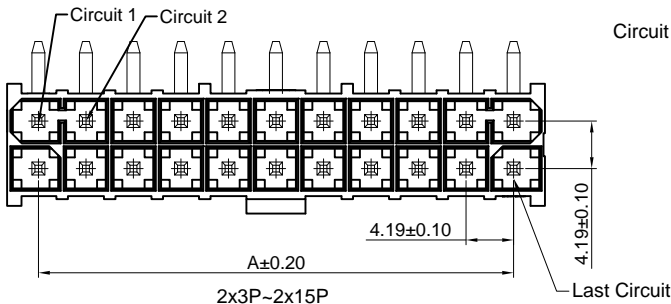

P.C.B LAYOUT

Ordering Information & Dimensions:

PART NO.	Dimensions	
	A	B
C4201WRS-2x2P	4.19	9.40
C4201WRS-2x3P	8.38	13.59
C4201WRS-2x4P	12.57	17.78
C4201WRS-2x5P	16.76	21.97
C4201WRS-2x6P	21.95	26.16
C4201WRS-2x7P	25.14	30.35
C4201WRS-2x8P	29.33	34.54
C4201WRS-2x9P	33.52	38.73
C4201WRS-2x10P	37.71	42.92
C4201WRS-2x11P	41.90	47.11
C4201WRS-2x12P	46.09	51.30
C4201WRS-2x13P	50.28	55.49
C4201WRS-2x14P	54.47	59.68
C4201WRS-2x15P	58.66	63.87

Unit: mm

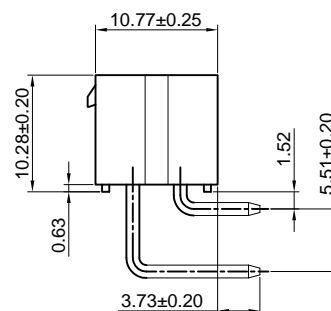
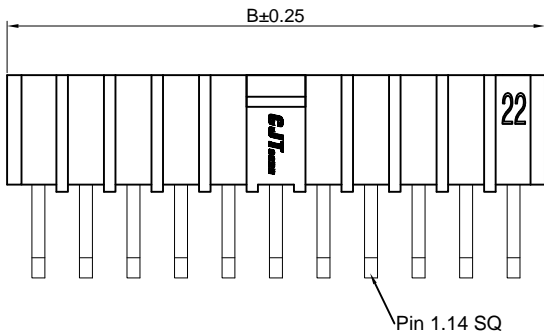



C4201 SERIES

4.19mm pitch wire to board connector

C4201WRSB-2

4.19mm Pitch 90° Dual Row Wafer

Reference Informations:

- *Material: Pin: Brass/Tin over Nickel
Insulator: LCP, UL94V-0
- *Suitable CJT C4201FS-T series Terminal
- *Mates with CJT C4201HFSB series dual row housing
- *Color: Black

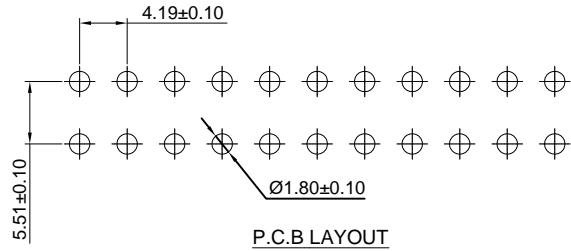
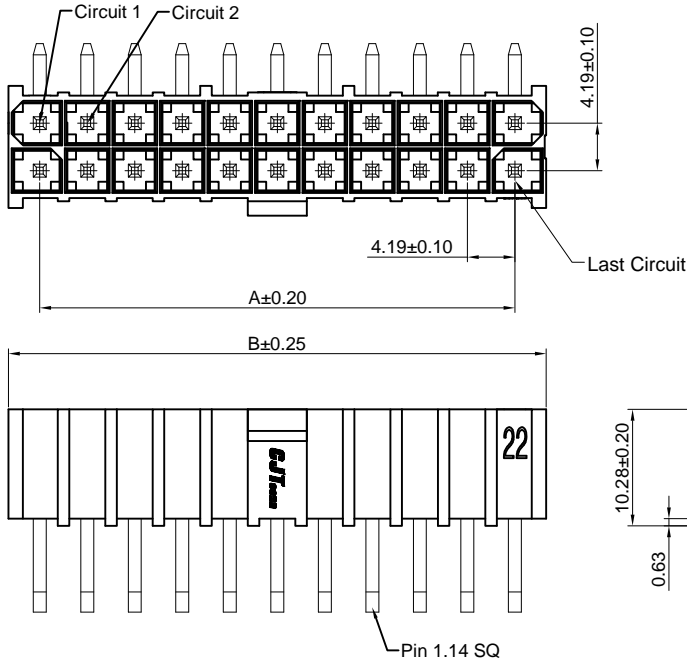

Ordering Information & Dimensions:

PART NO.	Dimensions	
	A	B
C4201WRSB-2x2P	4.19	9.40
C4201WRSB-2x3P	8.38	13.59
C4201WRSB-2x4P	12.57	17.78
C4201WRSB-2x5P	16.76	21.97
C4201WRSB-2x6P	21.95	26.16
C4201WRSB-2x7P	25.14	30.35
C4201WRSB-2x8P	29.33	34.54
C4201WRSB-2x9P	33.52	38.73
C4201WRSB-2x10P	37.71	42.92
C4201WRSB-2x11P	41.90	47.11
C4201WRSB-2x12P	46.09	51.30
C4201WRSB-2x13P	50.28	55.49
C4201WRSB-2x14P	54.47	59.68
C4201WRSB-2x15P	58.66	63.87

Unit: mm