

Product Summary

Symbol	Value	Unit
$I_{T(RMS)}$	0.8	A
$V_{DRM} V_{RRM}$	600	V
V_{TM}	1.55	V

Feature

With high ability to withstand the shock loading of large current, With high commutation performances, 4 quadrants products especially recommended for use on inductive load.

Application

Washing machine, vacuums, massager, solid state relay, AC Motor speed regulation and so on.

Package

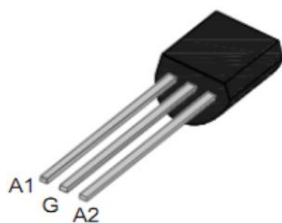

TO-92

Circuit diagram

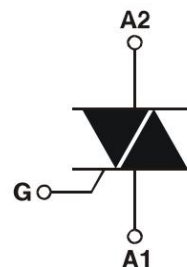

Marking

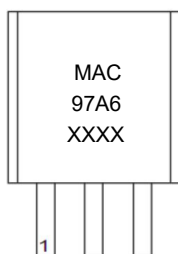

Absolute maximum ratings (Ta=25°C unless otherwise noted)

Parameter	Symbol	Value	Unit	
Repetitive peak off-state voltage	V_{DRM}	600	V	
Repetitive peak reverse voltage	V_{RRM}	600	V	
RMS on-state current	$I_{T(RMS)}$	0.8	A	
Non repetitive surge peak on-state current (full cycle, F=50Hz)	I_{TSM}	8	A	
I^2t value for fusing (tp=10ms)	I^2t	0.32	A ² s	
Critical rate of rise of on-state current ($I_G = 2 \times I_{GT}$)	di/dt	I - II - III	50	A/ μ s
		IV	10	
Peak gate current	I_{GM}	1	A	
Average gate power dissipation	$P_{G(AV)}$	0.5	W	
Junction Temperature	T_J	-40 ~ +125	°C	
Storage Temperature	T_{STG}	-40 ~ +150	°C	

Electrical characteristics (TA=25°C, unless otherwise noted)

Parameter	Symbol	Test Condition	Value	Unit		
Gate trigger current	I_{GT}	$V_D = 12V$ $I_T = 0.1A$ $T_J = 25^\circ C$	I - II - III	MAX.	5	mA
			IV		7	
Gate trigger voltage	V_{GT}	I - II - III - IV	MAX.	1.2	V	
Gate non-trigger voltage	V_{GD}	$V_D = V_{DRM}$ $T_J = 125^\circ C$	MIN.	0.2	V	
latching current	I_L	$V_D = 12V$ $I_{GT} = 0.1A$ $T_J = 25^\circ C$	I - III - IV	MAX.	10	mA
			II		15	
Holding current	I_H	I - II - III - IV	MAX.	10	mA	
Critical-rate of rise of commutation voltage	dV/dt	$V_D = 2/3V_{DRM}$ Gate Open $T_J = 125^\circ C$	MIN.	30	V/ μ s	
STATIC CHARACTERISTICS						
Forward "on" voltage	V_{TM}	$I_{TM} = 1.2A$ tp=380 μ s	MAX.	1.55	V	
Repetitive Peak Off-State Current	I_{DRM}	$V_D = V_{DRM}$ $V_R = V_{RRM}$	MAX.	5	μ A	
Repetitive Peak Reverse Current	I_{RRM}					$T_J = 125^\circ C$
THERMAL RESISTANCES						
Thermal resistance	Rth(j-c)	Junction to case(AC)	TYP.	60	°C/W	
	Rth(j-a)	Junction to ambient	TYP.	150	°C/W	

Typical Characteristics

FIG.1: Maximum power dissipation versus RMS on-state current (full cycle)

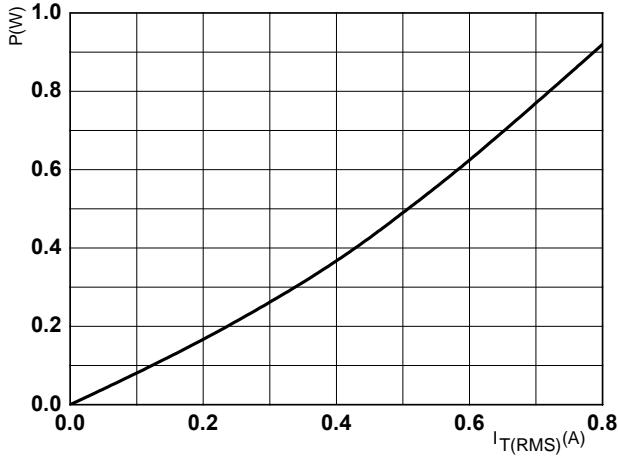

FIG.2: RMS on-state current versus case temperature (full cycle)

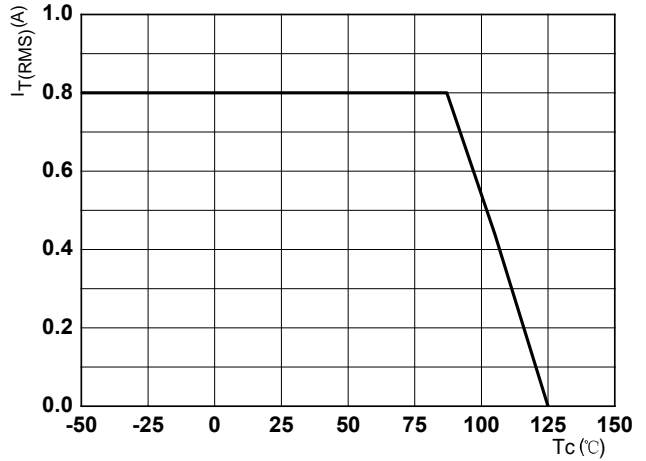

FIG.3: Surge peak on-state current versus number of cycles

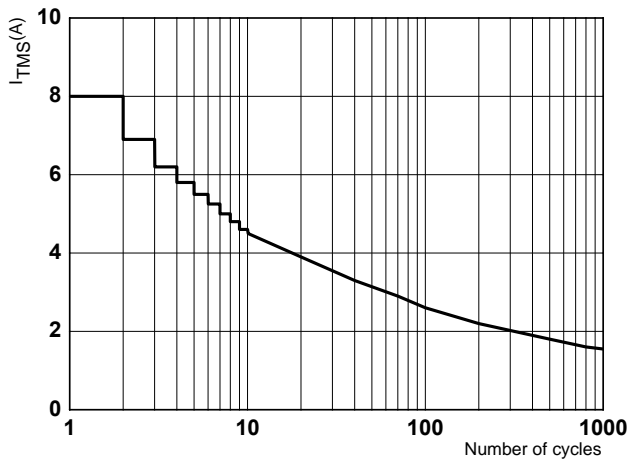

FIG.4: On-state characteristics (maximum values)

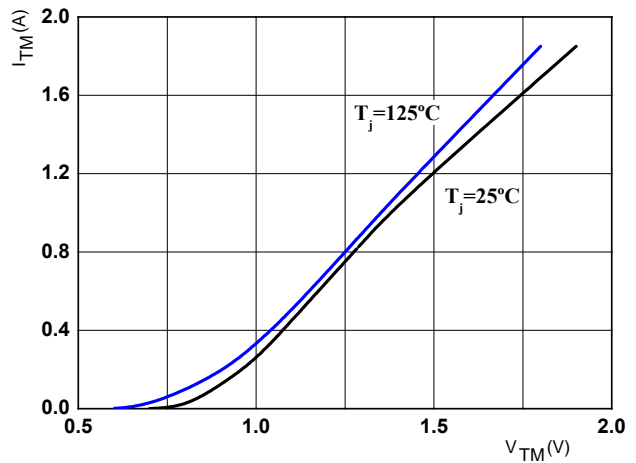

FIG.5: Non-repetitive surge peak on-state current for a sinusoidal pulse with width tp < 10ms

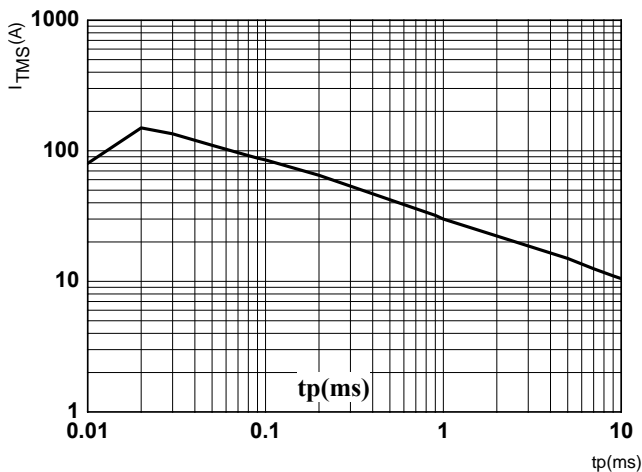
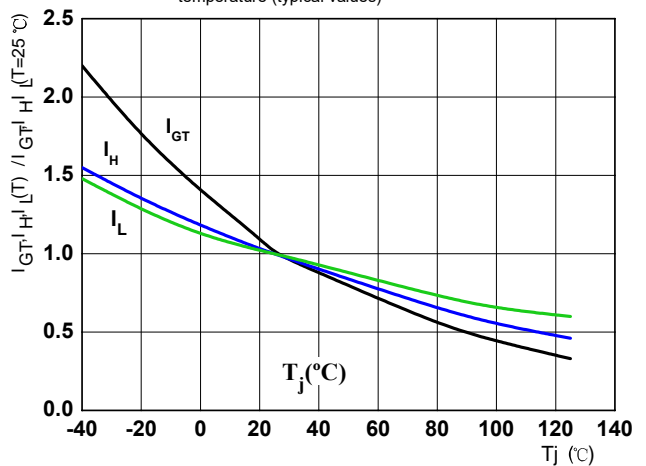
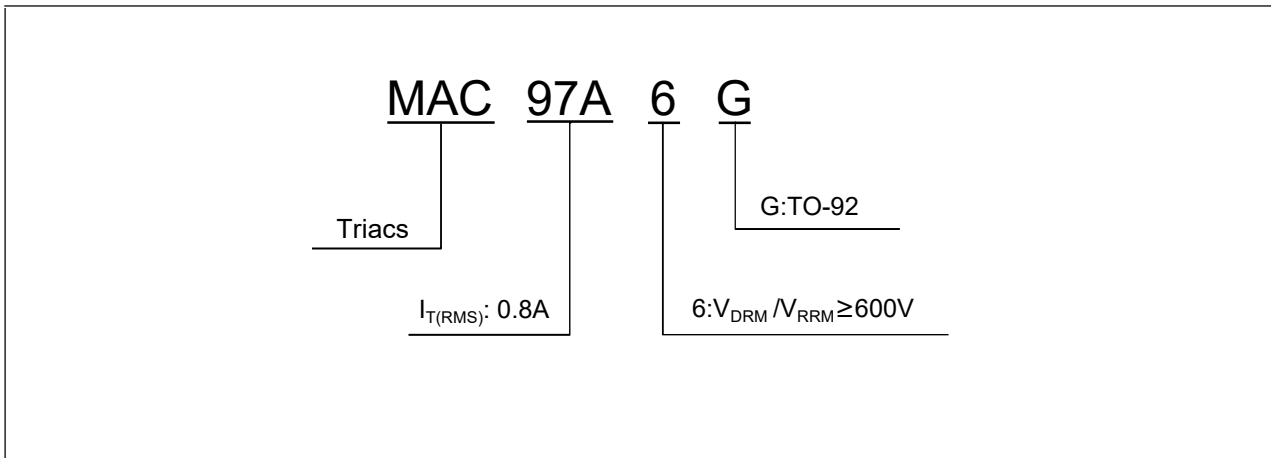

FIG.6: Relative variations of gate trigger current, holding current and latching current versus junction temperature (typical values)



Ordering Information



TO-92 Package Information

