

Features

- 200 Watts Peak Pulse Power per Line ($t_p=8/20\mu s$)
- Protects Up To Two Bidirectional I/O Lines
- Low Capacitance (0.4pF) For High-Speed Interfaces
- Working Voltages : 3.3V
- Ultra-small Package Requires Less Than 2.0x1.0mm of PCB area
- IEC61000-4-2 (ESD) $\pm 30kV$ (air), $\pm 30kV$ (contact)
- IEC61000-4-4 (EFT) 40A (5/50ns)
- IEC61000-4-5 (LIGHTNING) 13A (8/20 μs)

Applications

- 10/100/1000 Ethernet
- Integrated magnetics/RJ-45 connectors
- LAN/WAN Equipment
- Security Cameras
- Industrial Controls
- Peripherals
- Notebooks & Desktop Computers

Dimensions DFN2010T8

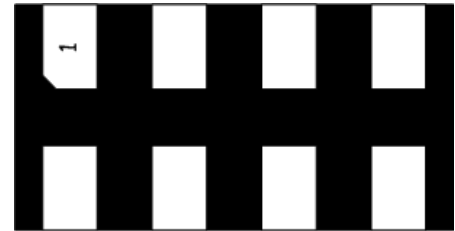

Pin Configuration

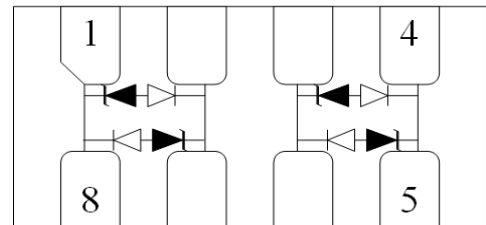

Mechanical Characteristics

- DFN 2.0x1.0mm Package
- Molding Compound Flammability Rating : UL 94V-O
- Weight 1 Milligrams (Approximate)
- Quantity Per Reel : 3,000pcs
- Reel Size : 7 inch
- Lead Finish : Lead Free

Absolute Maximum Ratings (Tamb=25°C unless otherwise specified)

Parameter	Symbol	Value	Unit
Peak Pulse Power (8/20 μs)	Ppp	200	W
ESD per IEC 61000-4-2 (Air)	V _{ESD}	± 30	Kv
ESD per IEC 61000-4-2 (Contact)		± 30	
Operating Temperature Range	T _J	-55 to +125	°C
Storage Temperature Range	T _{STJ}	-55 to +150	°C

Electrical Characteristics (TA=25°C unless otherwise specified)

Part Number	Device Marking	V _{RWM} (V)	V _{BR} (V)	I _T (mA)	V _C @1A	V _C		I _R μA (Max)	C (Pf) (Typ.)
						(Max)	(@A)		
ULC332010T8	U33	3	3.5	1	7	17	13	0.1	0.6

◆ Note 1 -- I_R : <0.1uA, T_C = 25°C, I_R : <1.0uA, T_C = 125°C

◆ Note 2 -- 0.6pF (max.), V_R=2.5V, f=1MHz.

TYPIC CHARACTERISTICS

8x20 μ s Pulse Waveform

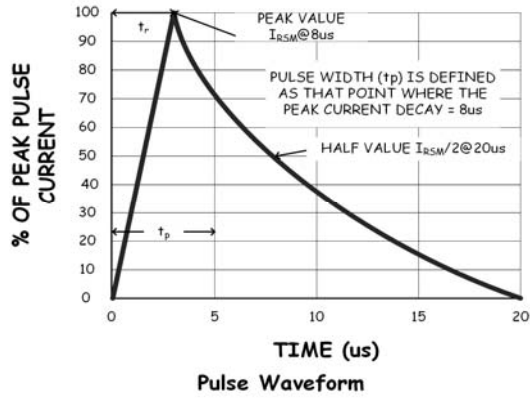

Power Derating Curve

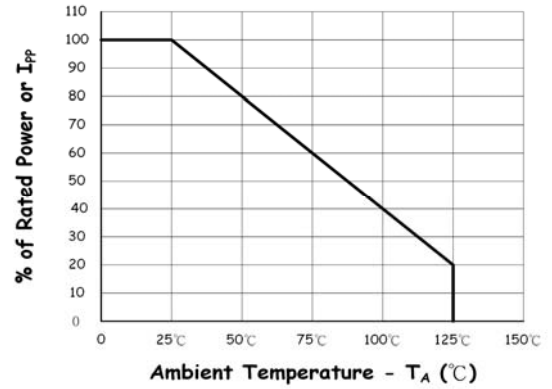

Clamping Voltage vs. Peak Pulse Current ($t_p=8/20\mu s$)

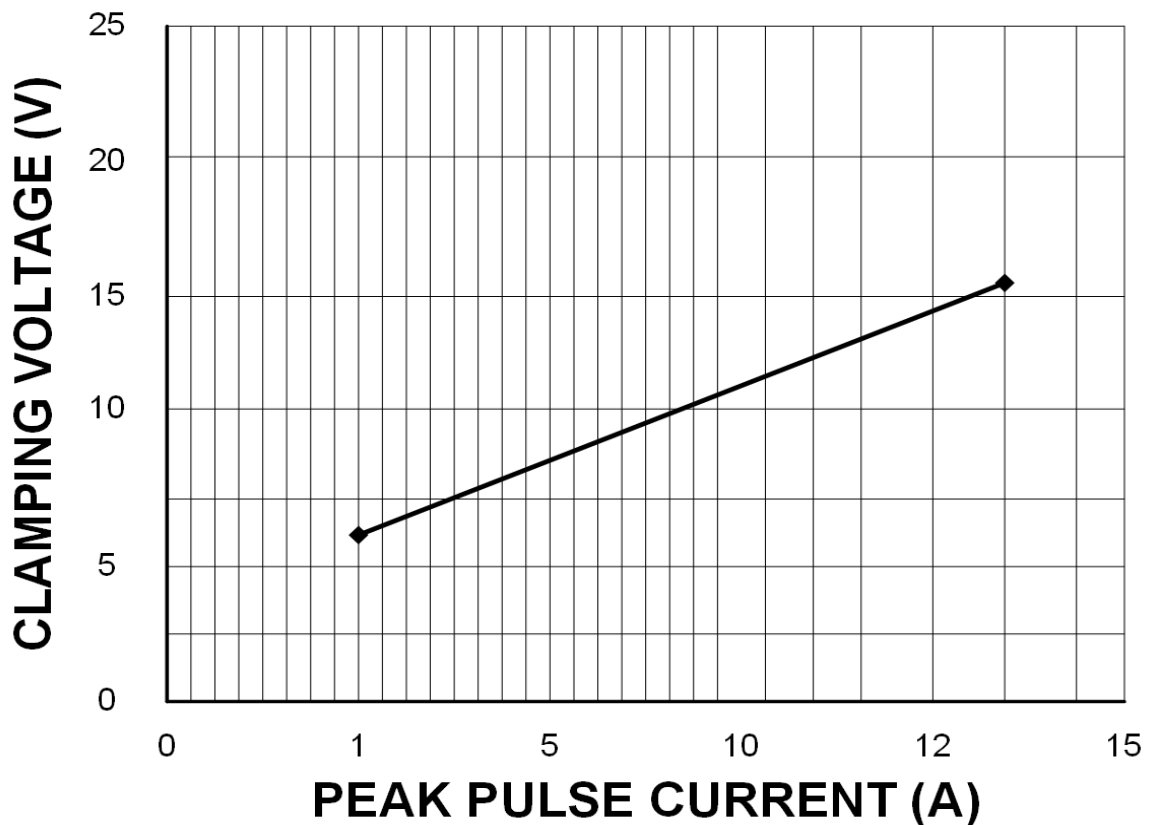

TYPIC CHARACTERISTICS

Typic Capacitance vs. Reverse Voltage

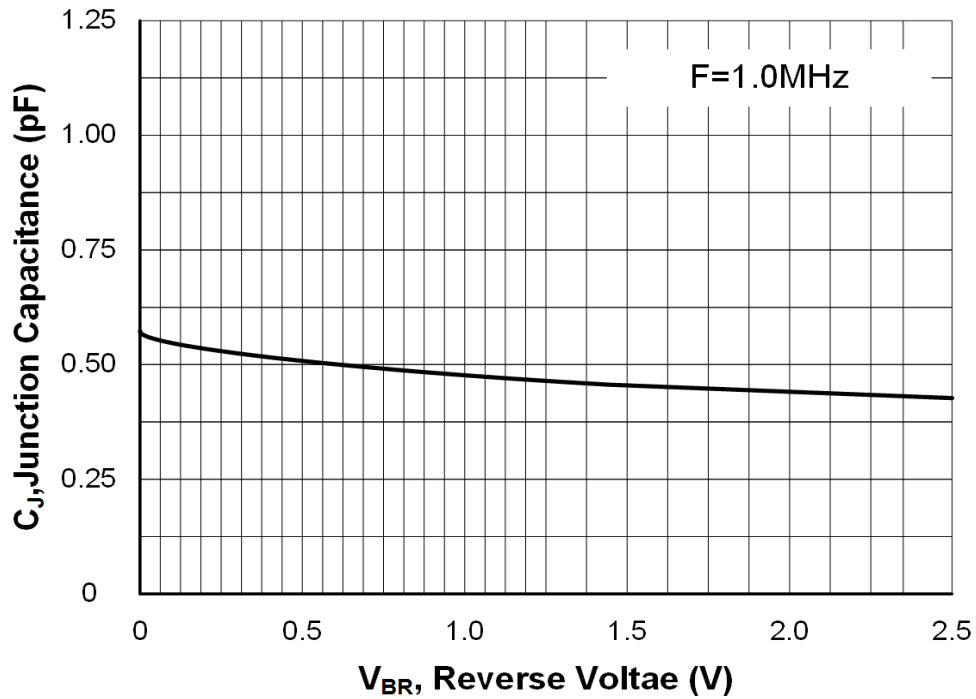

Typic Reverse Leakage vs. Temperature

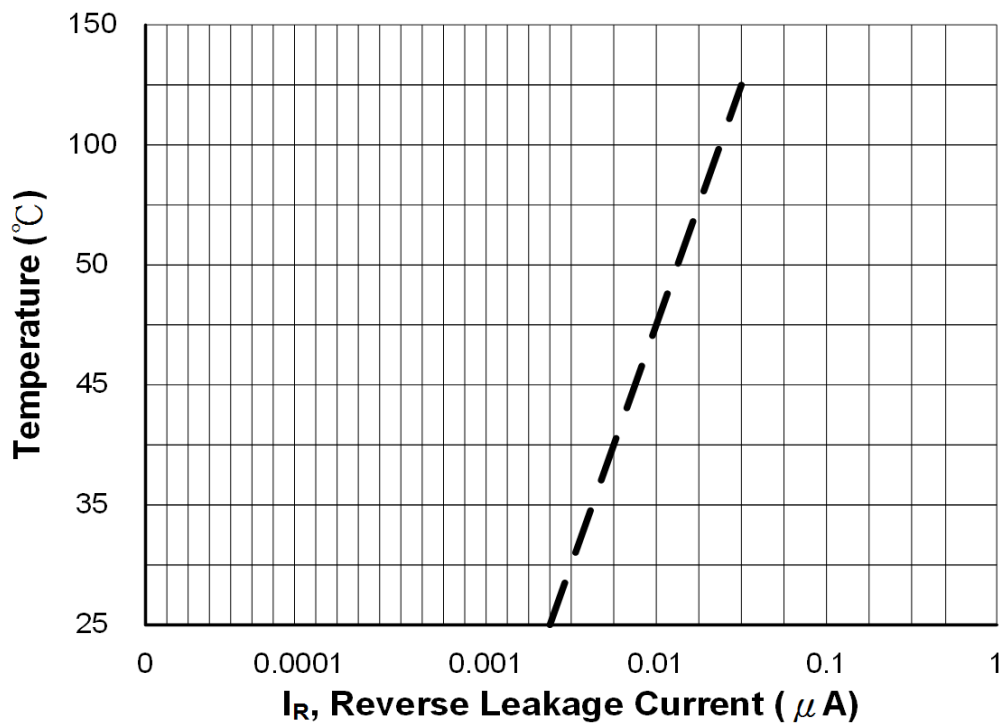

TYPIC CHARACTERISTICS

Typic Reverse Breakdown Voltage vs. Temperature

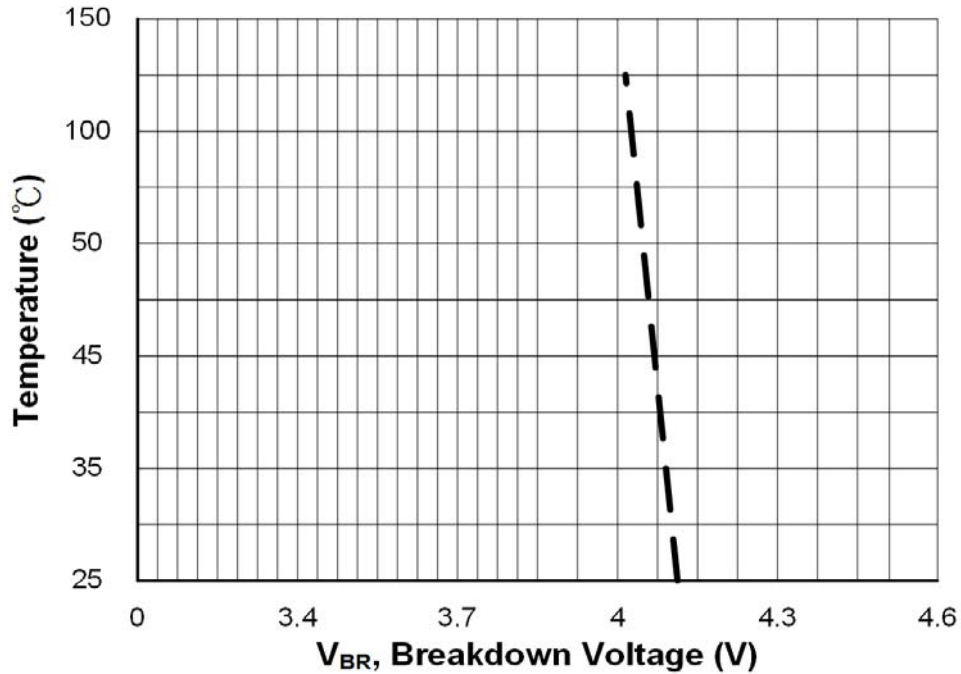

TLP Characterizations (Transmission Line Pulse)

TLP Characteristic

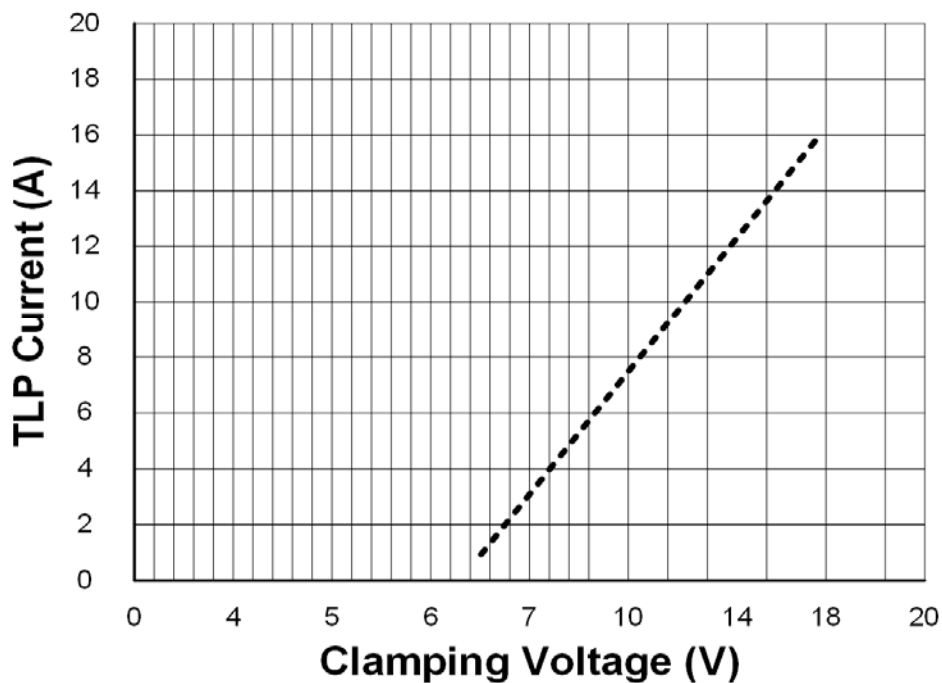

APPLICATION NOTES

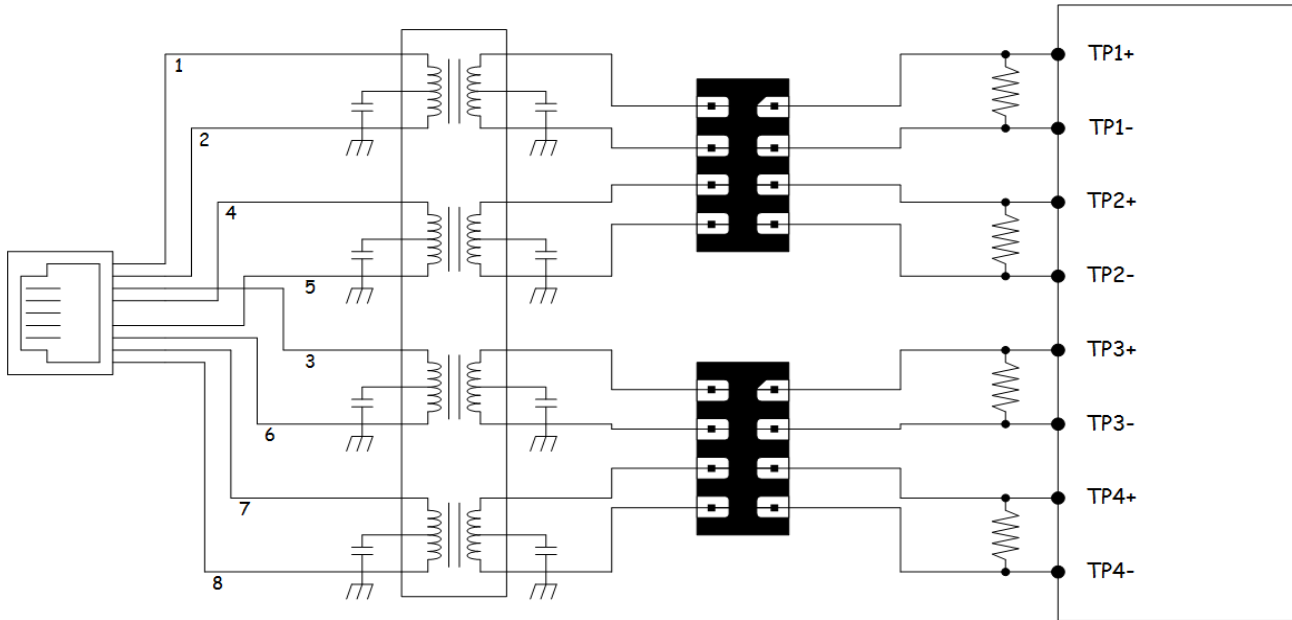

I/O to I/O Schematic Diagram for Gigabit Ethernet Protection

DFN2010T8 PACKAGE OUTLINE & DIMENSIONS

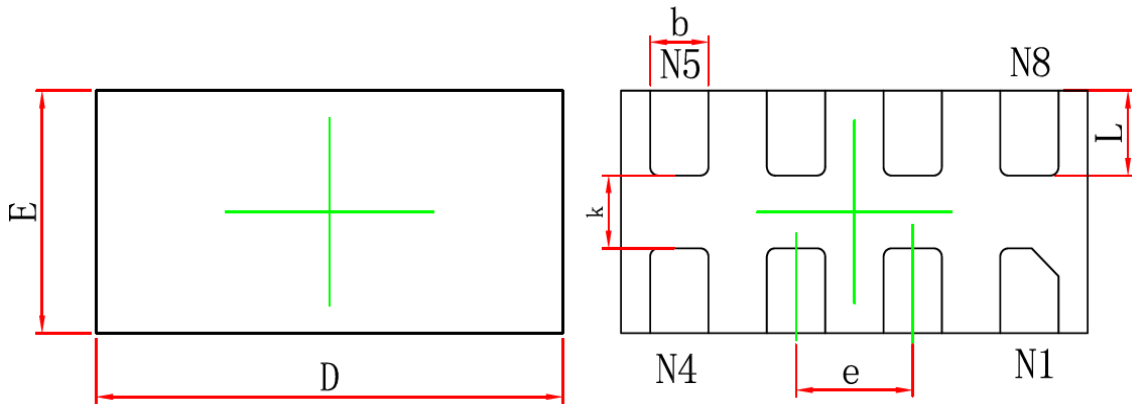

TOP VIEW

BOTTOM VIEW

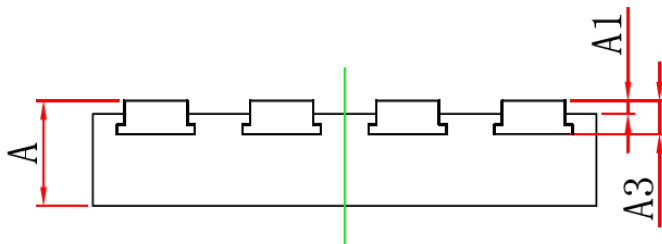

SIDE VIEW

Symbol	Dimensions In Millimeters		Dimensions In Inches	
	Min.	Max.	Min.	Max.
A	0.320	0.400	0.013	0.016
A1	-0.004	0.046	0.000	0.002
A3	0.110REF.		0.004REF.	
D	1.900	2.100	0.075	0.083
E	0.900	1.100	0.035	0.043
k	0.300REF		0.012REF	
b	0.200	0.300	0.008	0.012
e	0.500TYP.		0.020TYP.	
L	0.274	0.426	0.011	0.017