



Thyristor Module

V_{RRM} / V_{DRM} 800 to 1800V
I_{TAV} 25A

Applications

- Power Converters
- Lighting Control
- DC Motor Control and Drives
- Heat and temperature control

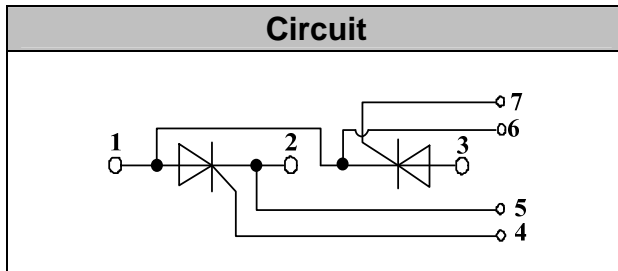

Features

- International standard package
- High Surge Capability
- Glass passivated chip
- Simple Mounting
- Heat transfer through aluminum oxide DBC ceramic isolated metal baseplate
- UL recognized applied for file no. E360040

Module Type

| TYPE | V _{RRM} | V _{RSM} |
|-----------|------------------|------------------|
| MT25C08T1 | 800V | 900V |
| MT25C12T1 | 1200V | 1300V |
| MT25C16T1 | 1600V | 1700V |
| MT25C18T1 | 1800V | 1900V |

Maximum Ratings

| Symbol | Conditions | Values | Units |
|------------------|--|--------------|------------------|
| I _{TAV} | Sine 180°;T _c =85°C | 25 | A |
| I _{TSM} | T _{VJ} =45°C t=10ms, sine T _{VJ} =125°C t=10ms, sine | 550 480 | A |
| i ² t | T _{VJ} =45°C t=10ms, sine T _{VJ} =125°C t=10ms, sine | 1500 1150 | A ² s |
| Visol | a.c.50HZ;r.m.s.;1min | 3000 | V |
| T _{vj} | | -40 to 125 | °C |
| T _{stg} | | -40 to 125 | °C |
| M _t | To terminals(M5) | 3± 15% | Nm |
| M _s | To heatsink(M6) | 5± 15% | Nm |
| di/dt | T _{VJ} = T _{VJM} , 2/3V _{DRM} ,I _G =500mA Tr<0.5us,tp>6us | 150 | A/us |
| dv/dt | T _J = T _{VJM} ,2/3V _{DRM} linear voltage rise | 1000 | V/us |
| a | Maximum allowable acceleration | 50 | m/s ² |
| Weight | Module(Approximately) | 100 | g |

Thermal Characteristics

| Symbol | Conditions | Values | Units |
|----------------------|----------------------------------|----------|-------|
| R _{th(j-c)} | Cont.;per thyristor / per module | 0.9/0.45 | °C/W |
| R _{th(c-s)} | per thyristor / per module | 0.2/0.1 | °C/W |



Electrical Characteristics

| Symbol | Conditions | Values | | | Units |
|-------------------|--|--------|------|------|------------|
| | | Min. | Typ. | Max. | |
| V_{TM} | $T=25^{\circ}C$ $I_{TM}=75A$ | | | 1.8 | V |
| I_{RRM}/I_{DRM} | $T_{VJ}=T_{VJM}$, $V_R=V_{RRM}$, $V_D=V_{DRM}$ | | | 10 | mA |
| V_{TO} | For power-loss calculations only ($T_{VJ}=125^{\circ}C$) | | | 0.9 | V |
| r_T | $T_{VJ}=T_{VJM}$ | | | 12 | m Ω |
| V_{GT} | $T_{VJ}=25^{\circ}C$, $V_D=6V$ | | | 2.5 | V |
| I_{GT} | $T_{VJ}=25^{\circ}C$, $V_D=6V$ | | | 150 | mA |
| V_{GD} | $T_{VJ}=125^{\circ}C$, $V_D=2/3V_{DRM}$ | | | 0.25 | V |
| I_{GD} | $T_{VJ}=125^{\circ}C$, $V_D=2/3V_{DRM}$ | | | 5 | mA |
| I_L | $T_{VJ}=25^{\circ}C$, $R_G=33\Omega$ | | 250 | 400 | mA |
| I_H | $T_{VJ}=25^{\circ}C$, $V_D=6V$ | | 100 | 200 | mA |
| tg d | $T_{VJ}=25^{\circ}C$, $I_G=1A$, $di_G/dt=1A/us$ | | 1 | | us |
| tq | $T_{VJ}=T_{VJM}$ | | 80 | | us |



Performance Curves

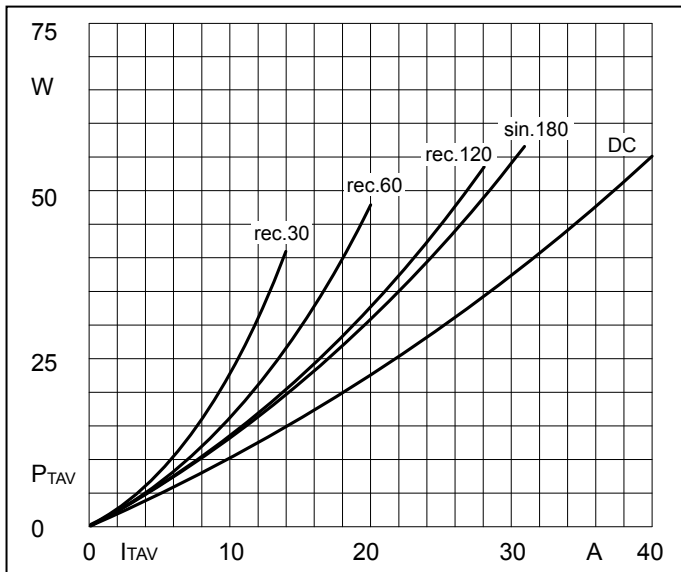

Fig1. Power dissipation

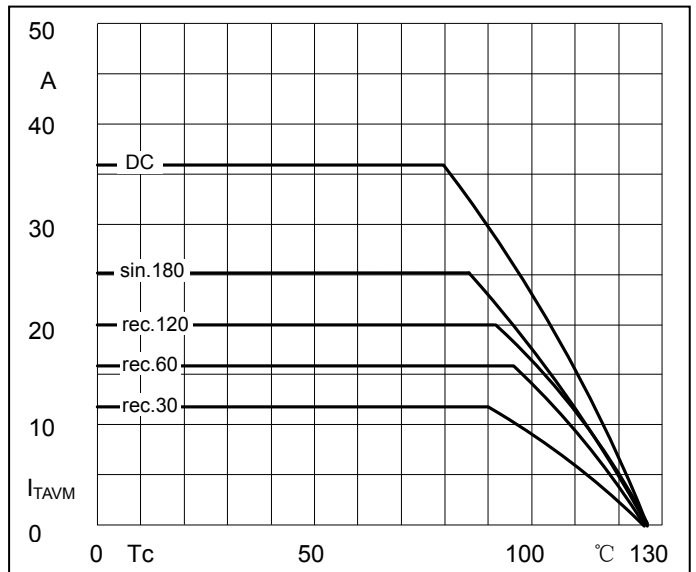

Fig2. Forward Current Derating Curve

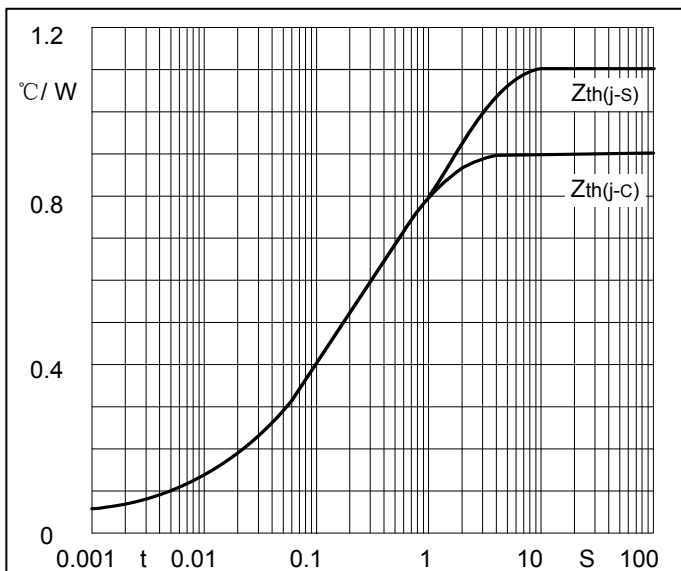

Fig3. Transient thermal impedance

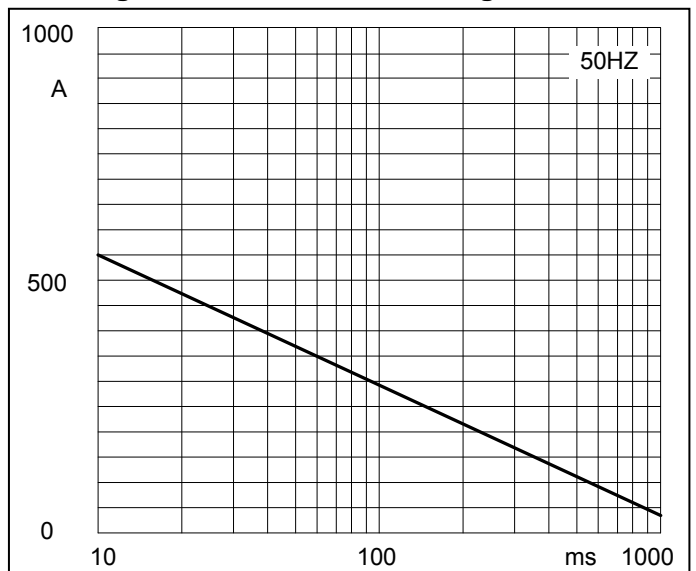

Fig4. Max Non-Repetitive Forward Surge Current

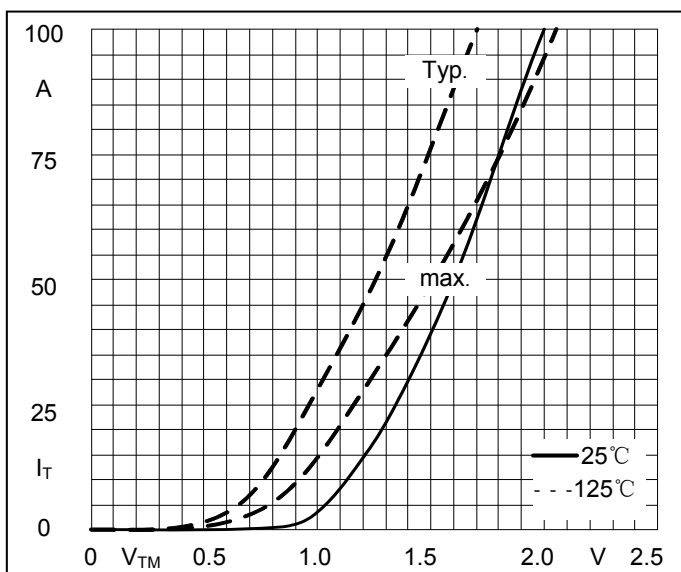

Fig5. Forward Characteristics

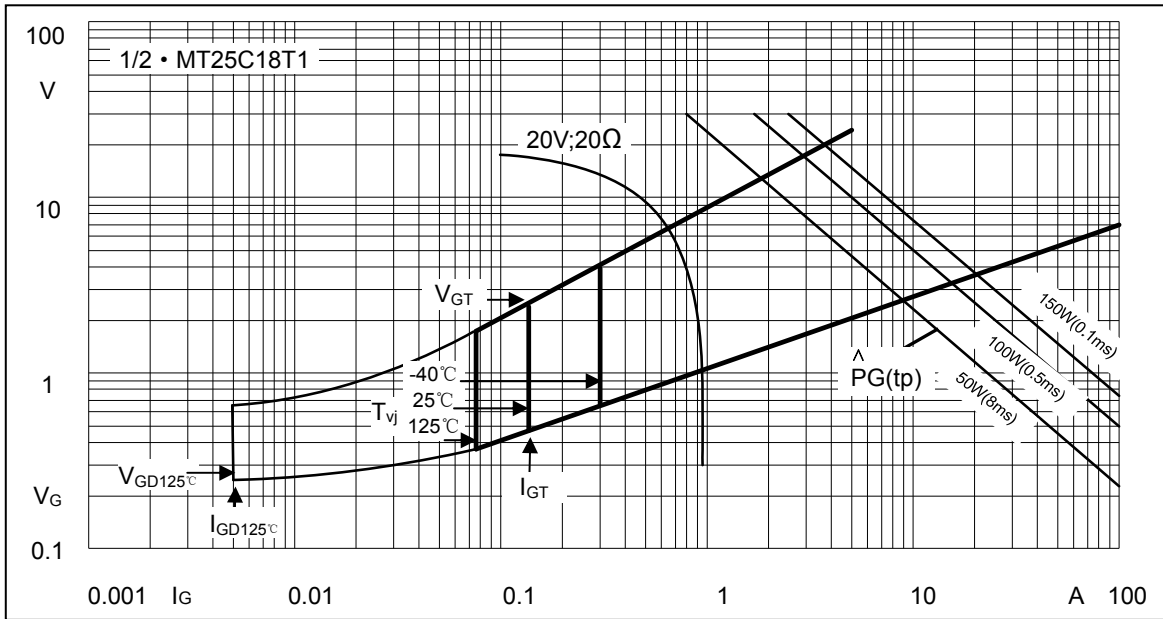
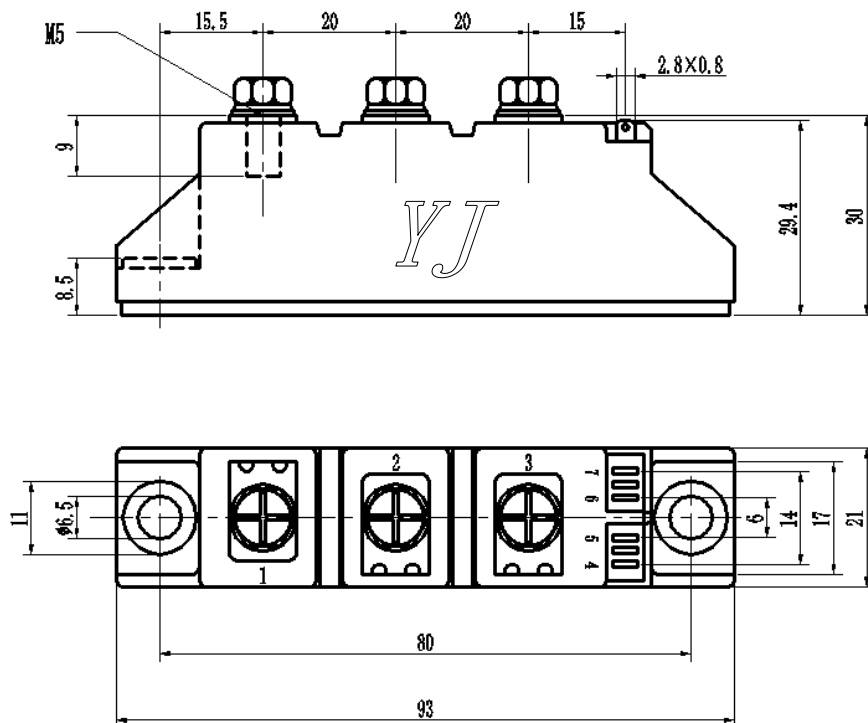

Fig6. Gate trigger Characteristics

Package Outline Information

CASE: T1



Dimensions in mm