



Glass Passivated Three Phase Rectifier Bridge

VRRM 800 to 1800V
ID 100 A

Applications

- Three phase rectifiers for power supplies
- Rectifiers for DC motor field supplies
- Battery charger rectifiers
- Input rectifiers for variable frequency drives

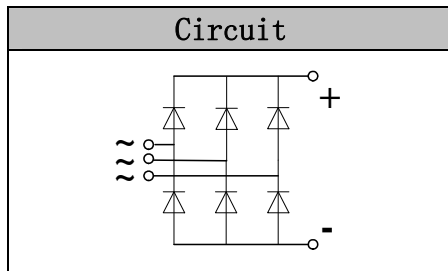

Features

- Three phase bridge rectifier
- Blocking voltage:800 to 1800V
- Heat transfer through aluminum oxide DBC ceramic isolated metal baseplate
- Glass passivated chip

Module Type

TYPE	VRRM	V _{RSM}
MD100S08NM2	800V	900V
MD100S12NM2	1200V	1300V
MD100S16NM2	1600V	1700V
MD100S18NM2	1800V	1900V

Maximum Ratings

Symbol	Conditions	Values	Units
I _D	Three phase, full wave T _c =100°C	100	A
I _{FSM}	t=10mS T _{vj} =45°C	750	A
i ² t	t=10mS T _{vj} =45°C	4200	A ² s
V _{isol}	a.c.50HZ;r.m.s.;1min	3000	V
T _{vj}		-40 to +150	°C
T _{stg}		-40 to +125	°C
M _t	To terminals(M5)	3±15%	Nm
M _s	To heatsink(M5)	3±15%	Nm
Weight	Module (Approximately)	130	g

Thermal Characteristics

Symbol	Conditions	Values	Units
R _{th(j-c)}	Per diode	1.0	°C/W
R _{th(c-s)}	Module (Approximately)	0.07	°C/W

Electrical Characteristics

Symbol	Conditions	Values			Units
		Min.	Typ.	Max.	
V _{FM}	T=25°C I _F =150A	—	1.70	1.90	V
I _{RD}	T _{vj} =25°C V _{RD} =V _{RRM} T _{vj} =150°C V _{RD} =V _{RRM}	—	—	0.3 5	mA mA



Performance Curves

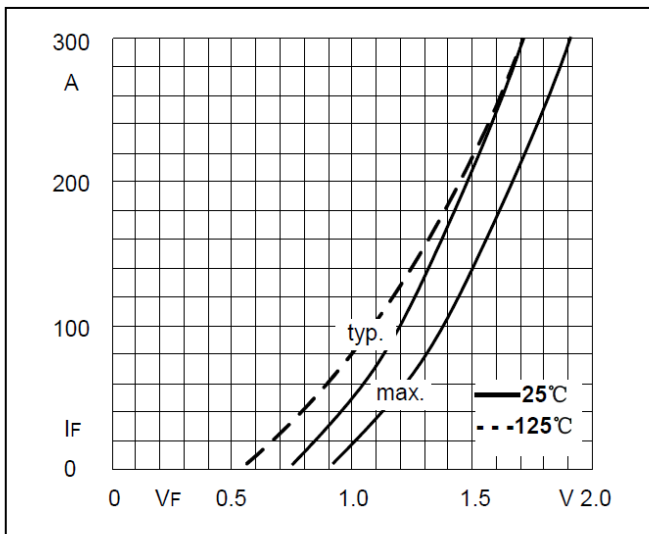

Fig1. Forward Characteristics

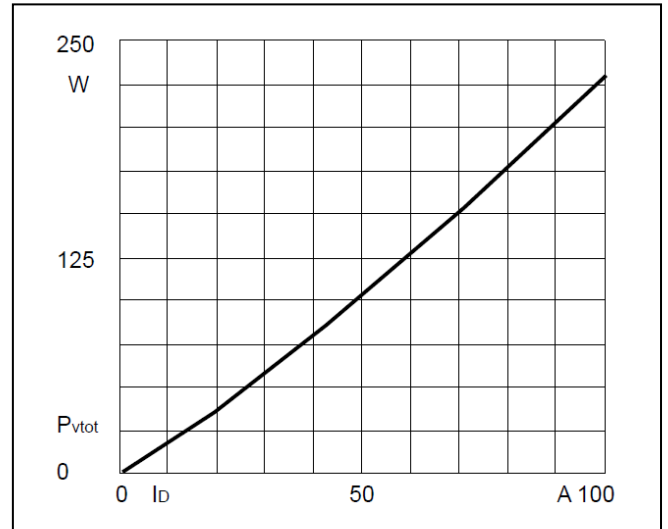

Fig2. Power dissipation

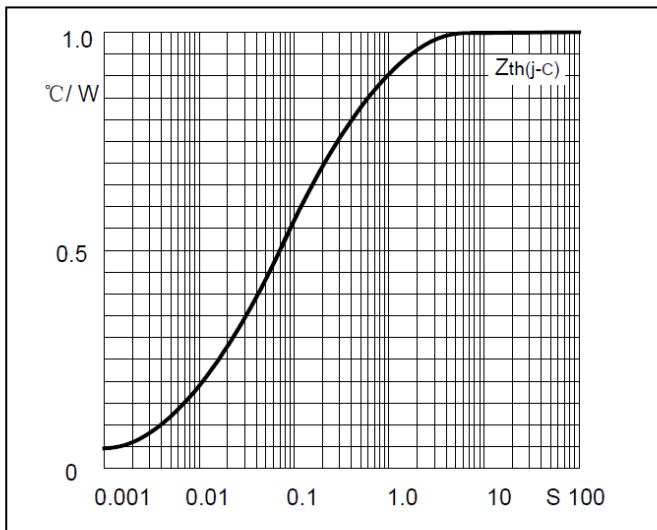

Fig3. Transient thermal impedance

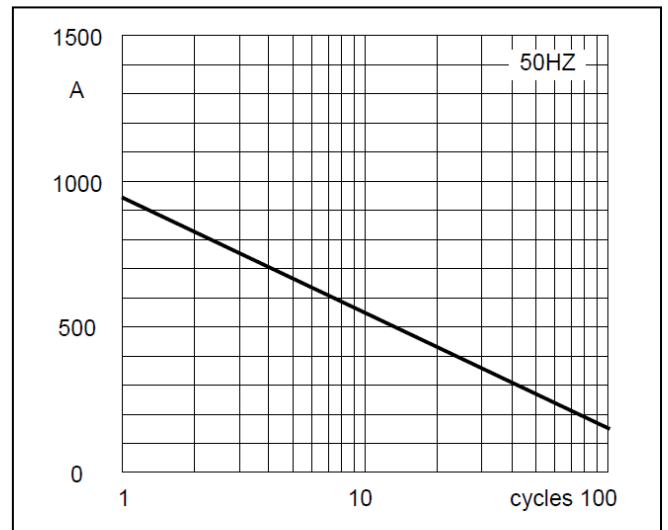

Fig4. Max Non-Repetitive Forward Surge Current

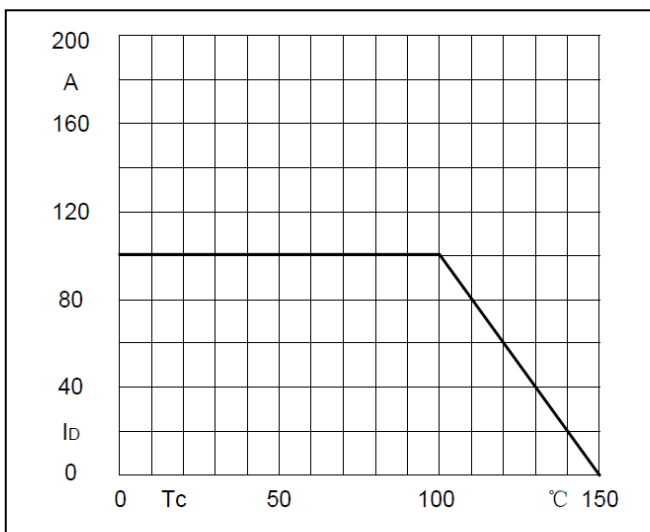
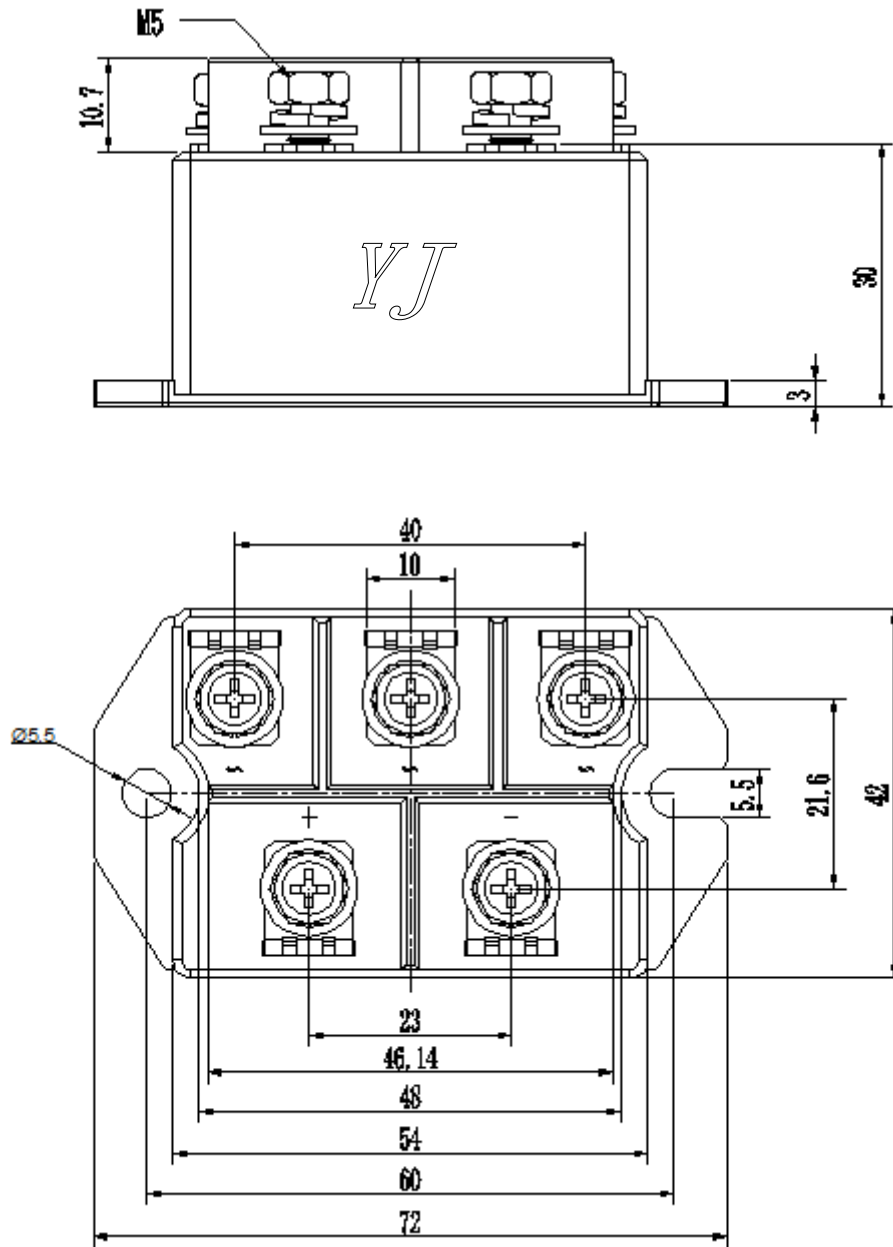

Fig5. Forward Current Derating Curve

Package Outline Information

CASE: M2



Dimensions in mm