



FRED Modules

V_{RRM} 600V
I_{FAV} 2×60A

Applications

- Inversion Welder
- Uninterruptible Power Supply (UPS)
- Plating Power Supply
- Ultrasonic Cleaner and Welder
- Power Factor Correction (PFC) Circuit
- Converter & Chopper

Features

- Soft Reverse Recovery Characteristics
- Ultrafast Reverse Recovery Time
- Low Reverse Recovery Loss
- Low Forward Voltage
- High Surge Current Capability
- Popular SOT-227 Package

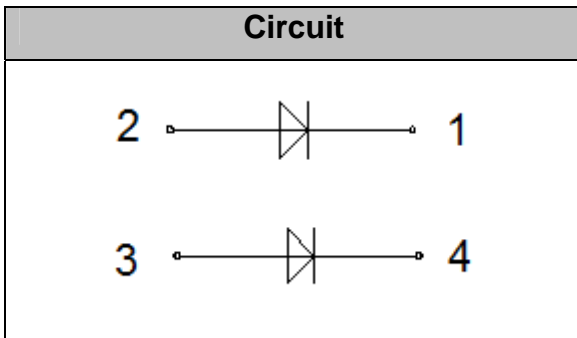

Maximum Ratings

| Symbol | Conditions | Values | Units |
|---------------------|---|-------------|------------------|
| V _R | | 600 | V |
| V _{RRM} | | 600 | V |
| I _{F(AV)} | T _C =90°C, Per diode | 60 | A |
| | T _C =90°C, Per Module | 120 | A |
| | T _C =90°C, 20KHz, Per Module | 80 | A |
| I _{F(RMS)} | T _C =90°C, Per diode | 85 | A |
| I _{FSM} | 1/2 Cycle, 50Hz, Sine | 550 | A |
| | 1/2 Cycle, 60Hz, Sine | 600 | A |
| I ² t | T _J =45°C, t=10ms, 50Hz, Sine | 1510 | A ² s |
| | T _J =45°C, t=8.3ms, 60Hz, Sine | 1490 | A ² s |
| P _D | T _C =25°C | 208 | W |
| T _J | | -40 to +150 | °C |
| T _{STG} | | -40 to +125 | °C |
| Visol | 3600V AC 1s | 1 | mA |
| Torque | To Sink Recommended (M4) | 0.7~1.5 | N·m |
| Torque | To Terminal Recommended (M4) | 0.7~1.1 | N·m |
| Weight | | 27 | g |

Thermal Characteristics

| Symbol | Conditions | Values | Units |
|----------------------|------------|--------|-------|
| R _{th(j-c)} | Per diode | 0.6 | °C/W |



Electrical Characteristics

| Symbol | Conditions | Values | | | Units |
|-----------|---|--------|------|------|-------|
| | | Min. | Typ. | Max. | |
| I_{RM} | $V_R=600V$ | -- | -- | 0.1 | mA |
| | $V_R=600V, T_J=125^\circ C$ | -- | -- | 1 | mA |
| V_F | $I_F=60A$ | -- | 1.2 | 1.4 | V |
| | $I_F=60A, T_J=125^\circ C$ | -- | 1.05 | 1.25 | V |
| t_{rr} | $I_F=1A, V_R=30V, di_F/dt=-200A/\mu s$ | -- | 50 | 60 | ns |
| t_{rr} | $V_R=300V, I_F=60A, di_F/dt=-200A/\mu s, T_J=25^\circ C$ | -- | 75 | -- | ns |
| I_{RRM} | | -- | 7.2 | -- | A |
| t_{rr} | $V_R=300V, I_F=60A, di_F/dt=-200A/\mu s, T_J=125^\circ C$ | -- | 135 | -- | ns |
| I_{RRM} | | -- | 16 | -- | A |

Performance Curves

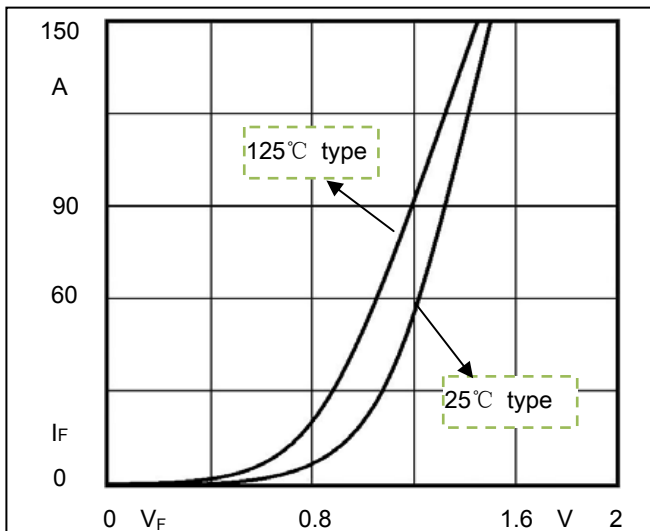

Fig1. Forward Voltage Drop vs Forward Current

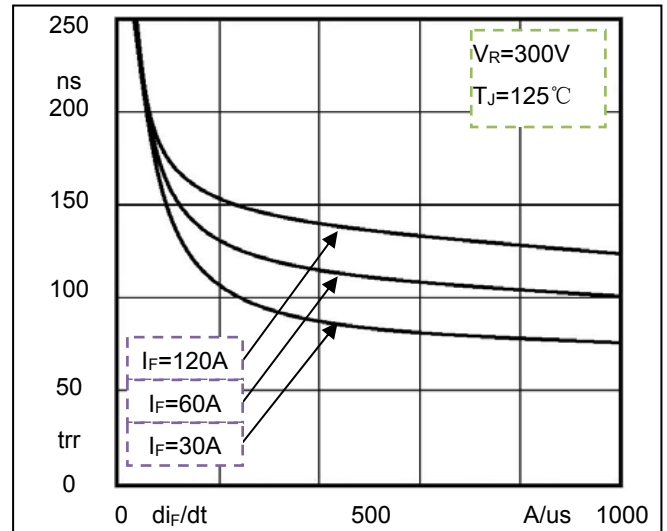

Fig2. Reverse Recovery Time vs di_F/dt

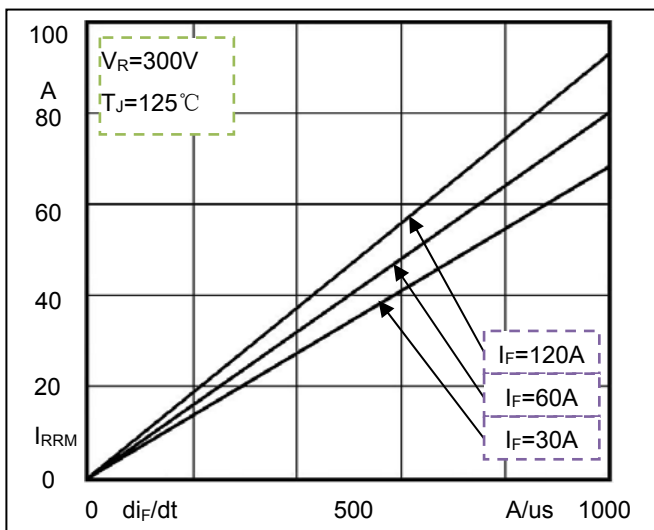

Fig3. Reverse Recovery Current vs di_F/dt

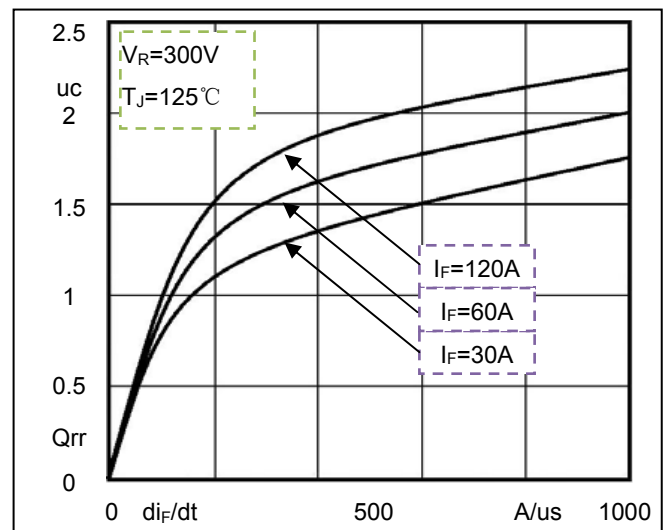

Fig4. Reverse Recovery Charge vs di_F/dt

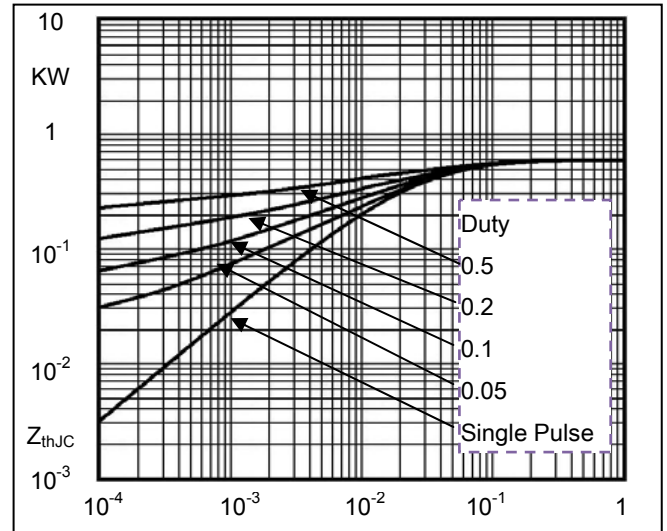
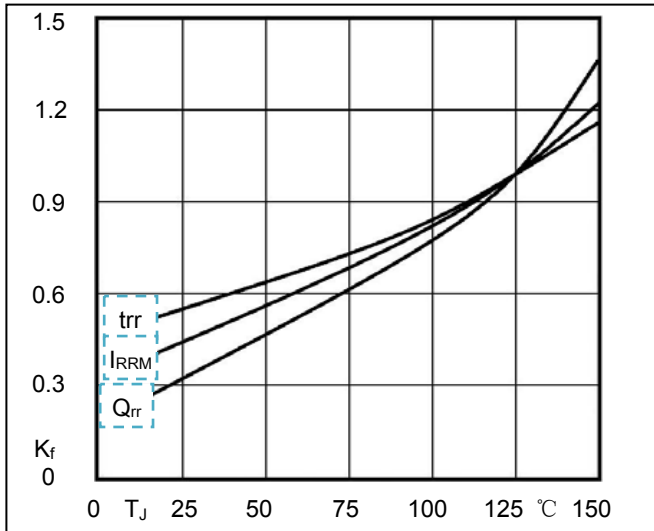

Fig5. Dynamic Parameters vs Junction Temperature

Fig6. Transient Thermal Impedance

Package Outline Information

