



Glass Passivated Three Phase Rectifier Bridge

VRRM 800 to 1800V
ID 100 A

Applications

- Three phase rectifiers for power supplies
- Rectifiers for DC motor field supplies
- Battery charger rectifiers
- Input rectifiers for variable frequency drives

Features

- Three phase bridge rectifier
- Blocking voltage:800 to 1800V
- Heat transfer through aluminum oxide DBC ceramic isolated metal baseplate
- Glass passivated chip

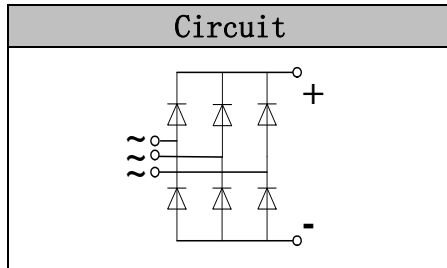

Module Type

TYPE	VRRM	VRSM
MD100S08M8	800V	900V
MD100S12M8	1200V	1300V
MD100S16M8	1600V	1700V
MD100S18M8	1800V	1900V

Maximum Ratings

Symbol	Conditions	Values	Units
ID	Three phase, full wave Tc=100°C	100	A
IFSM	t=10mS Tvj =45°C	920	A
i ² t	t=10mS Tvj =45°C	4200	A ² s
Visol	a.c.50HZ;r.m.s.;1min	3000	V
Tvj		-40 to +150	°C
Tstg		-40 to +125	°C
Mt	To terminals (M5)	3±15%	Nm
Ms	To heatsink (M6)	5±15%	Nm
Weight	Module (Approximately)	168	g

Thermal Characteristics

Symbol	Conditions	Values	Units
Rth(j-c)	Per diode	0.9	°C/W
Rth(c-s)	Module	0.03	°C/W

Electrical Characteristics

Symbol	Conditions	Values			Units
		Min.	Typ.	Max.	
VFM	T=25°C IF =300A	—	1.70	1.90	V
IRD	Tvj=25°C VRD=VRRM	—	—	0.3	mA
	Tvj=150°C VRD=VRRM	—	—	5	mA



Performance Curves

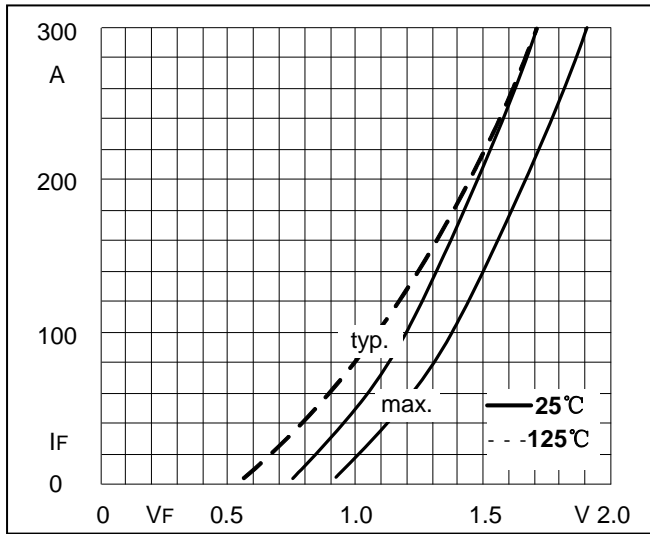

Fig1. Forward Characteristics

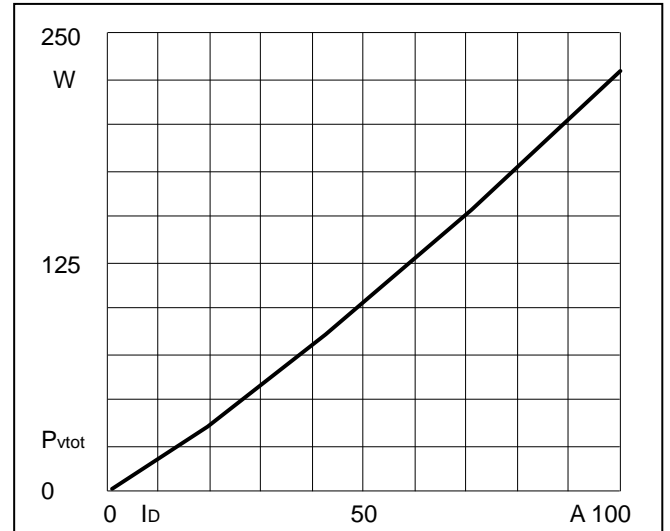

Fig2. Power dissipation

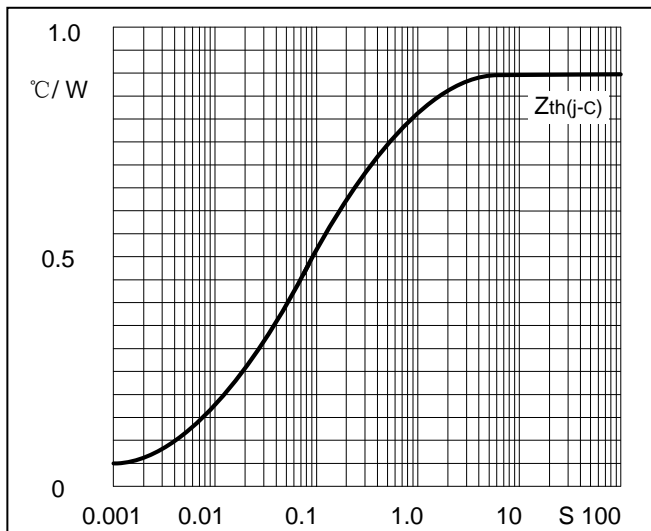

Fig3. Transient thermal impedance

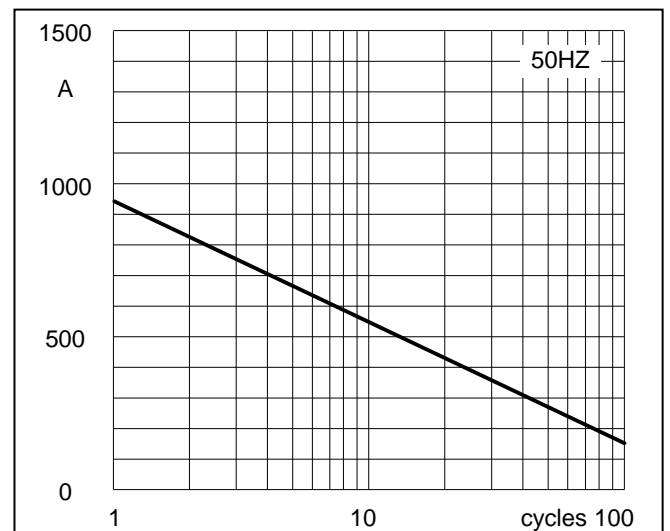

Fig4. Max Non-Repetitive Forward Surge Current

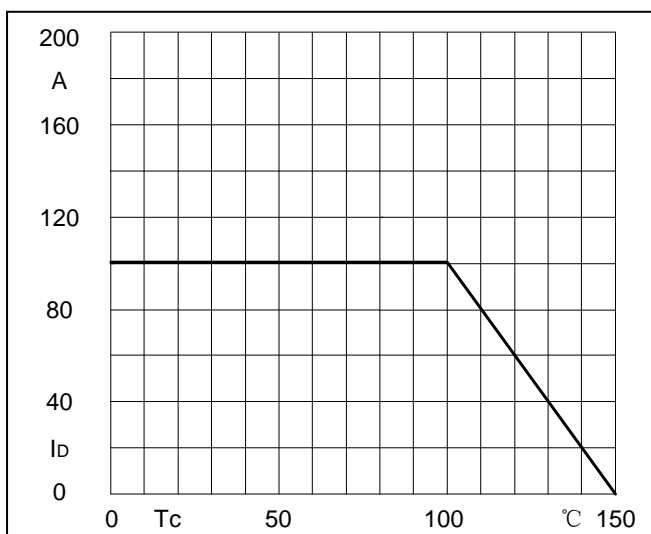
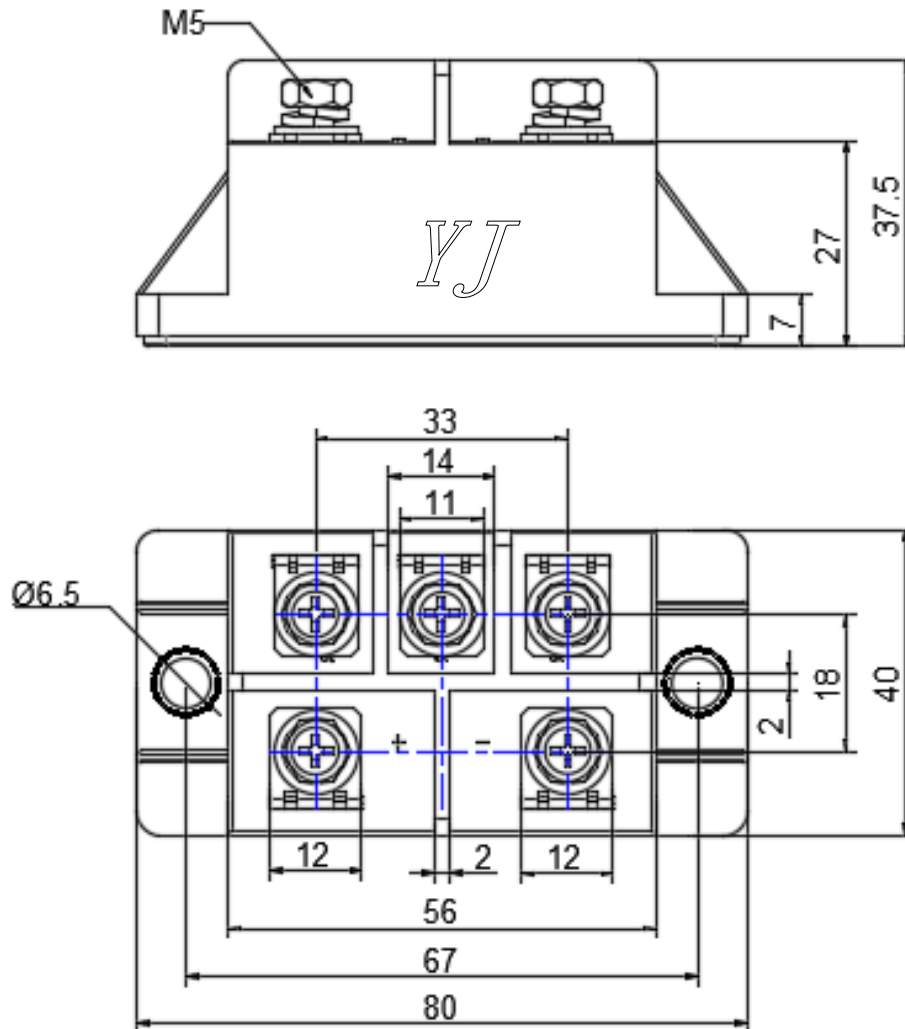

Fig5. Forward Current Derating Curve

Package Outline Information

CASE: M8



Dimensions in mm
Tolerance: 0.5mm