



## Glass Passivated Three Phase Rectifier Bridge

**VRRM** 800 to 1800V  
**ID** 75 A

### Applications

- Three phase rectifiers for power supplies
- Rectifiers for DC motor field supplies
- Battery charger rectifiers
- Input rectifiers for variable frequency drives

### Features

- Three phase bridge rectifier
- Blocking voltage:800 to 1800V
- Heat transfer through aluminum oxide DBC ceramic isolated metal baseplate
- Glass passivated chip
- UL recognized applied for file no. E360040

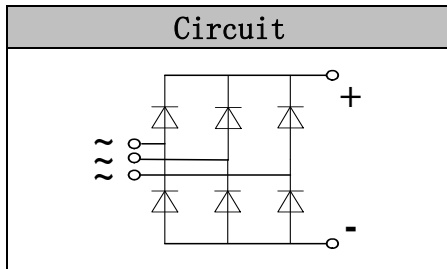

### Module Type

TYPE	VRRM	VRSM
MD75S08M2	800V	900V
MD75S12M2	1200V	1300V
MD75S16M2	1600V	1700V
MD75S18M2	1800V	1900V

### Maximum Ratings

Symbol	Conditions	Values	Units
$I_D$	Three phase, full wave $T_c=110^\circ\text{C}$	75	A
$I_{FSM}$	$t=10\text{ms}$ $T_{vj}=45^\circ\text{C}$	750	A
$i^2t$	$t=10\text{ms}$ $T_{vj}=45^\circ\text{C}$	2800	$\text{A}^2\text{s}$
$V_{isol}$	a.c.50HZ;r.m.s.;1min	3000	V
$T_{vj}$		-40 to +150	$^\circ\text{C}$
$T_{stg}$		-40 to +125	$^\circ\text{C}$
$M_t$	To terminals(M5)	$5\pm 15\%$	Nm
$M_s$	To heatsink(M5)	$5\pm 15\%$	Nm
Weight	Module (Approximately)	130	g

### Thermal Characteristics

Symbol	Conditions	Values	Units
$R_{th(j-c)}$	Per diode	1.1	$^\circ\text{C}/\text{W}$
$R_{th(c-s)}$	Module (Approximately)	0.07	$^\circ\text{C}/\text{W}$

### Electrical Characteristics

Symbol	Conditions	Values			Units
		Min.	Typ.	Max.	
$V_{FM}$	$T=25^\circ\text{C}$ $I_F=150\text{A}$	—	1.38	1.60	V
$I_{RD}$	$T_{vj}=25^\circ\text{C}$ $V_{RD}=V_{RRM}$	—	—	0.3	mA
	$T_{vj}=150^\circ\text{C}$ $V_{RD}=V_{RRM}$	—	—	5	mA



### Performance Curves

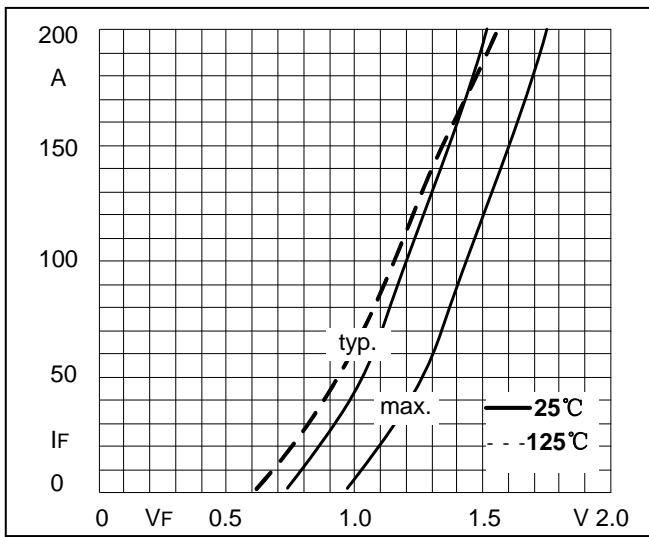

**Fig1. Forward Characteristics**

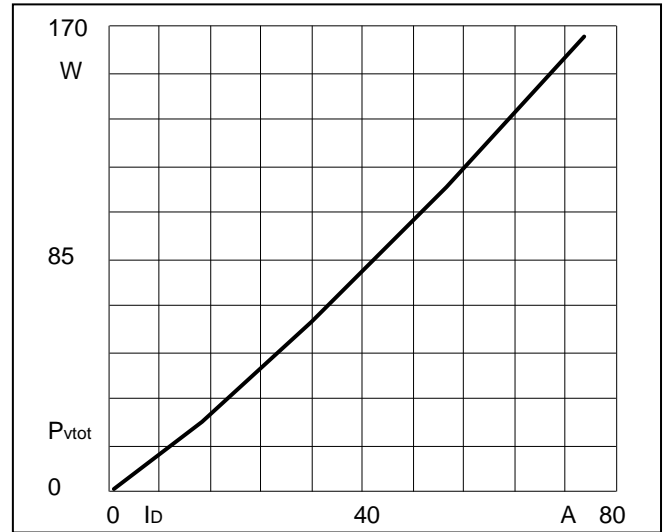

**Fig2. Power dissipation**

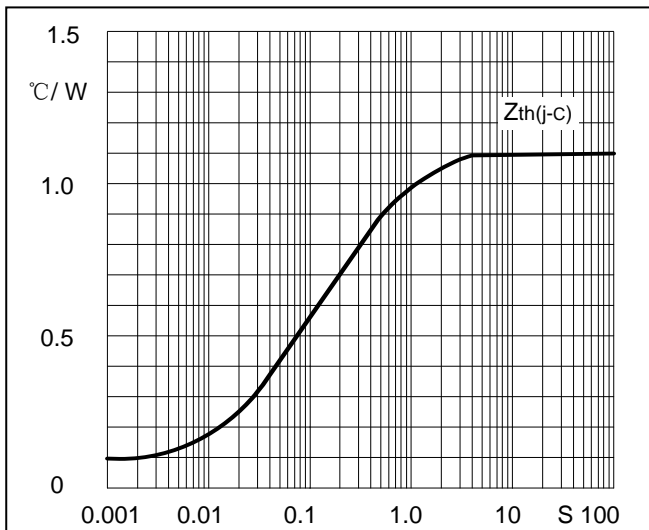

**Fig3. Transient thermal impedance**

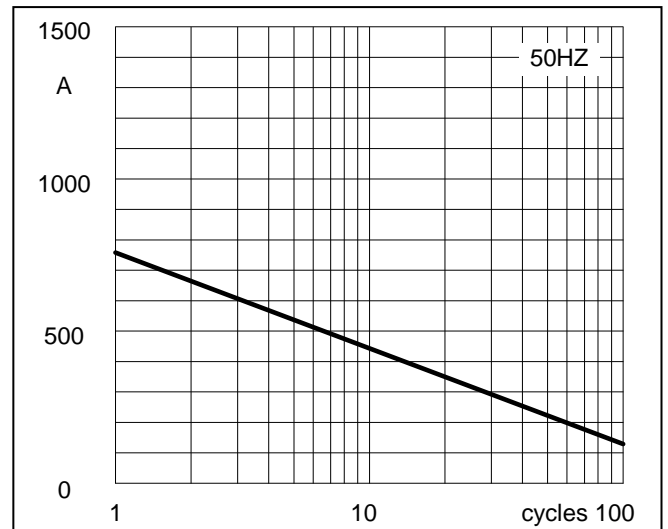

**Fig4. Max Non-Repetitive Forward Surge Current**

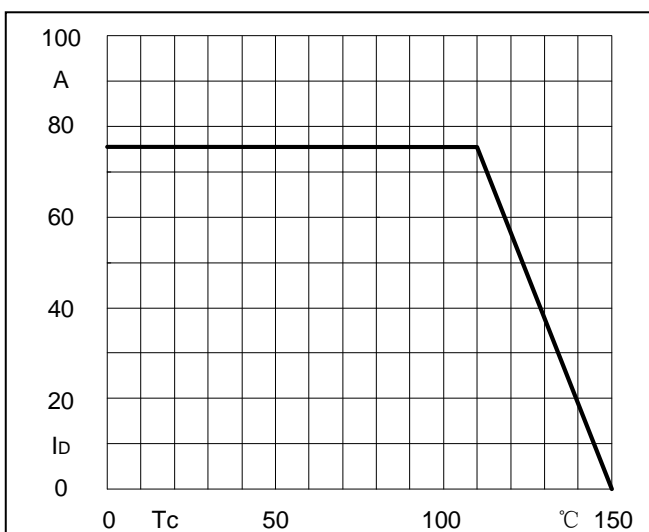

**Fig5. Forward Current Derating Curve**

Package Outline Information

CASE: M2

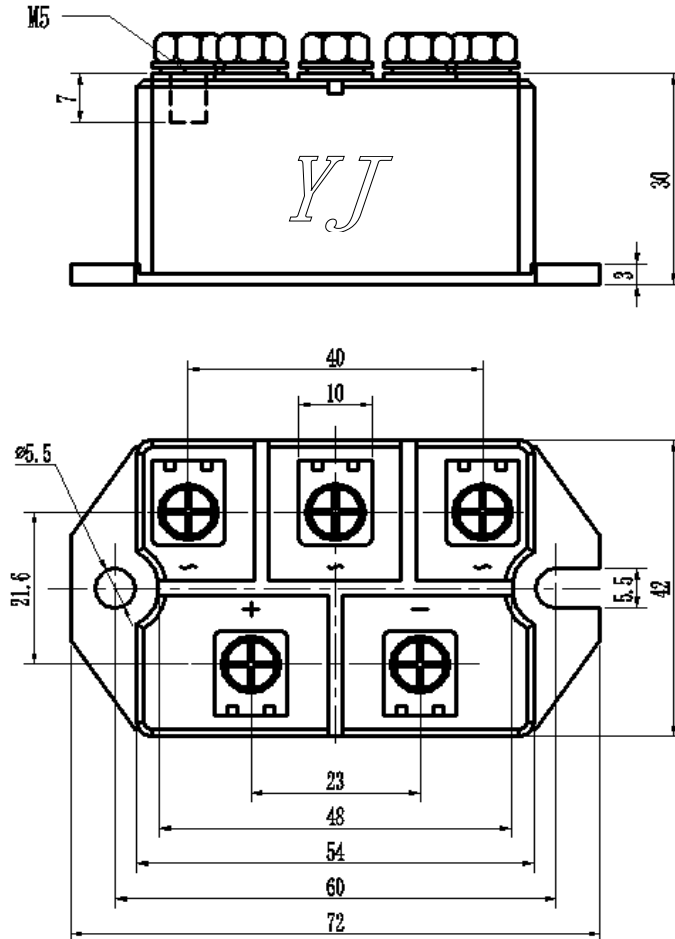

Dimensions in mm