



日昇電子科技有限公司
 深圳市丰华日昇科技有限公司

RI SHENG HI-TECH ELECTRICAL CO., LIMITED
 TEL: 0755-29663560 FAX: 0755-29648851

承认书
 Acknowledgment

CUSTOMER NAME 客户名称: _____
 CUSTOMER PARTS NO 客户料号: _____
 DESIGNATION 系列: _____
 MODEL NO 型号: ST-1114RAJ
 DRAWING NO 图型号: _____
 FORDRAWING ON 客户机种: _____

PLEASE CONFIRM OUR SPECIFICATION. 敬请确认规格书之内容。
 PLEASE CONFIRM AND RETURN TO US. 请确认后惠返 (1) 份。

APPROVAL STATUS 审批	
APPROVED 接受	FAILED 不接受
SIGNATURE 签署	DATE 日期

DGN 制表人	CKD校对	APPD审核	
刘丽	张伟		
DATE 日期/	DATE 日期/	DATE 日期/	NO

RI SHENG HI-TECH ELECTRICAL CO., LIMITED

P.C.B MOUNTING PATTERN DIMENSION
the following soldering are recommended
for reflow soldering

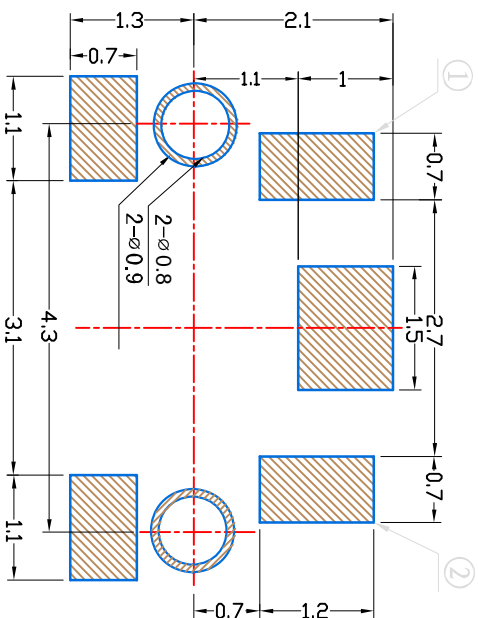
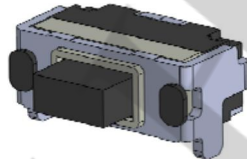
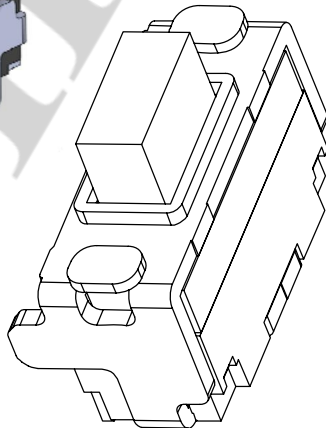
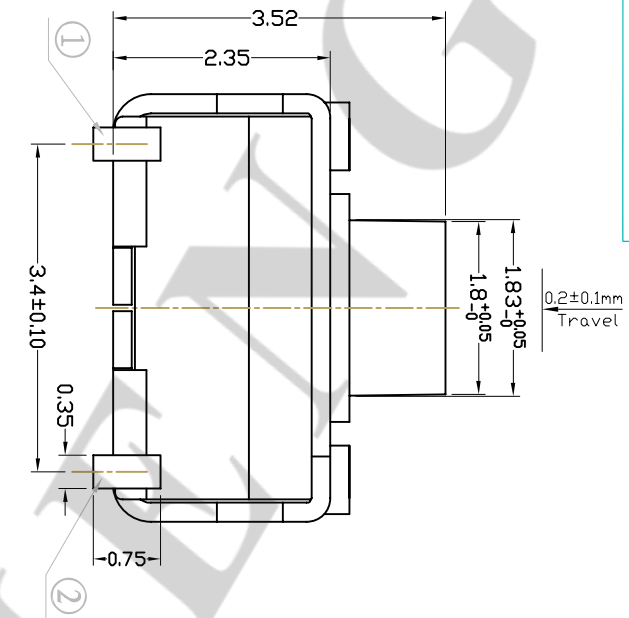

CIRCUIT DIAGRAM

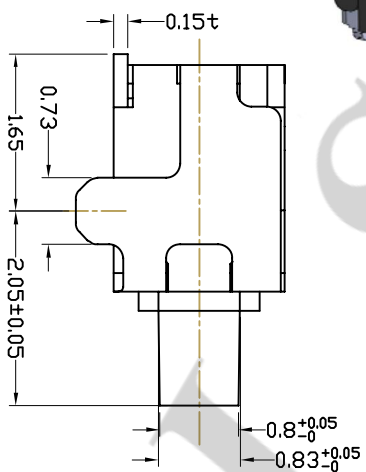
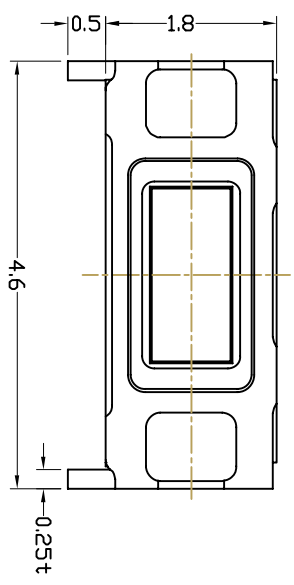

技术参数

NO	项目	参数
1	额定电流	50mA 12V DC
2	接触电阻	≤100mΩ
3	按压力	160±50gf
4	行程	0.2±0.1mm
5	绝缘电阻	>100MΩ
6	抗电强度	AC 250V 50Hz 1Min
7	寿命	100, 000 cyc

借(通)用件标记
描 图
描 校
旧底图总号
底图总号
签 字
日 期

未注公差

30<L ±0.30
10<L≤30 ±0.20
5<L≤10 ±0.15
L≤5 ±0.10
角 度 ±2°





日昇电子科技有限公司
RISHENG HI-TECH ELECTRICAL CO., LIMITED



产品名称
轻触开关
TACT SWITCH

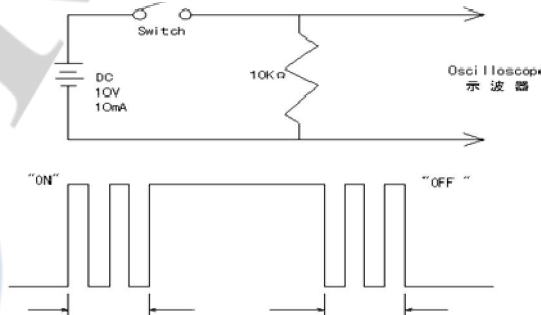

产品型号
ST-1114RAJ

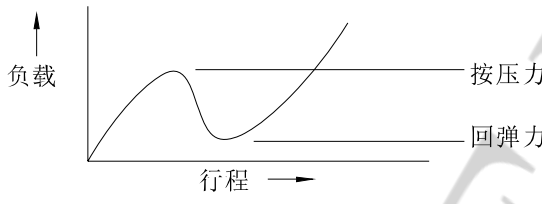
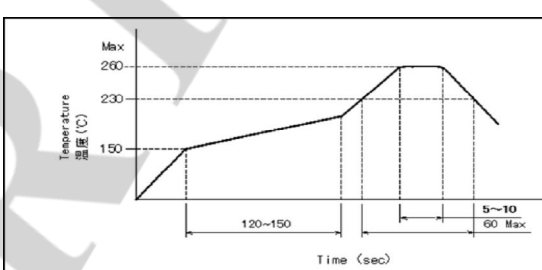

更改文件号	标记	日期	变更内容	担当	审核	批准	角 度	±2°	设计	审核	批准

设计	2012/12/14	单位	比例
		mm	5:1

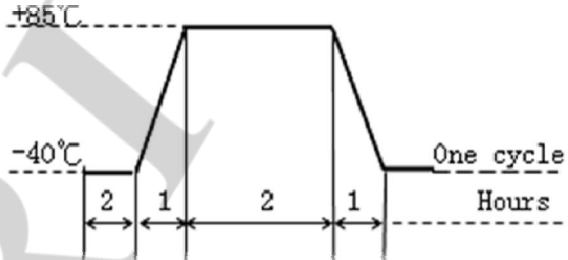
1. General specification 基本事项			
1.1 Switch action 开关种类: Tact Switch 轻触开关			
1.2 Switch rating 最大额定值: DC 12V, 50mA			
1.3 Operation temperature range 使用温度试验范围: -20℃~+85℃			
1.4 Preservative temperature range 保存温度范围: -40℃~+85℃			
1.5 Appearance and dimensions : See outside drawing page 外形尺寸: 见外形尺寸图			
1.6 Standard condition :Unless otherwise specified ,the test and measurements shall be carried out as follows :试验、测定状态 Ambient temperature 温度: 5~35℃ Relative humidity 相对湿度: 45~85% Air pressure 气压: 86~106kPa(860~1060mbar) However ,if doubt arises on the decision based on the measured Values under the above-mentioned conditions ,the following conditions be employed: 但是在对判定产生疑义时,按下述状态实施: Ambient temperature 温度: 20±2℃ Relative humidity 相对湿度: 65±5% Air pressure 气压: 86~106kPa(860~1060mbar)			
2. Performance 性能			
2.1 Electrical characteristics 电气性能			
	Item 项目	Test condition 测试条件	Performance 规格
2.1.1	Contact Resistance 接触电阻	Push force: (Operation force)X2。 测定时的负荷: 操作方向动作力基准值的 2 倍 Measurement tool: Contact resistance meter 测定器: 微电流接触电阻计 (1kHz,20mV,5~50mA)	100mΩ max. 100 毫欧以下。
2.1.2	Insulation Resistance 绝缘电阻	DC 250V(Between terminals) frame for 1 minute. 不相接的两端子间、端子与塑胶间施加 DC250V 电压,持续 1 分钟测量	100MΩ min. 100 兆欧以上。
2.1.3	Withstand Voltage 耐电压	AC 250V (Between terminals) frame for 1 minute. 不相接的两端子间、端子与塑胶间施加 AC250V 电压,持续 1 分钟测量	No insulation destruction 无绝缘破坏
2.1.4	Bouncing 触点抖动	Operation speed:3~4times/s 操作速度: 每秒 3~4 次 	ON: 3ms max 以下 OFF: 8ms max 以下
 日昇电子科技有限公司 RI SHENG HI-TECH ELECTRICAL CO., LIMITED		WRITTEN BY	CHECKED BY
			APPROVED BY

2.2 Mechanical Characteristics 机械性能				
Item 项目	Test condition 测试条件	Performance 规格		
2.2.1 Operations Force 动作力	Push by recommended operating condition. 测量时在开关的顶端的面中央、按开关动作方向均匀施加静负荷。 	Push force 按压力 $1.57 \pm 0.5N$ ($160 \pm 50gf$) Return force 回弹力 $0.5N$ ($50gf$ 最小)		
2.2.2 Travel to closure 运作行程	Push by recommended operating condition $F=(\text{Operation force}) \times 2$ 在开关的顶端的面中央沿开关动作方向施加2倍操作力测量行程，测量仪器的顶端应平。	$0.2 \pm 0.1mm$		
2.2.3 Push strength 按压强度	30N (3Kgf) for 1 minute 在开关驱动器件顶端中央，在按压力方向加30N (3Kgf)压力，作用60秒。	No damage(Electrical and mechanical) 无异常(电气、机械性能)		
2.2.4 Vibration test 耐振性	1) Amplitude 全振幅: 1.5mm 2) Sweep rate: 10-55-10Hz for 1 minute 扫描速度: 10-55-10Hz 1分钟 3) Sweep method: Logarithmic frequency sweep rate 扫描方式: 对数频率扫描速度 4) Vibration direction : X、Y、Z (3 directions) 振动方向: X、Y、Z (3方向) 5) Time: Each direction 2 hours (Total 6 hours) 时间: 每个方向2个小时(共6小时)	No.2.1 and 2.2.1 to 2.2.2 shall be satisfied 满足2.1项和2.2.1至2.2.2项。		
2.2.5 SOLDER HEAT RESISTANCE 回流焊接热试验	REFLOW SOLDERING: 	Without deformation of case or excessive looseness of electrical properties 本体无变形，能满足电气、机械性能。		
2.2.6 Solderability 可焊性	After sprated flux 涂上助焊剂后 temperature: $245 \pm 5^{\circ}C$ 温度: $245 \pm 5^{\circ}C$ Soldering time: $3 \pm 0.5sec$ 焊接时间: 3 ± 0.5 秒	90% or more of surface area of the portion immersed in solder shall be covered by new solder 90%或更多的浸焊面积能被焊锡覆盖		
 日昇电子科技有限公司 RI SHENG HI-TECH ELECTRICAL CO., LIMITED		WRITTEN BY	CHECKED BY	APPROVED BY

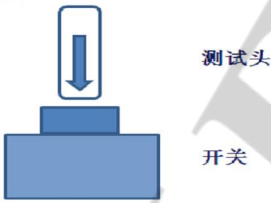
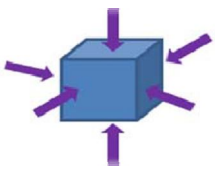
2.3 Climatic characteristics 耐候性能			
Item 项目	Test condition 测试条件	Performance 规格	
2.3.1 Cold test 耐寒性	1) Temperature: $-40\pm 2^{\circ}\text{C}$ 温度: $-40\pm 2^{\circ}\text{C}$ 2) Duration of test: 96h 持续时间: 96 小时 3) Take off a drop water 去掉水珠 4) Standard conditions after test:1h 试验后的放置条件: 1 小时	Contact resistance : 200m Ω max 接触电阻: 200 m Ω 以下 Insulation resistance: 100M Ω min 绝缘电阻: DC. 250V, 大于 100M Ω Withstand voltage :No. destruction. 耐电压: 无绝缘破坏。 No. 2. 2. 1 to 2. 2. 2 shall be satisfied 满足 2. 2. 1 到 2. 2. 2 项。	
2.3.2 Heat test 耐热性	1) Temperature: $80\pm 2^{\circ}\text{C}$ 温度: $80\pm 2^{\circ}\text{C}$ 2) Duration of test: 96h 持续时间: 96 小时 3) Standard conditions after test :1h 试验后的放置条件: 1 小时	Contact resistance : 200m Ω max 接触电阻: 200 m Ω 以下 Insulation resistance: 100M Ω min 绝缘电阻: DC. 250V, 大于 100M Ω Withstand voltage :No. destruction. 耐电压: 无绝缘破坏。 No. 2. 2. 1 to 2. 2. 2 shall be satisfied 满足 2. 2. 1 到 2. 2. 2 项。	
2.3.3 TEMPERATURE CYCLIG TEST 温度交变试验	According to following figure, after 5cycles, test after keeping in normal condition for 30min. 如图示环境中, 循环 5 次后, 放置在正常环境中, 1 小时后进行测量。 	Contact resistance : 200m Ω max 接触电阻: 200 m Ω 以下 Insulation resistance: 100M Ω min 绝缘电阻: DC. 250V, 大于 100M Ω Withstand voltage :No. destruction. 耐电压: 无绝缘破坏。 No. 2. 2. 1 to 2. 2. 2 shall be satisfied 满足 2. 2. 1 到 2. 2. 2 项	
2.3.4 Humidity test 耐湿性	1) Temperature: $60\pm 2^{\circ}\text{C}$ 温度: $60\pm 2^{\circ}\text{C}$ 2) Relative humidity:90~95% 相对湿度: 90~95% 3) Duration of test: 96h 持续时间: 96 小时 4) Take off a drop water 去掉水珠 5) Standard conditions after test:1h 试验后的放置条件: 1 小时	Contact resistance : 200m Ω max 接触电阻: 200 m Ω 以下 Insulation resistance: 100M Ω min 绝缘电阻: DC. 250V, 大于 100M Ω Withstand voltage :No. destruction. 耐电压: 无绝缘破坏。 No. 2. 2. 1 to 2. 2. 2 shall be satisfied 满足 2. 2. 1 到 2. 2. 2 项	
 日昇电子科技有限公司 RI SHENG HI-TECH ELECTRICAL CO., LIMITED	WRITTEN BY	CHECKED BY	APPROVED BY

Item 项目		Test condition 测试条件	Performance 规格	
2.3.5	Endurance (switching) action 耐久特性(开关寿命)	1) Operation speed: 1time/s 动作速度: 1次/秒 2) Push force: Maximum value of operation force 按力: 动作力规格值的上限 3) Operation number: 100, 000 times 动作次数: 100, 000次 安装示意图 	Contact resistance : 200mΩ max 接触电阻: 200 mΩ 以下 Bouncing : 10 ms max 触点抖动: 10 毫秒以下 Insulation resistance: 100MΩ min 绝缘电阻: DC. 250V, 大于 100MΩ Withstand voltage :No. destruction. 耐电压: 无绝缘破坏。 Variations rate of operation force shall be within ±30% to the value before testing 动作力的变化范围在初始值的±30%以内 2.2.2 shall be satisfied 满足 2.2.2 项	
2.3.6	Withstand H2S 耐 H2S	1) Density: 3±1ppm 浓度: 3±1ppm 1) Temperature: 40±2℃ 温度: 40±2℃ 2) Relative humidity:90~95% 相对湿度: 90~95% 3) Duration of test: 12h 持续时间: 12 小时 4) Standard conditions after test:1h 试验后的放置条件: 1 小时	Contact resistance : 200mΩ max 接触电阻: 200 mΩ 以下 Insulation resistance: 100MΩ min 绝缘电阻: DC. 250V, 大于 100MΩ Withstand voltage :No. destruction. 耐电压: 无绝缘破坏。 No.2.2.1 to 2.2.2 shall be satisfied 满足 2.2.1 到 2.2.2 项	
2.3.7	Salt mist 雾实验	At 5% Nacl liquor for 24 hours depend on 35℃, after washing ,keep in normal condition. 5% 的 Nacl 溶液, PH 值: 6.5~7.2, 在 35℃ 的条件下喷雾。铜材 24 小时, 铁材 8 小时。用清水洗干净后并在室温下晾干	No remarkable corrosion shall be recognized in metal part. 在金属件上没有腐蚀斑点。	
2.3.8	Shock 耐冲击性	Peak acceleration: 500m/S ² 冲击加速度: 500m/S ² 脉冲持续时间 11ms Test time-6direction, each 3 times total 18 times 测试次数-6 个方向, 各 3 次共计 18 次 	Contact resistance : 200mΩ max 接触电阻: 200 mΩ 以下 Insulation resistance: 100MΩ min 绝缘电阻: DC. 250V, 大于 100MΩ Withstand voltage :No. destruction. 耐电压: 无绝缘破坏。 No.2.2.1 to 2.2.2 shall be satisfied 满足 2.2.1 到 2.2.2 项	
 日昇电子科技有限公司 RI SHENG HI-TECH ELECTRICAL CO., LIMITED		WRITTEN BY	CHECKED BY	APPROVED BY

3. Precaution 注意事项			
3.1 Soldering condition 浸焊条件			
Item 项目	Condition 测试条件		
Preheat temperature 预热温度	110°C max (Embilmental temperature of soldering surface of P.C.B) 110°C 以下 (印刷基板焊锡周围的温度)		
Preheat time 预热时间	60 sec, max 60 秒以内		
Area of flux 助焊剂面积	1/2 max of P.C.B. thickness 印刷基板厚度的 1/2 以内		
Temperature of solder 焊锡温度	260±5°C max 260±5°C 以下		
Times of immersion 浸焊时间	Within 5 sec 5 秒以内		
Soldering number 浸焊次数	Within 2 times (But should bring down heat of the first soldering) 2 次以内 (但应把第一次焊锡的温度降下来)		
Printed wiring board 印刷基板	Single sided copper- clad laminates 单面铜箔		
<p>1) After switches were soldered, please be careful not to clean switches with solvent 开关浸焊后, 注意不要用溶剂清洗。</p> <p>2) In the case of using soldering iron, soldering conditions shall be 280°C max and 3 sec max. 在使用烙铁的情况下, 焊锡温度应在 280°C 以下、3 秒以内。</p> <p>3) Right after switches were soldered; please be careful not to load on the knobs of switches. 浸焊后, 注意不要在手柄顶部施加负荷。</p>			
3.2 Design instructions (设计中应注意事项)			
1) Follow recommended P.C.B. piercing plan in the outside drawing page. 印刷基板的安装孔尺寸参见产品图			
3.3 Note (注意点)			
1) Please be cautious not to give excessive static load or shock to switches. 注意不要施加超过负荷的压力或晃动开关。			
2) Please be careful not to pile up P.C.B. after switches were soldered. 开关焊接以后, 印刷基板注意不要叠放。			
3) Preservation under high temperature and high humidity or corrosive gas should be avoided especially. When you need to preserve for a long period, do not open the carton. 保管时尤其应注意避开高湿高温和有腐蚀性气体的环境, 如需长时间保存, 请不要打开包装箱。			
4) SMT 焊接时, 刷锡厚度应控制在 0.11 mm 以内。 SMT were soldered., thickness control 0.11 mm MAX			
 日昇电子科技有限公司 RI SHENG HI-TECH ELECTRICAL CO., LIMITED	WRITTEN BY	CHECKED BY	APPROVED BY

4. Specification 材质

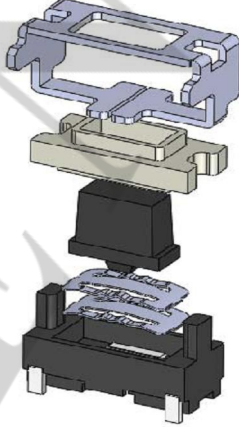
NO	Part Name 名称	QTY 数量	Material 颜色	Specification 材质	Photos 照片
1	盖板	1	银白色	磷铜镀银	
2	按钮	1	黑色	LCP	
3	塑盖	1	白色	LCP	
4	簧片	2	木色	不锈钢覆银	
5	基座	1	黑色	LCP	
6	端子	1	银白色	磷铜镀银	

5.Reel page 编带尺寸

