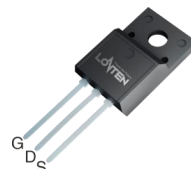
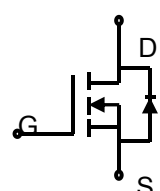

Lonten N-channel 550V, 23A, 0.14Ω LonFET™ Power MOSFET

<p>Description LonFET™ Power MOSFET is fabricated using advanced super junction technology. The resulting device has extremely low on resistance, making it especially suitable for applications which require superior power density and outstanding efficiency.</p> <p>Features</p> <ul style="list-style-type: none"> ◆ Ultra low $R_{DS(on)}$ ◆ Ultra low gate charge (typ. $Q_g = 40\text{nC}$) ◆ 100% UIS tested ◆ RoHS compliant <p>Applications</p> <ul style="list-style-type: none"> ◆ Power factor correction (PFC). ◆ Switched mode power supplies (SMPS). ◆ Uninterruptible power supply (UPS). 	<p>Product Summary</p> <table> <tr> <td>$V_{DS} @ T_{j,max}$</td> <td>600V</td> </tr> <tr> <td>$R_{DS(on),max}$</td> <td>0.14Ω</td> </tr> <tr> <td>I_{DM}</td> <td>69A</td> </tr> <tr> <td>$Q_{g,typ}$</td> <td>40nC</td> </tr> </table> <div style="text-align: center;">  <p>TO-220NF</p>  <p>N-Channel MOSFET</p> </div>	$V_{DS} @ T_{j,max}$	600V	$R_{DS(on),max}$	0.14Ω	I_{DM}	69A	$Q_{g,typ}$	40nC
$V_{DS} @ T_{j,max}$	600V								
$R_{DS(on),max}$	0.14Ω								
I_{DM}	69A								
$Q_{g,typ}$	40nC								

Absolute Maximum Ratings

Parameter	Symbol	Value	Unit
Drain-Source Voltage	V_{DSS}	550	V
Continuous drain current ($T_C = 25^\circ\text{C}$)	I_D	23	A
($T_C = 100^\circ\text{C}$)		15	A
Pulsed drain current ¹⁾	I_{DM}	69	A
Gate-Source voltage	V_{GSS}	± 30	V
Avalanche energy, single pulse ²⁾	E_{AS}	600	mJ
Power Dissipation ($T_C = 25^\circ\text{C}$)	P_D	34	W
- Derate above 25°C		0.28	W/ $^\circ\text{C}$
Operating and Storage Temperature Range	T_J, T_{STG}	-55 to +150	$^\circ\text{C}$
Continuous diode forward current	I_S	23	A
Diode pulse current	$I_{S,pulse}$	69	A

Thermal Characteristics

Parameter	Symbol	Value	Unit
Thermal Resistance, Junction-to-Case	$R_{\theta JC}$	3.6	$^\circ\text{C}/\text{W}$
Thermal Resistance, Junction-to-Ambient	$R_{\theta JA}$	80	$^\circ\text{C}/\text{W}$
Soldering temperature, wavesoldering only allowed at leads. (1.6mm from case for 10s)	T_{solid}	260	$^\circ\text{C}$

Package Marking and Ordering Information

Device	Device Package	Marking	Units/Tube
LSDN55R140GT	TO-220NF	LSDN55R140GT	50

Electrical Characteristics
 $T_c = 25^\circ\text{C}$ unless otherwise noted

Parameter	Symbol	Test Condition	Min.	Typ.	Max.	Unit
Static characteristics						
Drain-source breakdown voltage	BV_{DSS}	$V_{GS}=0\text{ V}, I_D=0.25\text{ mA}$	550	-	-	V
Gate threshold voltage	$V_{GS(th)}$	$V_{DS}=V_{GS}, I_D=0.25\text{ mA}$	2.5	3.5	4.5	V
Drain cut-off current	I_{DSS}	$V_{DS}=550\text{ V}, V_{GS}=0\text{ V}, T_j = 25^\circ\text{C}$	-	-	1	μA
Gate leakage current, Forward	I_{GSSF}	$V_{GS}=30\text{ V}, V_{DS}=0\text{ V}$	-	-	100	nA
Gate leakage current, Reverse	I_{GSSR}	$V_{GS}=-30\text{ V}, V_{DS}=0\text{ V}$	-	-	-100	nA
Drain-source on-state resistance	$R_{DS(on)}$	$V_{GS}=10\text{ V}, I_D=11.5\text{ A}$ $T_j = 25^\circ\text{C}$ $T_j = 150^\circ\text{C}$	-	0.11 0.29	0.14	Ω
Gate resistance	R_G	$f=1\text{ MHz}, \text{open drain}$	-	4.5	-	Ω
Dynamic characteristics						
Input capacitance	C_{iss}	$V_{DS} = 100\text{ V}, V_{GS} = 0\text{ V},$ $f = 250\text{ kHz}$	-	1730	-	μF
Output capacitance	C_{oss}		-	76.2	-	
Reverse transfer capacitance	C_{rss}		-	4.1	-	
Turn-on delay time	$t_{d(on)}$	$V_{DD} = 400\text{ V}, I_D = 11.5\text{ A}$ $R_G = 10\ \Omega, V_{GS}=10\text{ V}$	-	19	-	ns
Rise time	t_r		-	27	-	
Turn-off delay time	$t_{d(off)}$		-	99	-	
Fall time	t_f		-	10	-	
Gate charge characteristics						
Gate to source charge	Q_{gs}	$V_{DD}=440\text{ V}, I_D=11.5\text{ A},$ $V_{GS}=0\text{ to }10\text{ V}$	-	10	-	nC
Gate to drain charge	Q_{gd}		-	14	-	
Gate charge total	Q_g		-	40	-	
Gate plateau voltage	$V_{plateau}$		-	5.5	-	V
Reverse diode characteristics						
Diode forward voltage	V_{SD}	$V_{GS}=0\text{ V}, I_F=11.5\text{ A}$	-	-	1.2	V
Reverse recovery time	t_{rr}	$V_R=50\text{ V}, I_F=23\text{ A},$ $di_F/dt=100\text{ A}/\mu\text{s}$	-	363	-	ns
Reverse recovery charge	Q_{rr}		-	4	-	μC
Peak reverse recovery current	I_{rrm}		-	21	-	A

Notes:

- Limited by maximum junction temperature, maximum duty cycle is 0.75.
- $I_{AS} = 5\text{ A}, V_{DD} = 60\text{ V}, \text{Starting } T_j = 25^\circ\text{C}.$

Electrical Characteristics Diagrams

Figure 1. On-Region Characteristics

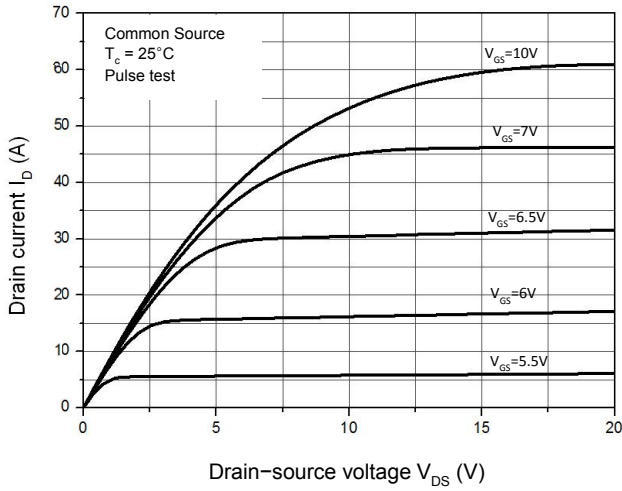

Figure 2. Transfer Characteristics

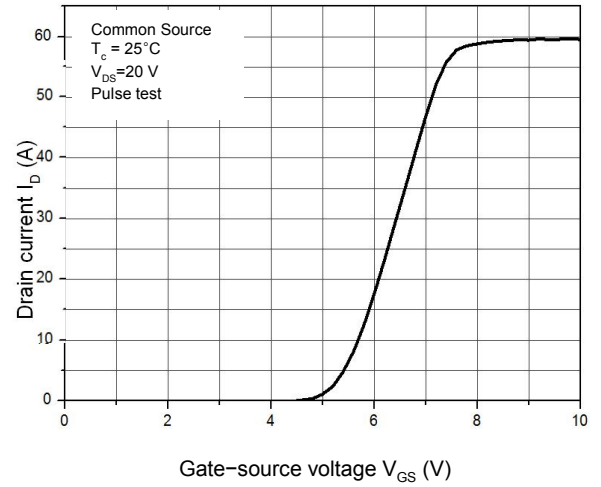

Figure 3. On-Resistance Variation vs. Drain Current

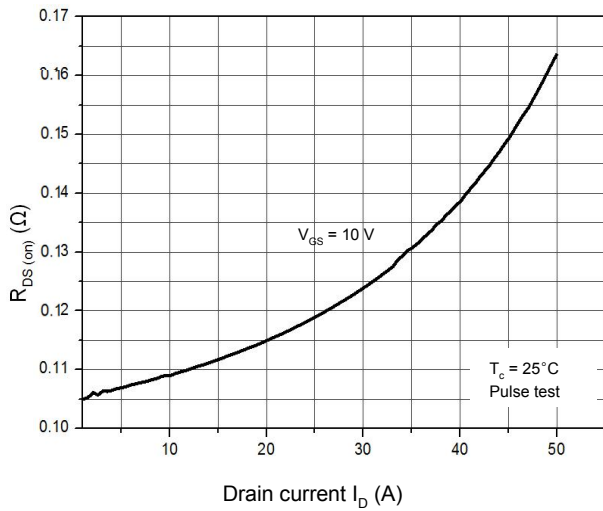

Figure 4. Threshold Voltage vs. Temperature

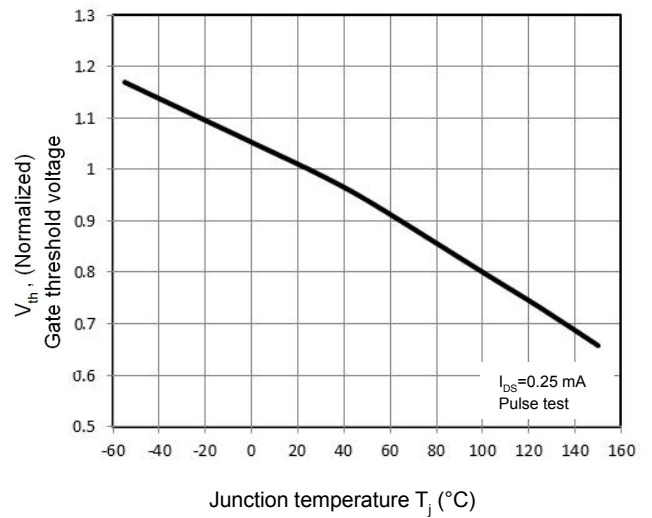

Figure 5. Breakdown Voltage vs. Temperature

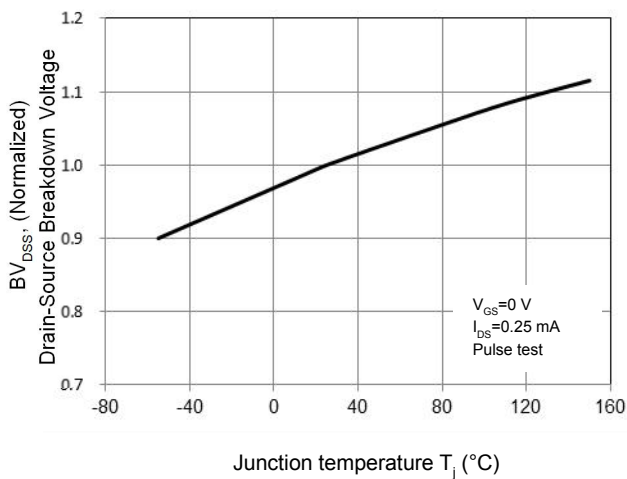

Figure 6. On-Resistance vs. Temperature

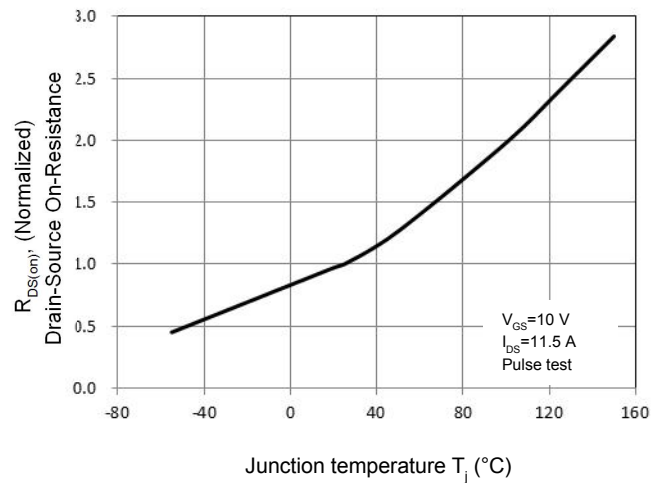

Figure 7. Capacitance Characteristics

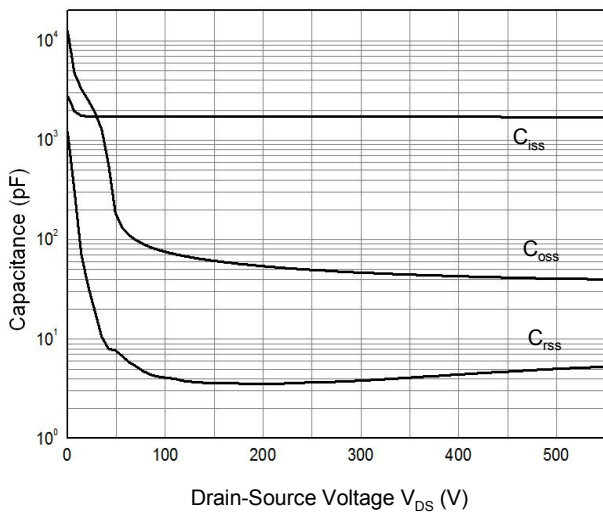

Figure 8. Gate Charge Characteristics

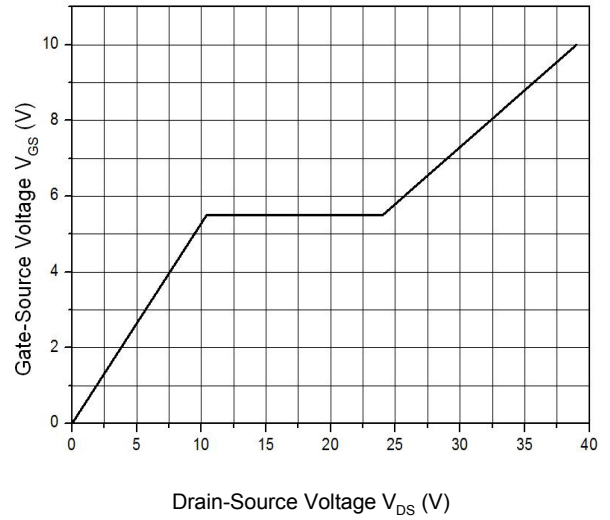

Figure 9. Power Dissipation vs. Temperature

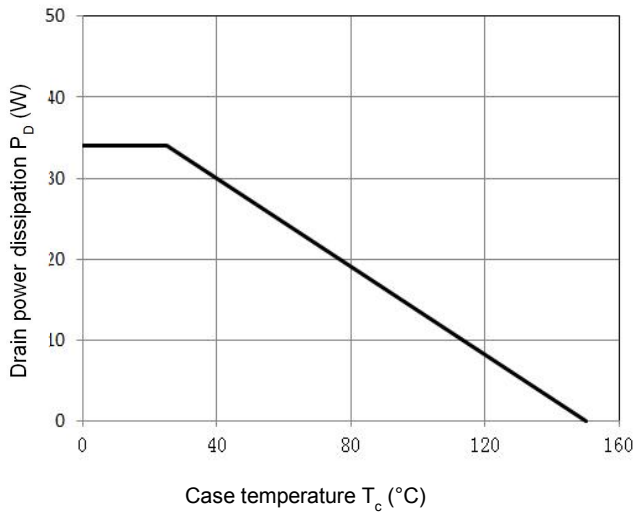

Figure 10. Drain Current Derating

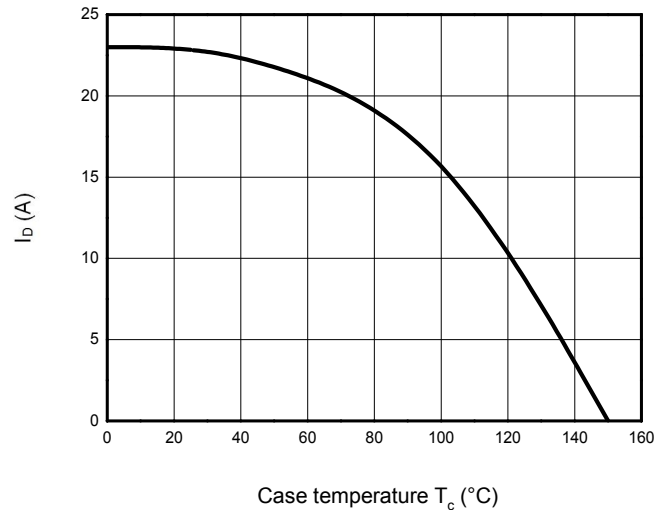

Figure 11: Safe Operating Area

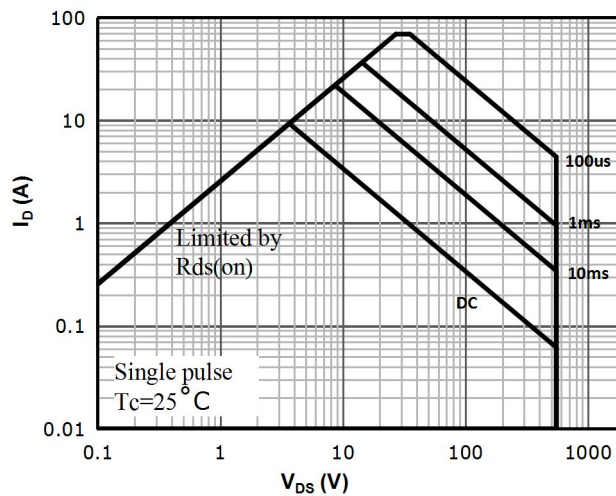
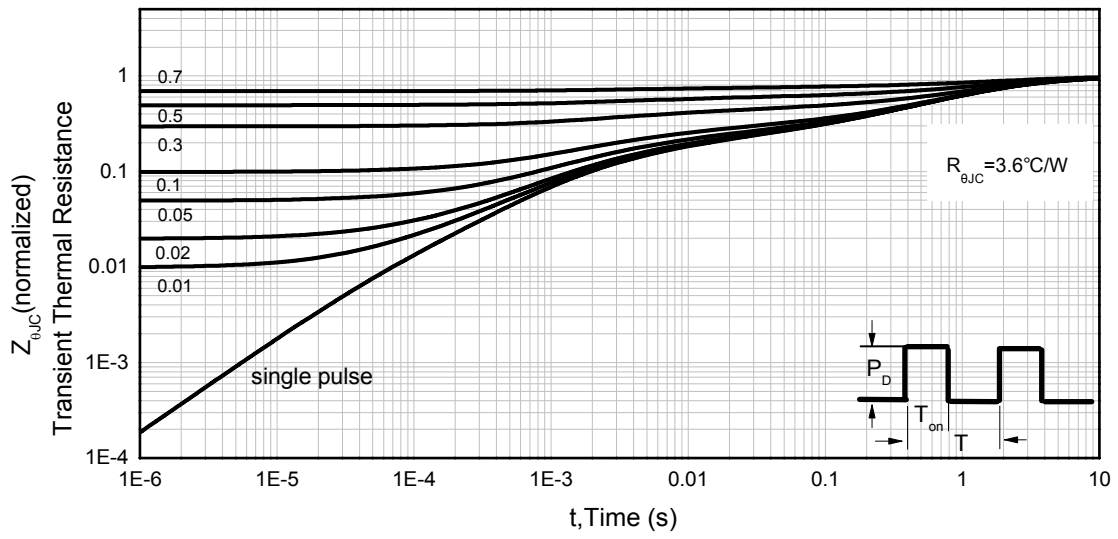
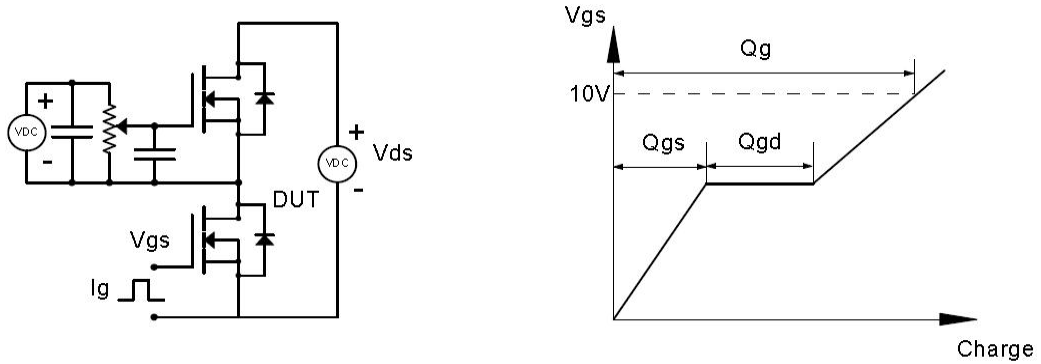

Figure 12. Transient Thermal Response Curve



Test Circuit & Waveforms

Gate Charge Test Circuit & Waveform



Resistive Switching Test Circuit & Waveforms

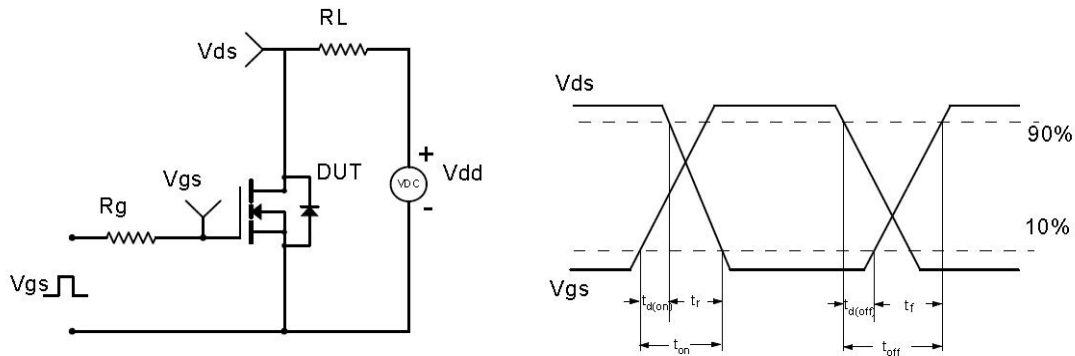

Unclamped Inductive Switching (UIS) Test Circuit & Waveforms

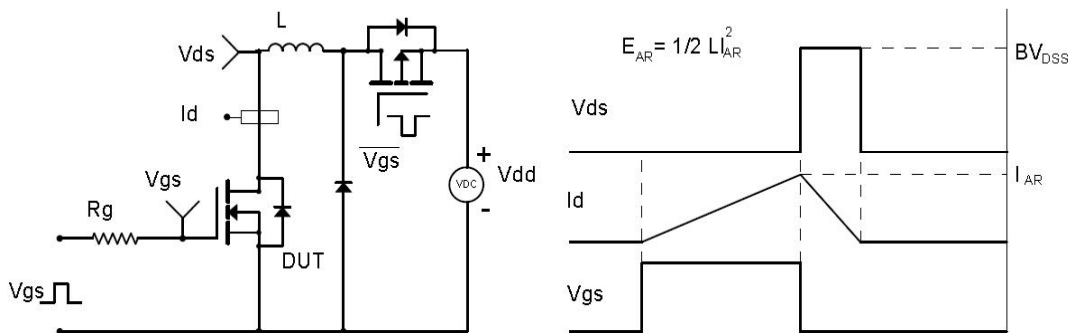

Mechanical Dimensions for TO-220NF

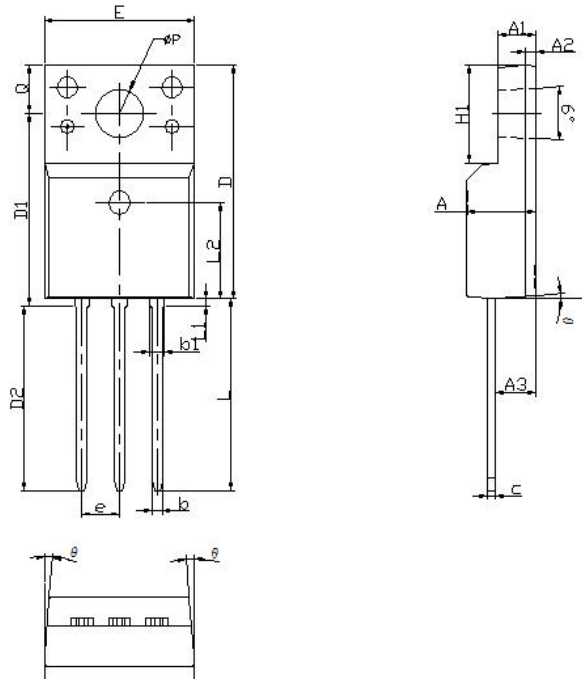

DIMENSIONS IN MILLIMETERS			DIMENSIONS IN INCHES	
SYMBOL	MIN	MAX	MIN	MAX
A	4.3	4.83	0.169	0.190
A1	2.34	2.9	0.092	0.114
A2	0.70REF		0.028REF	
A3	2.56	2.93	0.101	0.115
b	0.59	0.8	0.023	0.031
b1	-	1.1	-	0.043
c	0.45	0.79	0.018	0.031
D	14.7	16.07	0.579	0.633
D1	12.87	13.27	0.507	0.522
D2	12.28	12.68	0.483	0.499
E	9.7	10.36	0.382	0.408
e	2.54BSC		0.1BSC	
H1	6.48	7.1	0.255	0.280
L	12.68	13.35	0.499	0.526
L1	-	0.85	-	0.033
L2	6.50REF		0.256REF	
φP	3.05	3.4	0.120	0.134
Q	2.7	3.4	0.106	0.134
θ	1°	5°	1°	5°

Disclaimer

The content specified herein is for the purpose of introducing LONTEN's products (hereinafter "Products"). The information given in this document shall in no event be regarded as a guarantee of conditions or characteristics. Examples of application circuits, circuit constants and any other information contained herein illustrate the standard usage and operations of the Products. The peripheral conditions must be taken into account when designing circuits for mass production.

LONTEN does not assume any liability for infringement of patents, copyrights, or other intellectual property rights of third parties by or arising from the use of the Products or technical information described in this document.

The Products are not designed or manufactured to be used with any equipment, device or system which requires an extremely high level of reliability the failure or malfunction of which may result in a direct threat to human life or create a risk of human injury (such as a medical instrument, transportation equipment, aerospace machinery, nuclear-reactor controller, fuel-controller or other safety device). LONTEN shall bear no responsibility in any way for use of any of the Products for the above special purposes.

Although LONTEN endeavors to improve the quality and reliability of its products, semiconductor products have specific characteristics such as the occurrence of failure at a certain rate and malfunctions under certain use conditions. Please be sure to implement safety measures to guard them against the possibility of physical injury, and injury or damage caused by fire in the event of the failure of a LONTEN product.

The content specified herein is subject to change for improvement without notice. When using a LONTEN product, be sure to obtain the latest specifications.