

## Low Capacitance ESD TVS Array in DFN3020

### Features

- 1000Watts peak pulse power ( $t_p = 8/20\mu s$ )
- DFN3020 package
- Unidirectional configurations
- Solid-state silicon-avalanche technology
- Low clamping voltage
- Low leakage current
- Low capacitance (1.7pF typical I/O to I/O)
- ESD Protection for high-speed data lines to:
  - IEC 61000-4-2  $\pm 30KV$  contact  $\pm 30KV$  air
  - IEC 61000-4-4 (EFT) 40A (5/50ns)
  - IEC 61000-4-5 (Lightning) 40A (8/20 $\mu s$ )

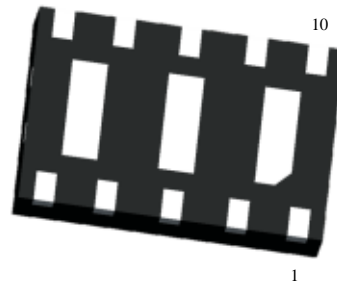

### Mechanical Data

- **Case:** DFN3020 (plastic package).  
Lead free; RoHS compliant
- **Molding Compound Flammability Rating:**  
UL 94 V-0
- **Terminals:** High temperature soldering guaranteed:  
260 °C/10 sec. at terminals

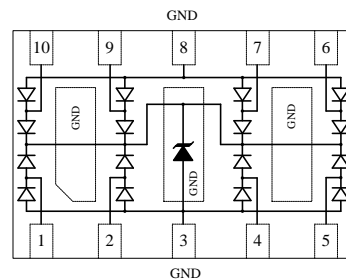

### Applications

- 10/100/1000M Ethernet Ports
- WAN/LAN Equipment
- Desktops, Servers and Notebooks
- Cellular Phones
- Switching Systems
- Audio/Video Inputs

### Absolute Maximum Ratings

Ratings at 25 °C, ambient temperature unless otherwise specified

Parameter	Symbol	Value	Unit
Peak Pulse Power ( $T_P=8/20\mu S$ )	$P_{PP}$	1000	W
ESD contact/air discharge (IEC-61000-4-2)	$V_{ESD}$	30/30	kV
Peak Pulse Current ( $t_p = 8/20\mu S$ )	$I_{PP}$	40	A
Junction Temperature	$T_J$	-55 to +125	°C
Storage temperature	$T_{STG}$	-55 to +150	°C

Symbol	Parameter
$V_{RWM}$	Nominal Reverse Working Voltage
$I_R$	Reverse Leakage Current @ $V_{RWM}$
$V_{t1}$	Trigger Voltage
$I_{t1}$	Trigger Current @ $V_{t1}$
$V_h$	Holding Voltage
$I_h$	Holding Current @ $V_h$
$V_C$	Clamping Voltage @ $I_{PP}$
$I_{PP}$	Maximum Peak Pulse Current
$C_{ESD}$	Parasitic Capacitance

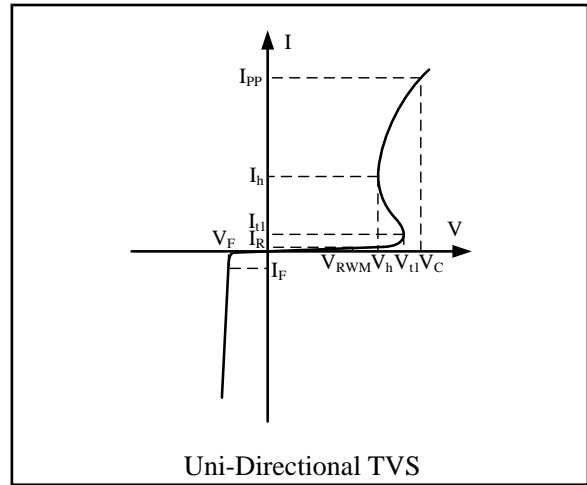

## Electrical Characteristics

( $T_A = 25^\circ\text{C}$  unless otherwise specified)

Symbol	Test Condition	Minimum	Typical	Maximum	Units
$V_{RWM}$				3.3	V
$I_R$	$V_{RWM} = 3.3\text{V}, T = 25^\circ\text{C}$		0.1	1.0	$\mu\text{A}$
$V_{t1}$	$I_{t1} = 1\mu\text{A}$	3.8	4.5	5.5	V
$V_h$	$I_h = 1\text{mA}$	3.5		5.5	V
$V_C$	Any I/O to Ground $I_{PP} = 1\text{A}, t_p = 8/20\mu\text{s}$			5.5	V
$V_C$	Any I/O to Ground $I_{PP} = 10\text{A}, t_p = 8/20\mu\text{s}$			10.5	V
$V_C$	Any I/O to Ground $I_{PP} = 25\text{A}, t_p = 8/20\mu\text{s}$			18.0	V
$V_C$	Line-to-Line / Line-to-GND, two I/O Pins connected together on each line $I_{PP} = 40\text{A}, t_p = 8/20\mu\text{s}$			25.0	V
$C_{ESD}$	Between I/O Pins and Ground $V_R = 0\text{V}, f = 1\text{MHz}$		3.8	5.0	pF
$C_{ESD}$	Between I/O Pins $V_R = 0\text{V}, f = 1\text{MHz}$		1.7	2.5	pF

**Typical Characteristics** ( $T_{amb} = 25\text{ }^{\circ}\text{C}$  unless otherwise specified)

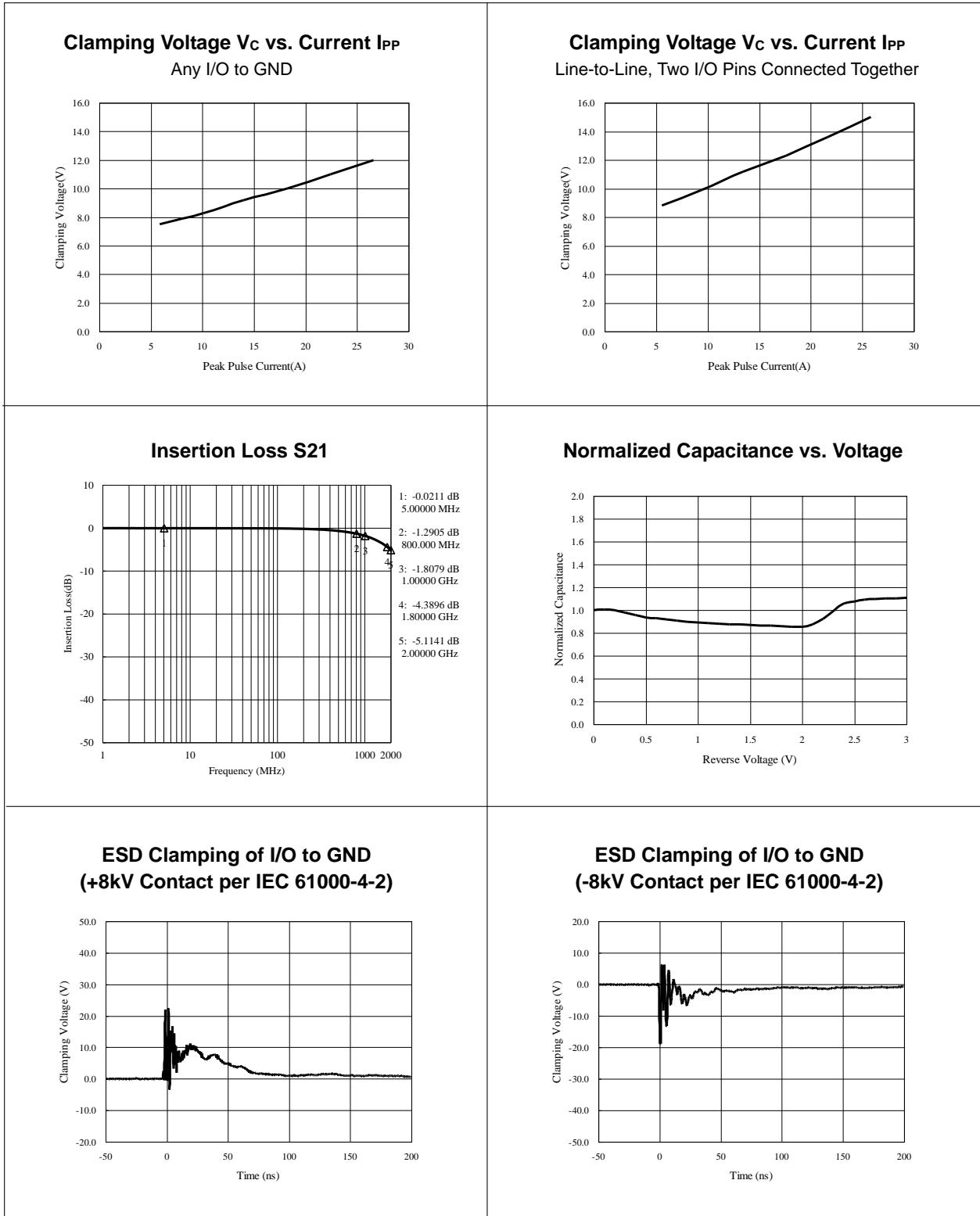

## Package Dimensions

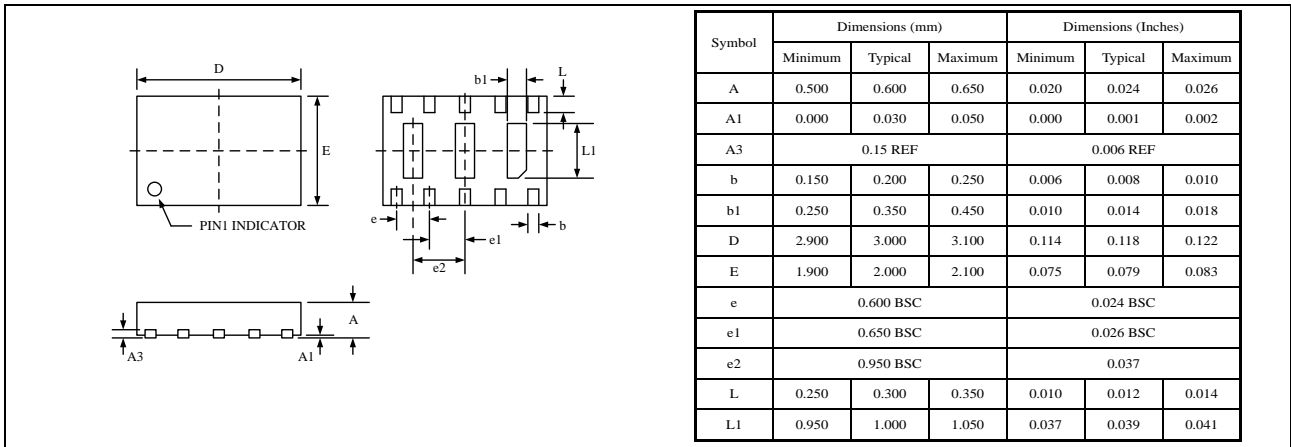

## Part number system

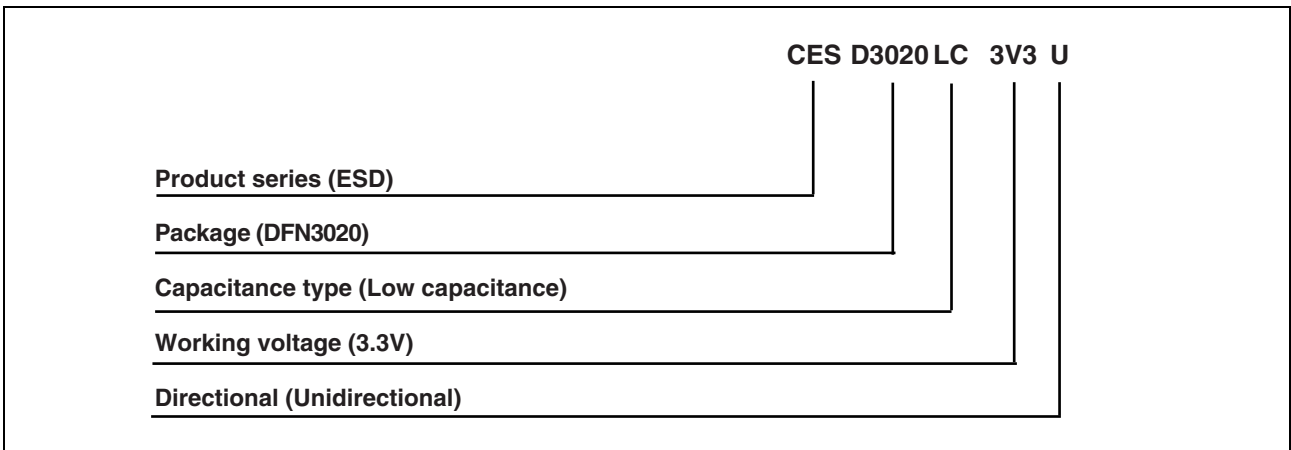

## Marking

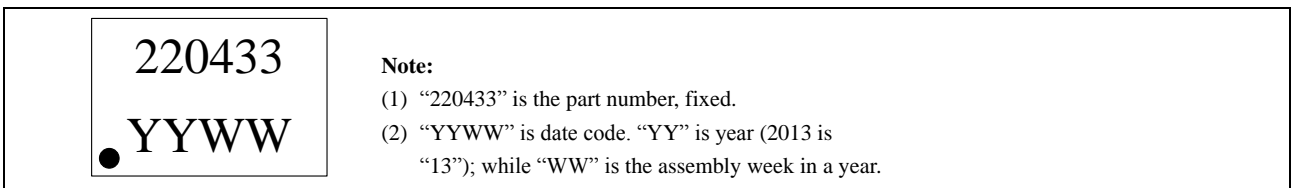

## Ordering information

Order code	Package	Packaging option	Base quantity	Packaging specification
CESD3020LC3V3U	DFN3020	Tape and reel	3000pcs / reel	EIA STD RS-481

## Revision history

Date	Revision	Changes
23-May-2012	1.0	Initial release

## **CAUTION / WARNING**

Information in this document is believed to be accurate and reliable. However, CREATEK does not give any representations or warranties, expressed or implied, as to the accuracy or completeness of such information and shall have no liability for the consequences of use of such information.

Users should independently evaluate the suitability of and test each product selected for their own applications, and CREATEK assumes no liability whatsoever relating to the choice, selection or use of the CREATEK products and services described herein.

CREATEK reserves the right to change or update, without notice, any information contained in this publication; to change, without notice, the design, construction, processing, or specification of any product; and to discontinue or limit production or distribution of any product.

Information in this document supersedes and replaces all information previously supplied.

Products are not designed, authorized or warranted to be suitable for use in medical, military, aircraft, space or life support equipment, nor in applications where failure or malfunction of an CREATEK product can reasonably be expected to result in personal injury, death or severe property or environmental damage. CREATEK accepts no liability for inclusion and/or use of CREATEK products in such equipment or applications and therefore such inclusion and/or use is at the customer's own risk.

This document as well as the item(s) described herein may be subject to export control regulations. Export might require a prior authorization from national authorities.

Resale of CREATEK products with provisions different from the statements and/or technical features set forth in this document shall immediately void any warranty granted by CREATEK for the CREATEK product or service described herein and shall not create or extend in any manner whatsoever, any liability of CREATEK.

CREATEK expressly disclaims all implied warranties regarding the information contained herein, including, but not limited to, any implied warranties of merchantability or fitness for a particular purpose. CREATEK only obligations are those in the CREATEK Standard Terms and Conditions of Sale and in no case will CREATEK be liable for any incidental, indirect, or consequential damages arising from the sale, resale, use, or misuse of its products.

---

Specifications are subject to change without notice

© Copyright 2009, CREATEK Microelectronics

 CREATEK® is a registered trademark of CREATEK Microelectronics

All rights reserved