

SMD Power Inductor

HPC6045NF-Series

ECN HISTORY LIST

REV	DATE	DESCRIPTION	APPROVED	CHECKED	DRAWN
1.0	16/08/11	新發行	楊祥忠	詹偉特	何秦芝
備註					

SMD Power Inductor

HPC6045NF-Series

1. Features

1. This specification applies Low Profile Power Inductors.
2. 100% Lead(Pb) & Halogen-Free and RoHS compliant.



2. Dimension

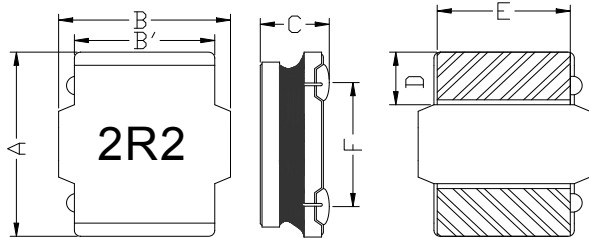

Recommended Land pattern

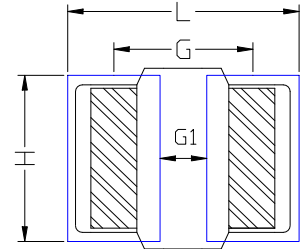

Series	A(mm)	B(mm)	B'(mm)	C(mm)	D(mm)	E(mm)	F(mm)
HPC6045NF	6.0±0.3	6.0±0.3	4.8±0.2	4.2±0.3	1.7±0.3	4.5±0.3	4.25±0.3

L(mm)	G(mm)	G1(mm)	H(mm)
6.5	4.25	1.80min	4.8

3. Part Numbering



- A: Series
 - B: Dimension
 - C: Type
 - D: Inductance
 - E: Inductance Tolerance
- A/B*C
- 2R2=2.20uh 100=10uh,101=100uh,102=1000uh
 M=±20%,Y=±30%.
 marking direction cannot decide polarity. Color: Black, unidirectional.
 magnetic shielding

4. Specification

Part Number	Inductance L0 (uH) @ 0 A	Tolerance				Rated current				DCR (mΩ) @25°C ±20%.
						Temperature current I rms (A)		Saturation current I sat (A)		
		K	L	M	Y	Typ	Max	Typ	Max	
HPC6045NF-R36	0.36	/	/	±20%	±30%	9.00	8.50	18.00	16.50	4.80
HPC6045NF-R47	0.47	/	/	±20%	±30%	8.60	8.00	17.00	16.00	6.80
HPC6045NF-R82	0.82	/	/	±20%	±30%	8.20	7.50	14.50	13.50	8.50
HPC6045NF-1R0	1.00	/	/	±20%	±30%	8.00	7.30	13.50	12.50	10.0
HPC6045NF-1R2	1.20	/	/	±20%	±30%	7.50	7.00	12.50	11.50	10.5
HPC6045NF-1R3	1.30	/	/	±20%	±30%	7.50	7.00	12.50	11.50	10.5
HPC6045NF-1R5	1.50	/	/	±20%	±30%	7.00	6.60	12.00	11.00	11.7
HPC6045NF-1R8	1.80	/	/	±20%	±30%	6.80	6.20	11.00	10.00	12.0
HPC6045NF-2R0	2.00	/	/	±20%	±30%	6.50	5.80	10.50	9.50	13.5
HPC6045NF-2R2	2.20	/	/	±20%	±30%	6.00	5.30	9.50	8.55	15.0
HPC6045NF-2R3	2.30	/	/	±20%	±30%	5.80	5.00	9.30	8.20	16.0
HPC6045NF-3R0	3.00	/	/	±20%	±30%	5.20	4.60	8.00	7.50	20.0
HPC6045NF-3R3	3.30	/	/	±20%	±30%	5.00	4.50	7.80	7.30	21.0
HPC6045NF-3R6	3.60	/	/	±20%	±30%	4.90	4.30	7.40	6.90	22.5
HPC6045NF-4R7	4.70	/	±15%	±20%	±30%	4.50	4.00	6.80	6.20	26.0
HPC6045NF-5R6	5.60	/	±15%	±20%	±30%	4.10	3.70	6.40	5.70	31.0
HPC6045NF-6R3	6.30	/	±15%	±20%	±30%	3.80	3.50	5.90	5.30	33.0
HPC6045NF-6R8	6.80	/	±15%	±20%	±30%	3.60	3.30	5.70	5.15	34.0
HPC6045NF-8R2	8.20	/	±15%	±20%	±30%	3.40	2.90	5.10	4.50	46.0
HPC6045NF-100	10.0	±10%	±15%	±20%	±30%	3.20	2.60	4.60	4.20	52.0
HPC6045NF-150	15.0	±10%	±15%	±20%	±30%	2.80	2.20	3.80	3.30	71.0
HPC6045NF-180	18.0	±10%	±15%	±20%	±30%	2.60	2.10	3.40	2.90	80.0
HPC6045NF-220	22.0	±10%	±15%	±20%	±30%	2.30	1.90	3.30	2.70	96.0
HPC6045NF-330	33.0	±10%	±15%	±20%	±30%	1.80	1.50	2.50	2.10	145
HPC6045NF-470	47.0	±10%	±15%	±20%	±30%	1.60	1.20	2.00	1.75	200
HPC6045NF-560	56.0	±10%	±15%	±20%	±30%	1.40	1.00	1.80	1.65	230
HPC6045NF-680	68.0	±10%	±15%	±20%	±30%	1.10	0.92	1.60	1.52	305
HPC6045NF-820	82.0	±10%	±15%	±20%	±30%	0.98	0.88	1.50	1.40	365
HPC6045NF-101	100	±10%	±15%	±20%	±30%	0.92	0.82	1.33	1.25	456
HPC6045NF-121	120	±10%	±15%	±20%	±30%	0.85	0.79	1.20	1.10	500
HPC6045NF-151	150	±10%	±15%	±20%	±30%	0.75	0.70	1.10	1.00	626
HPC6045NF-181	180	±10%	±15%	±20%	±30%	0.68	0.60	1.00	0.90	745
HPC6045NF-221	220	±10%	±15%	±20%	±30%	0.60	0.50	0.88	0.77	900
HPC6045NF-331	330	±10%	±15%	±20%	±30%	0.55	0.45	0.60	0.55	1400
HPC6045NF-471	470	±10%	±15%	±20%	±30%	0.40	0.35	0.50	0.45	2050

Note:

1. All test data referenced to 25°C ambient , Ls/Q:1MHz/1V.
2. Testing Instrument : HP4284A,CH11025,CH3302,CH1320 ,CH1320S LCR METER / Rdc:CH502BC MICRO OHMMETER.
3. Heat Rated Current (I rms) will cause the coil temperature rise approximately Δ t of 40°C (keep 1min.).
4. Saturation Current (Isat) will cause L0 to drop 30% typical. (keep quickly).
5. The part temperature (ambient + temp rise) should not exceed 125°C under worst case operating conditions.Circuit design,component,PCB trace size and thickness,airflow and other cooling provisions all affect the part temperature. Part temperature should be verified in the end application.
6. Special inquiries besides the above common used types can be met on your requirement.

5. Material List

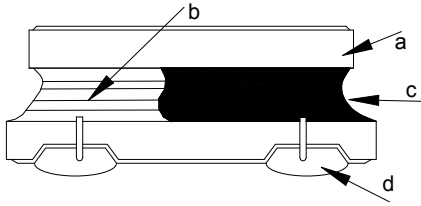

NO	Items	Materials
a	Core	Ferrite Core
b	Wire	Copper Wire
c	Coating	Epoxy with magnetic
d	Solder	Lead free

6. Reliability and Test Condition

Item	Performance	Test Condition															
Operating temperature	-40~+125°C (Including self - temperature rise)																
Storage temperature	-40~+125°C (on board)																
Electrical Performance Test																	
Inductance	Refer to standard electrical characteristics list.	HP4284A, CH11025, CH3302, CH1320, CH1320S LCR Meter.															
DCR		CH502BC, Agilent33420A Micro-Ohm Meter.															
Saturation Current (Isat)	ΔL30% typical.	Saturation DC Current (Isat) will cause L0 to drop ΔL(%) (keep quickly).															
Heat Rated Current (Irms)	Approximately ΔT ≤ 40°C	Heat Rated Current (Irms) will cause the coil temperature rise ΔT(°C) without core loss. 1. Applied the allowed DC current (keep 1 min.). 2. Temperature measured by digital surface thermometer															
Reliability Test																	
Life Test	Appearance : No damage. Inductance : within ±10% of initial value Q : Shall not exceed the specification value. RDC : within ±15% of initial value and shall not exceed the specification value	Preconditioning: Run through IR reflow for 2 times. (IPC/JEDEC J-STD-020D Classification Reflow Profiles) Temperature : 125±2°C (Bead) Temperature : 85±2°C (Inductor) Applied current : rated current Duration : 1000±12hrs Measured at room temperature after placing for 24±2 hrs															
Load Humidity		Preconditioning: Run through IR reflow for 2 times. (IPC/JEDEC J-STD-020D Classification Reflow Profiles) Humidity : 85±2% R.H. Temperature : 85°C±2°C Duration : 1000hrs Min. with 100% rated current Measured at room temperature after placing for 24±2 hrs															
Thermal shock		Preconditioning: Run through IR reflow for 2 times. (IPC/JEDEC J-STD-020D Classification Reflow Profiles) Condition for 1 cycle Step1 : -40±2°C 30±5min Step2 : 25±2°C ≤ 0.5min Step3 : 105±2°C 30±5min Number of cycles : 500 Measured at room temperature after placing for 24±2 hrs															
Vibration		Oscillation Frequency: 10~2K~10Hz for 20 minutes Equipment : Vibration checker Total Amplitude: 1.52mm±10% Testing Time : 12 hours (20 minutes, 12 cycles each of 3 orientations) °															
Shock																	
Bending																	
<table border="1"> <thead> <tr> <th>Type</th> <th>Peak value (g's)</th> <th>Normal duration (D) (ms)</th> <th>Wave form</th> <th>Velocity change (V)/t/sec</th> </tr> </thead> <tbody> <tr> <td>SMD</td> <td>>=0.8</td> <td>5.40x100±2min</td> <td>Half sine</td> <td>15.4</td> </tr> <tr> <td>Through hole</td> <td>>=0.8</td> <td>0.5.1.2.6m</td> <td>Half-sine</td> <td>12.3</td> </tr> </tbody> </table> <p>Shall be mounted on a FR4 substrate of the following dimensions: >=0.8x1.2x1.6mm <0.8x1.2x1.6mm Bend depth = 0.8mm Bend radius = 0.8mm duration of 10 sec.</p>			Type	Peak value (g's)	Normal duration (D) (ms)	Wave form	Velocity change (V)/t/sec	SMD	>=0.8	5.40x100±2min	Half sine	15.4	Through hole	>=0.8	0.5.1.2.6m	Half-sine	12.3
Type	Peak value (g's)	Normal duration (D) (ms)	Wave form	Velocity change (V)/t/sec													
SMD	>=0.8	5.40x100±2min	Half sine	15.4													
Through hole	>=0.8	0.5.1.2.6m	Half-sine	12.3													
Solderability																	
Soderability	More than 95% of the terminal electrode should be covered with solder °	Preheat: 150°C, 60sec. ° Solder: Sn99.5%-Cu0.5% ° Temperature: 245±5°C ° Flux for lead free: Rosin. 9.5% ° Dip time: 4±1sec °															

Item	Performance	Test Method and Remarks
Soderability	More than 95% of the terminal electrode should be covered with solder °	Preheat: 150°C, 60sec. ° Solder: Sn99.5%-Cu0.5% ° Temperature: 245±5°C ° Flux for lead free: Rosin. 9.5% ° Dip time: 4±1sec °

		Depth: completely cover the termination						
Resistance to Soldering Heat		Number of heat cycles: 1						
		<table border="1"> <tr> <th>Temperature (°C)</th> <th>Time(s)</th> <th>Temperature ramp/immersion and emersion rate</th> </tr> <tr> <td>260 ±5(solder temp)</td> <td>10 ±1</td> <td>25mm/s ±6 mm/s</td> </tr> </table>	Temperature (°C)	Time(s)	Temperature ramp/immersion and emersion rate	260 ±5(solder temp)	10 ±1	25mm/s ±6 mm/s
Temperature (°C)	Time(s)	Temperature ramp/immersion and emersion rate						
260 ±5(solder temp)	10 ±1	25mm/s ±6 mm/s						
Terminal Strength	<p>Appearance : No damage. Inductance : within±10% of initial value Q : Shall not exceed the specification value. RDC : within ±15% of initial value and shall not exceed the specification value</p>	<p>Preconditioning: Run through IR reflow for 2 times.(IPC/JEDEC J-STD-020Dclassification Reflow Profiles With the component mounted on a PCB with the device to be tested, apply a force (>0.805:1kg , <=0.805:0.5kg)to the side of a device being tested. This force shall be applied for 60 +1 seconds. Also the force shall be applied gradually as not to apply a shock to the component being tested.</p>						

7. Soldering and Mounting

(1) Soldering

Mildly activated rosin fluxes are preferred. The minimum amount of solder can lead to damage from the stresses caused by the difference in coefficients of expansion between solder, chip and substrate. TAI-TECH terminations are suitable for re-flow soldering systems. If hand soldering cannot be avoided, the preferred technique is the utilization of hot air soldering tools.

(2) Solder re-flow:

Recommended temperature profiles for re-flow soldering in Figure 1.

(3) Soldering Iron:

Products attachment with a soldering iron is discouraged due to the inherent process control limitations. In the event that a soldering iron must be employed the following precautions are recommended.

- Preheat circuit and products to 150°C
- Never contact the ceramic with the iron tip
- Use a 20 watt soldering iron with tip diameter of 1.0mm
- 355°C tip temperature (max)
- 1.0mm tip diameter (max)
- Limit soldering time to 4~5sec.

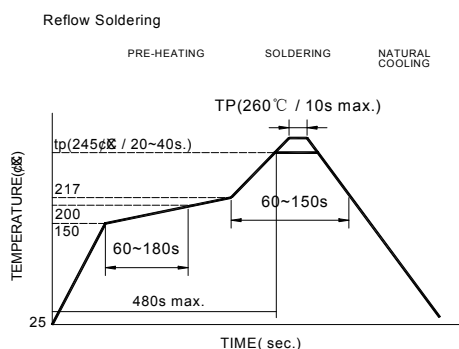

Fig.1

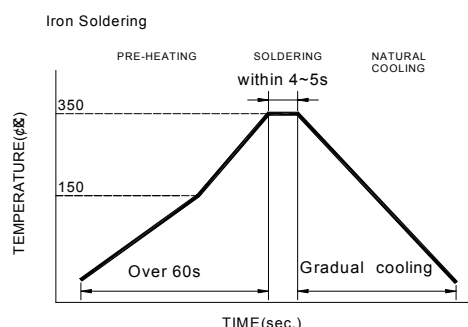
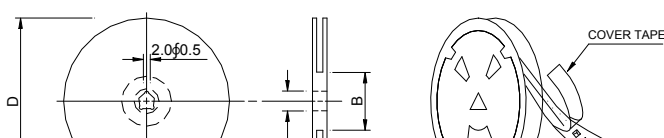

Fig.2

8. Packaging Information

(1) Reel Dimension



Type	A(mm)	B(mm)	C(mm)	D(mm)
13"x16mm	16.5±0.5	80±2.0	13.5±0.5	330±3.0

(2) Tape Dimension

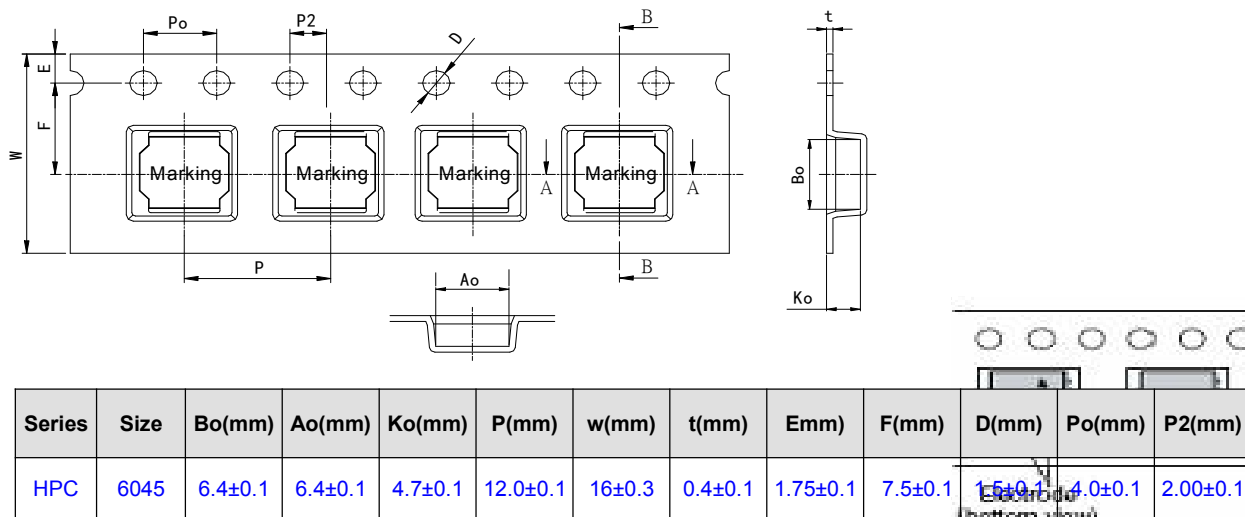

(3) Packaging Quantity

HPC	6045
Reel	1000
Inner box	2000
Carton	8000

(4) Tearing Off Force

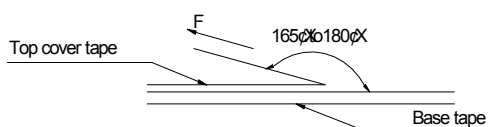

The force for tearing off cover tape is 10 to 130 grams in the arrow direction under the following conditions(referenced ANSI/EIA-481-C-2003 of 4.11 stadnard).

Room Temp. (°C)	Room Humidity (%)	Room atm (hPa)	Tearing Speed mm/min
5~35	45~85	860~1060	300

Application Notice

- Storage Conditions (component level)
To maintain the solderability of terminal electrodes:
 1. TAI-TECH products meet IPC/JEDEC J-STD-020D standard-MSL, level 1.
 2. Temperature and humidity conditions: Less than 40°C and 60% RH.
 3. Recommended products should be used within 12 months form the time of delivery.
 4. The packaging material should be kept where no chlorine or sulfur exists in the air.
- Transportation
 1. Products should be handled with care to avoid damage or contamination from perspiration and skin oils.
 2. The use of tweezers or vacuum pick up is strongly recommended for individual components.
 3. Bulk handling should ensure that abrasion and mechanical shock are minimized.

9. Typical Performance Curves

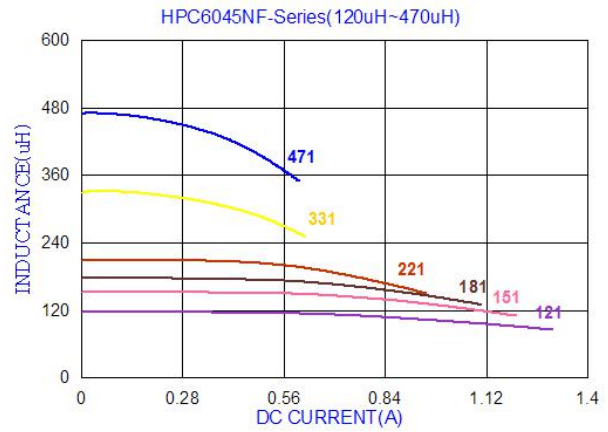
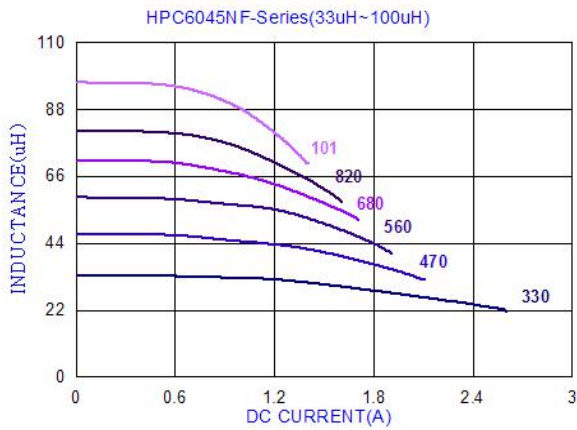
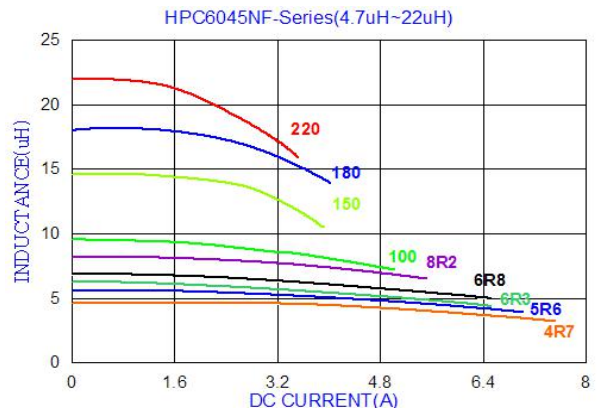
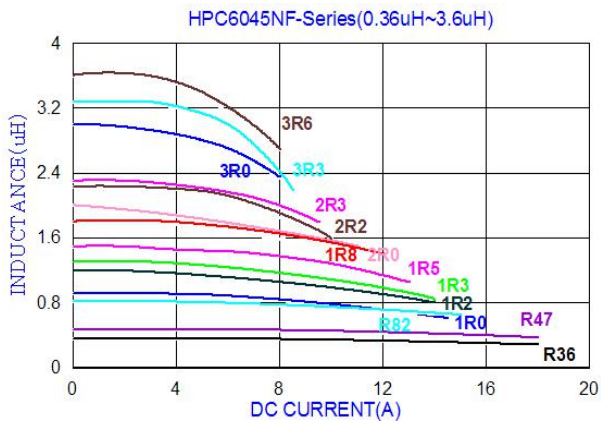
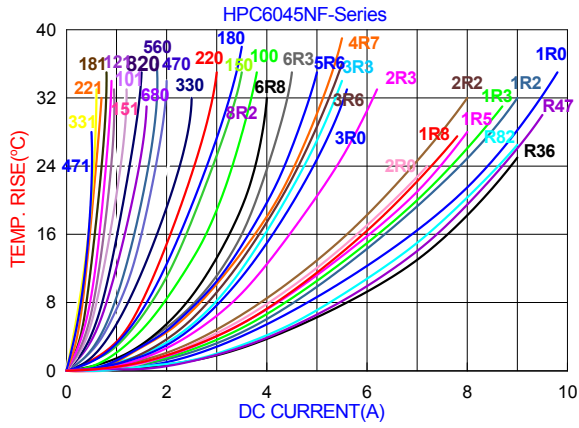

Core chipping

The appearance standard of the chipping size on top side, and bottom side ferrite core is listed below.

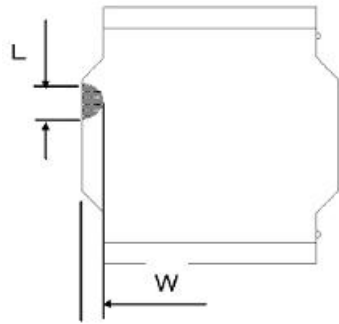

L	W
1.5mm Max.	1.5mm Max.

Void appearance tolerance Limit

Size of voids occurring to coating resin is specified below.

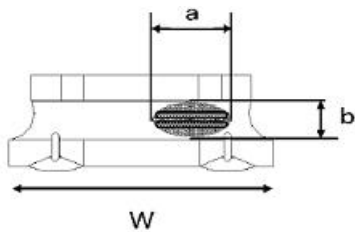

Exposed wire tolerance limit of coating resin part on product side.

Size of exposed wire occurring to coating resin is specified below.

1. Width direction (dimension a) : Acceptable when $a \leq w/2$.
2. Length direction (dimension b) : Dimension b is not specified.
3. The total area of exposed wire occurring to each sides is not greater than 50% of coating resin area, and is acceptable.

External appearance criterion for exposed wire

Exposed end of the winding wire at the secondary side should be 3mm and below.

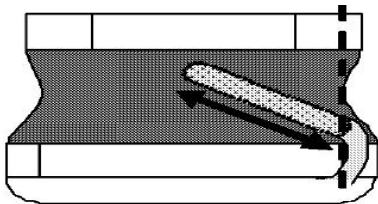

Electrode appearance criterion for exposed wire

Visual check on core surface with no crack means pass.

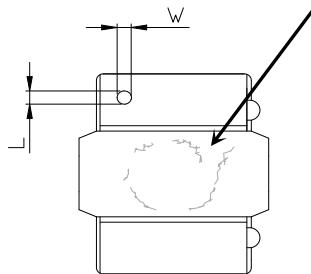

Only top side of wire is exposed.
(regardless of whole top side of wire exposed)

Conforming



Wire is soldered insufficiently and less than half of outer diameter is covered with solder.

Less than 1/2 of joint side length.
(More than 1/2 is selected as defect)

L	W
1.5mm Max.	1.5mm Max.

Electrodes with foreign body (dirt) appearance standards
Foreign materials (dirt) will not affect the coplanarity of PAD,
below the example of foreign materials (dirt) quantity ≤ 2 PCS on single PAD.
dimension range as below.