



# Power Inductor

**HPC4012TF-SERIES**

## 1. Features

1. This specification applies Low Profile Power Inductors.
2. 100% Lead(Pb) & Halogen-Free and RoHS compliant.



## 2. Dimension

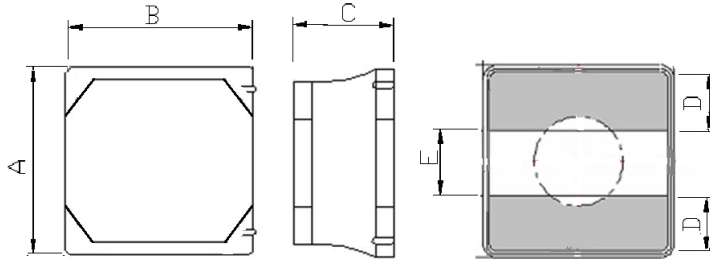

| Series    | A(mm)   | B(mm)   | C(mm)    | D(mm)    | E(mm)    |
|-----------|---------|---------|----------|----------|----------|
| HPC4012TF | 4.0±0.2 | 4.0±0.2 | 1.2 max. | 1.2 ref. | 1.6 ref. |

Units: mm

## 3. Part Numbering

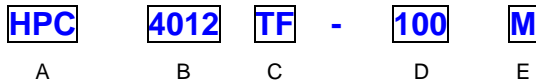

- A: Series  
 B: Dimension  
 C: Lead Free  
 D: Inductance                      100=10uH  
 E: Inductance Tolerance        M=±20% ; Y=±30%

## 4. Specification

| TAI-TECH Part Number | Inductance (uH) | Tolerance (%) | Test Frequency (Hz) | SRF (MHz) typ. | DCR (Ω) ±20% | I sat (A)typ. | I sat (A)Max. | I rms (A)typ. | I rms (A)Max. |
|----------------------|-----------------|---------------|---------------------|----------------|--------------|---------------|---------------|---------------|---------------|
| HPC4012TF -1R0Y      | 1.0             | ±30%          | 1V100K              | 100            | 0.042        | 3.30          | 2.80          | 2.50          | 2.20          |
| HPC4012TF -2R2M      | 2.2             | ±20%          | 1V100K              | 70             | 0.060        | 1.95          | 1.65          | 2.20          | 1.90          |
| HPC4012TF -3R3M      | 3.3             | ±20%          | 1V100K              | 60             | 0.070        | 1.60          | 1.40          | 1.90          | 1.70          |
| HPC4012TF -4R7M      | 4.7             | ±20%          | 1V100K              | 45             | 0.095        | 1.40          | 1.20          | 1.70          | 1.50          |
| HPC4012TF -6R8M      | 6.8             | ±20%          | 1V100K              | 35             | 0.125        | 1.10          | 0.90          | 1.50          | 1.30          |
| HPC4012TF -100M      | 10              | ±20%          | 1V100K              | 30             | 0.180        | 1.00          | 0.80          | 1.30          | 1.10          |
| HPC4012TF -150M      | 15              | ±20%          | 1V100K              | 24             | 0.260        | 0.80          | 0.65          | 0.95          | 0.75          |
| HPC4012TF -220M      | 22              | ±20%          | 1V100K              | 18             | 0.400        | 0.60          | 0.50          | 0.72          | 0.62          |

Note:

 Isat : Based on inductance change ( $\Delta L/L0 : \leq 30\%$ ) @ ambient temp. 25°C

 I rms : Based on temperature rise ( $\Delta T : 40^\circ\text{C}$  typ.) max

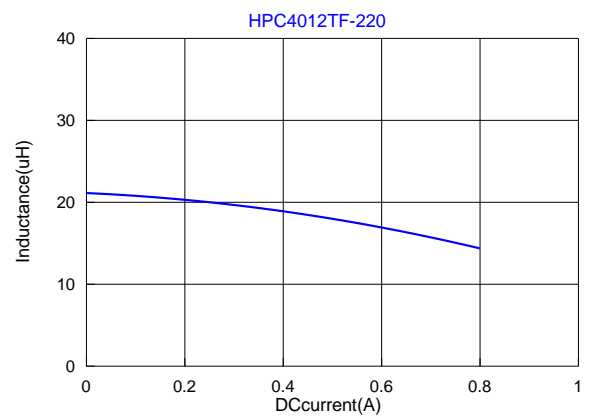
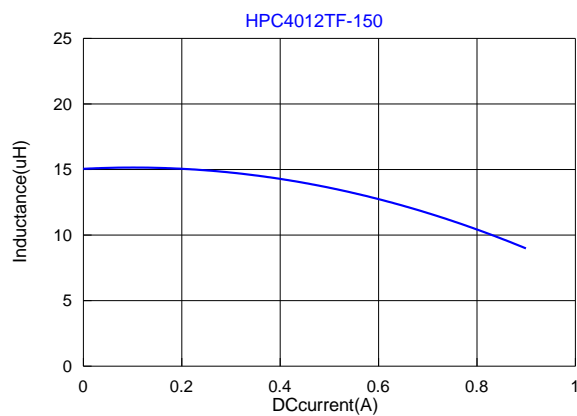
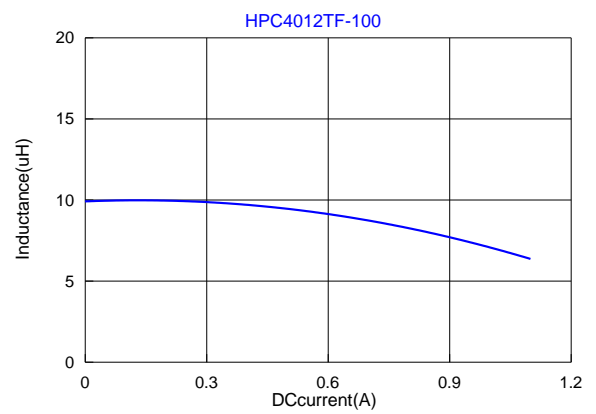
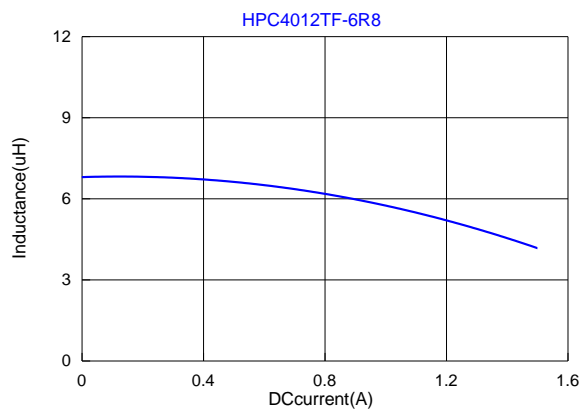
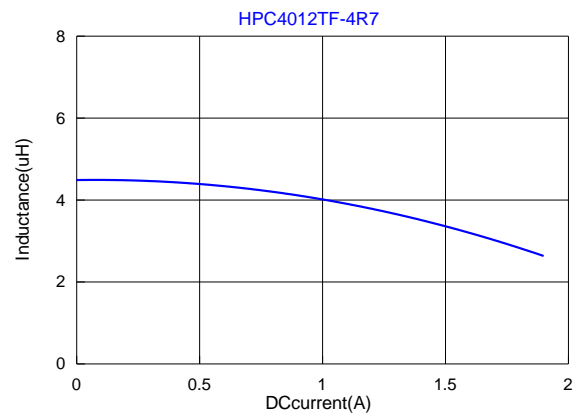
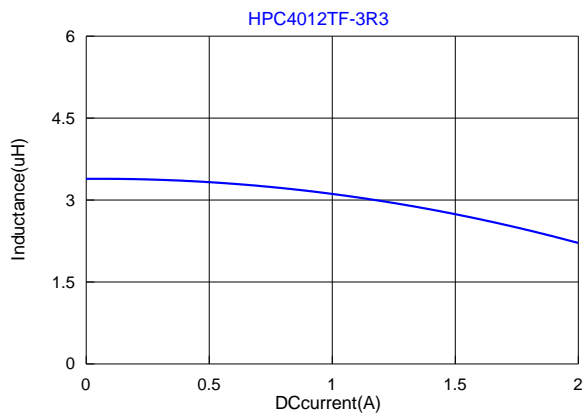
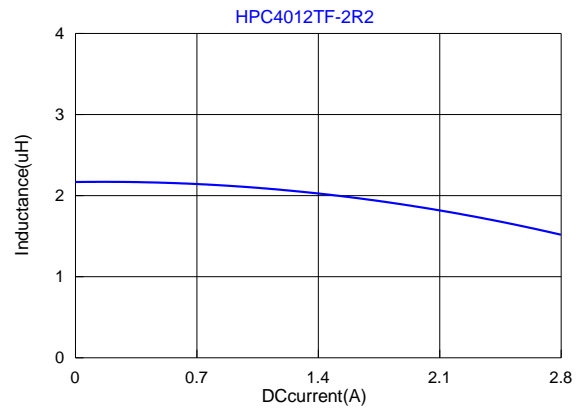
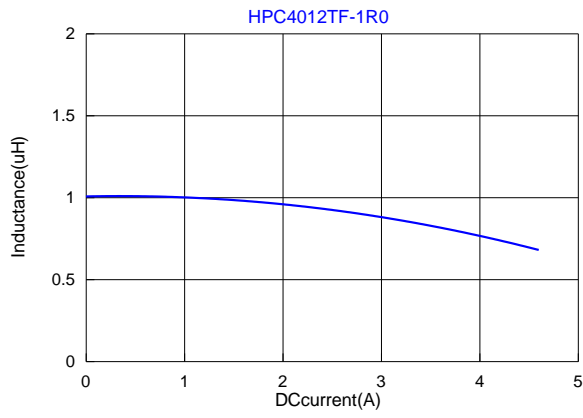

Void appearance tolerance Limit

Size of voids occurring to coating resin is specified below.

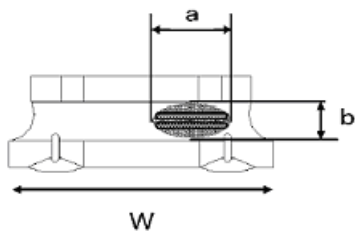

Appearance of exposed wire tolerance limit :

1. Width direction ( dimension a ) : Acceptable when  $a \leq w/2$   
Nonconforming when  $a > w/2$
2. Length direction ( dimension b ) : Dimension b is not specified.
3. The total area of exposed wire occurring to each sides is not greater than 50% of coating resin area, and is acceptable.

External appearance criterion for exposed wire

Exposed end of the winding wire at the secondary side should be 2mm and below.

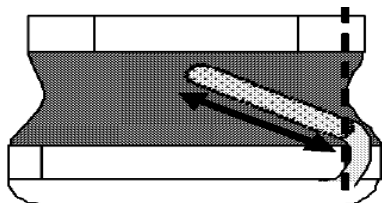

5. Material

| No. | Description | Specification                      |
|-----|-------------|------------------------------------|
| a.  | Core        | Ferrite Core                       |
| b.  | Wire        | Enameled Copper Wire               |
| c.  | Glue        | Epoxy / Epoxy with magnetic powder |
| d.  | Terminal    | Ag/Ni/Sn                           |

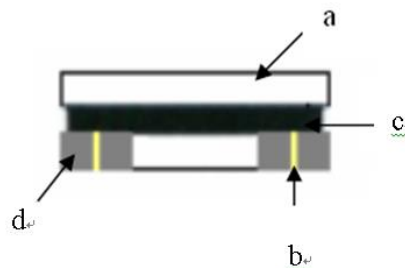

## 6. Reliability and Test Condition

| Item                               | Performance  | Test Condition  |
|------------------------------------|--|---|
| Operating temperature              | -40~+125℃ (Including self - temperature rise)  |   |
| Storage temperature                | -40~+125℃ (on board)   |   |
| <b>Electrical Performance Test</b> |  |   |
| Inductance                         | Refer to standard electrical characteristics list.   | HP4284A,CH11025,CH3302,CH1320,CH1320S<br>LCR Meter.   |
| DCR                                |  | CH16502,Agilent33420A Micro-Ohm Meter.  |
| Saturation Current (Isat)          | $\Delta L \leq 30\%$ typical.  | Saturation DC Current (Isat) will cause L0 to drop $\Delta L(\%)$ (keep quickly).   |
| Heat Rated Current (Irms)          | Approximately $\Delta T \leq 40^\circ\text{C}$   | Heat Rated Current (Irms) will cause the coil temperature rise $\Delta T(^\circ\text{C})$ without core loss.<br>1.Applied the allowed DC current(keep 1 min.).<br>2.Temperature measured by digital surface thermometer   |
| <b>Reliability Test</b>            |  |   |
| Life Test                          | Appearance : No damage.<br>Inductance : within $\pm 10\%$ of initial value<br>Q : Shall not exceed the specification value.<br>RDC : within $\pm 15\%$ of initial value and shall not exceed the specification value | Preconditioning: Run through IR reflow for 2 times.( IPC/JEDEC J-STD-020DCClassification Reflow Profiles)<br>Temperature : $125 \pm 2^\circ\text{C}$ (Inductor)<br>Applied current : rated current<br>Duration : $1000 \pm 12$ hrs<br>Measured at room temperature after placing for $24 \pm 2$ hrs   |
| Load Humidity                      |  | Preconditioning: Run through IR reflow for 2 times.( IPC/JEDEC J-STD-020DCClassification Reflow Profiles)<br>Humidity : $85 \pm 2\%$ R.H.<br>Temperature : $85 \pm 2^\circ\text{C}$<br>Duration : 1000hrs Min. with 100% rated current<br>Measured at room temperature after placing for $24 \pm 2$ hrs   |
| Moisture Resistance                |  | Preconditioning: Run through IR reflow for 2 times.( IPC/JEDEC J-STD-020DCClassification Reflow Profiles)<br>1. Baked at $50^\circ\text{C}$ for 25hrs, measured at room temperature after placing for 4 hrs.<br>2. Raise temperature to $65 \pm 2^\circ\text{C}$ 90-100%RH in 2.5hrs, and keep 3 hours, cool down to $25^\circ\text{C}$ in 2.5hrs.<br>3. Raise temperature to $65 \pm 2^\circ\text{C}$ 90-100%RH in 2.5hrs, and keep 3 hours, cool down to $25^\circ\text{C}$ in 2.5hrs,keep at $25^\circ\text{C}$ for 2 hrs then keep at $-10^\circ\text{C}$ for 3 hrs<br>4. Keep at $25^\circ\text{C}$ 80-100%RH for 15min and vibrate at the frequency of 10 to 55 Hz to 10 Hz, measure at room temperature after placing for 1~2 hrs. |
| Thermal shock                      |  | Preconditioning: Run through IR reflow for 2 times.( IPC/JEDEC J-STD-020DCClassification Reflow Profiles)<br>Condition for 1 cycle<br>Step1 : $-40 \pm 2^\circ\text{C}$ 30 $\pm$ 5min<br>Step2 : $25 \pm 2^\circ\text{C}$ $\leq$ 0.5min<br>Step3 : $125 \pm 2^\circ\text{C}$ 30 $\pm$ 5min<br>Number of cycles : 500<br>Measured at room temperature after placing for $24 \pm 2$ hrs   |
| Vibration                          |  | Oscillation Frequency: 10~2K~10Hz for 20 minutes<br>Equipment : Vibration checker<br>Total Amplitude:1.52mm $\pm$ 10%<br>Testing Time : 12 hours(20 minutes, 12 cycles each of 3 orientations) *  |

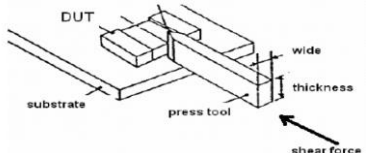
| Item                         | Performance   | Test Condition   |                  |                            |  |                     |                            |                |    |    |           |      |      |    |    |           |      |
|------------------------------|---|--|------------------|----------------------------|--|---------------------|----------------------------|----------------|----|----|-----------|------|------|----|----|-----------|------|
| Shock                        | Appearance : No damage.<br>Inductance : within±10% of initial value<br>Q : Shall not exceed the specification value.  | <table border="1" data-bbox="991 230 1409 353"> <thead> <tr> <th>Type</th> <th>Peak value (g' s)</th> <th>Normal duration (D) (ms)</th> <th>Wave form</th> <th>Velocity change (V)/ft/sec</th> </tr> </thead> <tbody> <tr> <td>SMD</td> <td>50</td> <td>11</td> <td>Half-sine</td> <td>11.3</td> </tr> <tr> <td>Lead</td> <td>50</td> <td>11</td> <td>Half-sine</td> <td>11.3</td> </tr> </tbody> </table> shocks in each direction along 3 perpendicular axes.  | Type             | Peak value (g' s)          | Normal duration (D) (ms)                     | Wave form           | Velocity change (V)/ft/sec | SMD            | 50 | 11 | Half-sine | 11.3 | Lead | 50 | 11 | Half-sine | 11.3 |
| Type                         | Peak value (g' s)   | Normal duration (D) (ms)   | Wave form        | Velocity change (V)/ft/sec |  |                     |                            |                |    |    |           |      |      |    |    |           |      |
| SMD                          | 50  | 11   | Half-sine        | 11.3                       |  |                     |                            |                |    |    |           |      |      |    |    |           |      |
| Lead                         | 50  | 11   | Half-sine        | 11.3                       |  |                     |                            |                |    |    |           |      |      |    |    |           |      |
| Bending                      | RDC : within ±15% of initial value and shall not exceed the specification value   | Shall be mounted on a FR4 substrate of the following dimensions: >=0805:40x100x1.2mm<br><0805:40x100x0.8mm<br>Bending depth:<br>>=0805inch(2012mm):1.2mm<br><0805 inch(2012mm):0.8mm<br>duration of 10 sec.  |                  |                            |  |                     |                            |                |    |    |           |      |      |    |    |           |      |
| Soderability                 | More than 95% of the terminal electrode should be covered with solder °   | Preheat: 150°C ,60sec. °<br>Solder: Sn96.5% Ag3% Cu0.5%<br>Temperature: 245±5°C °<br>Flux for lead free: Rosin. 9.5% °<br>Dip time: 4±1sec °<br>Depth: completely cover the termination  |                  |                            |  |                     |                            |                |    |    |           |      |      |    |    |           |      |
| Resistance to Soldering Heat | Appearance : No damage.<br>Inductance : within±10% of initial value<br>Q : Shall not exceed the specification value.<br>RDC : within ±15% of initial value and shall not exceed the specification value | Number of heat cycles: 1<br><table border="1" data-bbox="991 748 1370 882"> <thead> <tr> <th>Temperature (°C)</th> <th>Time(s)</th> <th>Temperature ramp/immersion and emersion rate</th> </tr> </thead> <tbody> <tr> <td>260 ±5(solder temp)</td> <td>10 ±1</td> <td>25mm/s ±6 mm/s</td> </tr> </tbody> </table>  | Temperature (°C) | Time(s)                    | Temperature ramp/immersion and emersion rate | 260 ±5(solder temp) | 10 ±1                      | 25mm/s ±6 mm/s |    |    |           |      |      |    |    |           |      |
| Temperature (°C)             | Time(s)   | Temperature ramp/immersion and emersion rate   |                  |                            |  |                     |                            |                |    |    |           |      |      |    |    |           |      |
| 260 ±5(solder temp)          | 10 ±1   | 25mm/s ±6 mm/s   |                  |                            |  |                     |                            |                |    |    |           |      |      |    |    |           |      |
| Terminal Strength            |   | Preconditioning:Run through IR reflow for 2 times.( IPC/JEDEC J-STD-020DClassification Reflow Profiles<br>With the component mounted on a PCB with the device to be tested, apply a force (>0805 inch(2012mm):1kg , <=0805 inch(2012mm):0.5kg)to the side of a device being tested.<br>This force shall be applied for 60 +1 seconds. Also the force shall be applied gradually as not to apply a shock to the component being tested.  |                  |                            |  |                     |                            |                |    |    |           |      |      |    |    |           |      |

## 7. Soldering and Mounting

### 7-1. Soldering

Mildly activated rosin fluxes are preferred. TAI-TECH terminations are suitable for all wave and re-flow soldering systems. If hand soldering cannot be avoided, the preferred technique is the utilization of hot air soldering tools.

#### 7-1.1 Solder re-flow:

Recommended temperature profiles for re-flow soldering in Figure 1.

#### 7-1.2 Soldering Iron(Figure 2):

Products attachment with a soldering iron is discouraged due to the inherent process control limitations. In the event that a soldering iron must be employed the following precautions are recommended.

- Preheat circuit and products to 150°C
- Never contact the ceramic with the iron tip
- Use a 20 watt soldering iron with tip diameter of 1.0mm
- 355°C tip temperature (max)
- 1.0mm tip diameter (max)
- Limit soldering time to 4-5 sec.

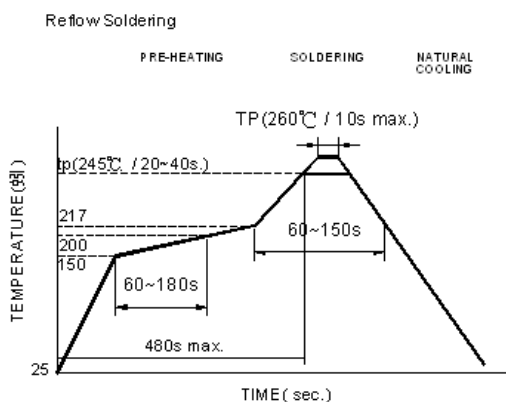

Reflow times: 3 times max.

Fig.1

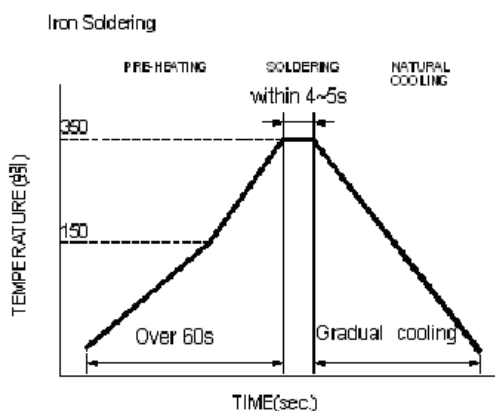

Iron Soldering times: 1 times max.

Fig.2

### 7-2. Recommended PC Board Pattern

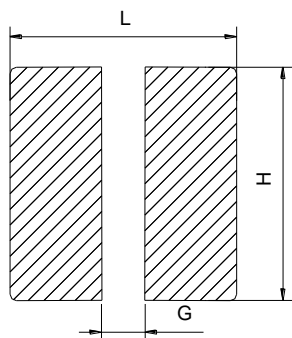

| L(mm) | G(mm) | H(mm) |
|-------|-------|-------|
| 4.2   | 1.2   | 4.2   |

## 8. Packaging Information

### 8-1. Reel Dimension

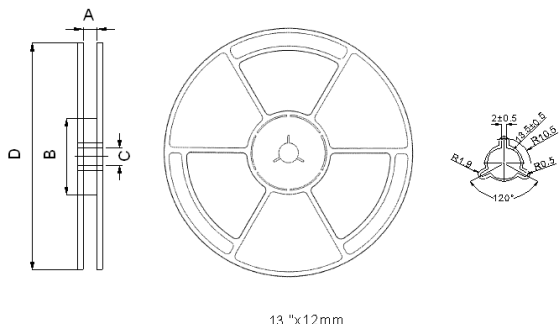

| Type     | A(mm)  | B(mm)   | C(mm)    | D(mm)   |
|----------|--------|---------|----------|---------|
| 13"x12mm | 12±1.5 | 100±0.5 | 13.2±0.5 | 330±0.5 |

### 8-2. Tape Dimension / 12mm

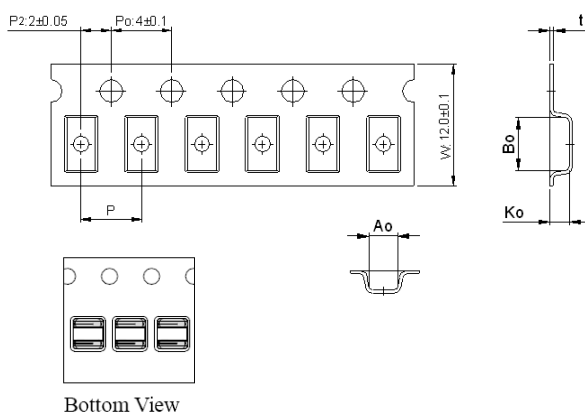

| Series | Size | Bo(mm)   | Ao(mm)   | Ko(mm)   | P(mm)    | t(mm)     |
|--------|------|----------|----------|----------|----------|-----------|
| HPC    | 4012 | 4.35±0.1 | 4.50±0.1 | 1.55±0.1 | 8.0±0.10 | 0.25±0.05 |

### 8-3. Packaging Quantity

|             |      |
|-------------|------|
| Chip size   | 4012 |
| Chip / Reel | 4500 |

### 8-4. Tearing Off Force

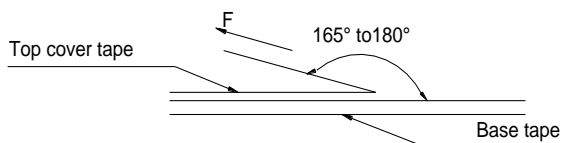

The force for tearing off cover tape is 15 to 80 grams in the arrow direction under the following conditions.

| Room Temp. (°C) | Room Humidity (%) | Room atm (hPa) | Tearing Speed mm/min |
|-----------------|-------------------|----------------|----------------------|
| 5-35            | 45-85             | 860-1060       | 300                  |

#### Application Notice

- Storage Conditions(component level)
  - To maintain the solderability of terminal electrodes:
    1. TAI-TECH products meet IPC/JEDEC J-STD-020D standard-MSL, level 1.
    2. Temperature and humidity conditions: Less than 40°C and 60% RH.
    3. Recommended products should be used within 12 months from the time of delivery.
    4. The packaging material should be kept where no chlorine or sulfur exists in the air.
- Transportation
  1. Products should be handled with care to avoid damage or contamination from perspiration and skin oils.
  2. The use of tweezers or vacuum pick up is strongly recommended for individual components.
  3. Bulk handling should ensure that abrasion and mechanical shock are minimized.