

Power Inductor	DFP252010NF-SERIES
-----------------------	---------------------------

ECN HISTORY LIST					
REV	DATE	DESCRIPTION	APPROVED	CHECKED	DRAWN
1.0	14/03/06	新 發 行	楊祥忠	詹偉特	林宜滙
備 註					

Power Inductor **DFP252010NF-SERIES**

1. Features

- 1. This specification applies Low Profile Power Inductors.
- 2. 100% Lead(Pb) & Halogen-Free and RoHS compliant.



2. Dimension

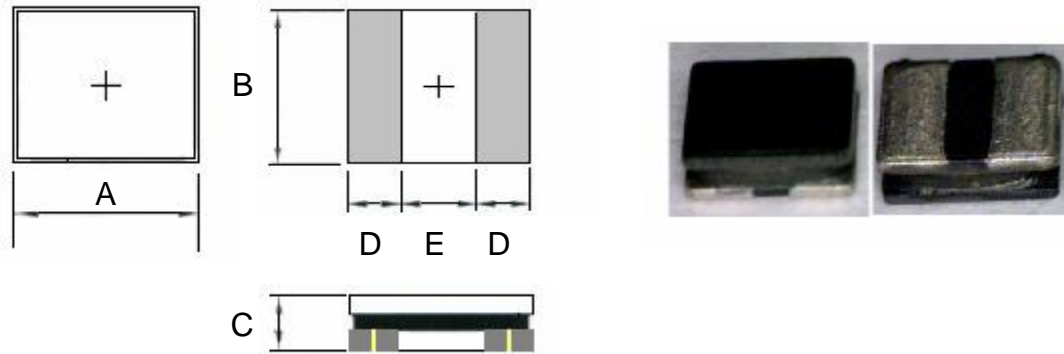

Series	A(mm)	B(mm)	C(mm)	D(mm)	E(mm)
DFP252010NF	2.5 -0.1/+0.2	2.0 -0.05/+0.35	1.0Max	0.85 ref.	0.80 ref.

Units: mm

3. Part Numbering

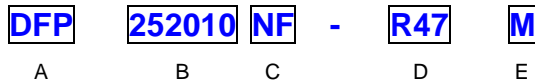

- A: Series
- B: Dimension
- C: Lead Free Material
- D: Inductance R47=0.47uH
- E: Inductance Tolerance M=±20%

4. Specification

TAI-TECH Part Number	Inductance (uH)	Tolerance (%)	Test Frequency (Hz)	DCR (Ω) typ.	DCR (Ω) Max.	I sat (A) typ.	I sat (A) Max.	I rms (A) typ	I rms (A) Max.
DFP252010NF-R24M	0.24	±20%	0.1V/1M	0.030	0.042	4.80	4.30	3.60	3.10
DFP252010NF-R47M	0.47	±20%	0.1V/1M	0.030	0.042	4.00	3.30	3.60	3.10
DFP252010NF-R68M	0.68	±20%	0.1V/1M	0.046	0.055	3.70	2.90	3.30	2.80
DFP252010NF-1R0M	1.0	±20%	0.1V/1M	0.060	0.080	3.40	2.70	2.60	2.2
DFP252010NF-1R5M	1.5	±20%	0.1V/1M	0.090	0.108	2.70	2.10	2.30	1.90
DFP252010NF-2R2M	2.2	±20%	0.1V/1M	0.130	0.169	2.40	1.90	1.80	1.50
DFP252010NF-4R7M	4.7	±20%	0.1V/1M	0.200	0.250	1.50	1.35	1.35	1.30

Note:

- I_{sat} : Based on inductance change (ΔL/L0 : ≤-30%) @ ambient temp. 25°C
- I_{rms} : Based on temperature rise (ΔT : 40°C.) Max

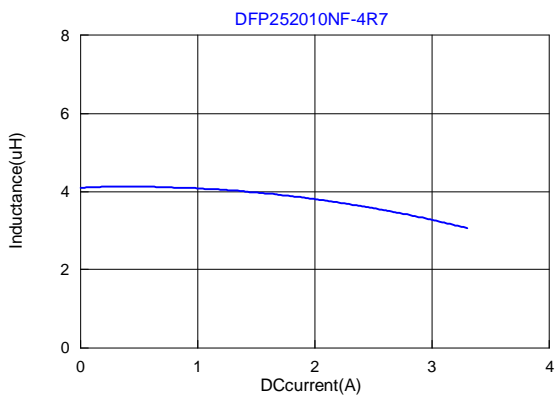
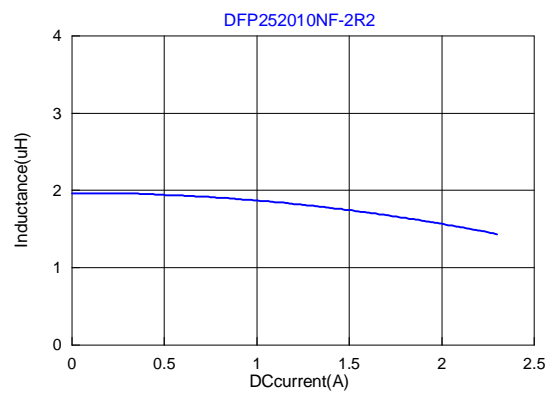
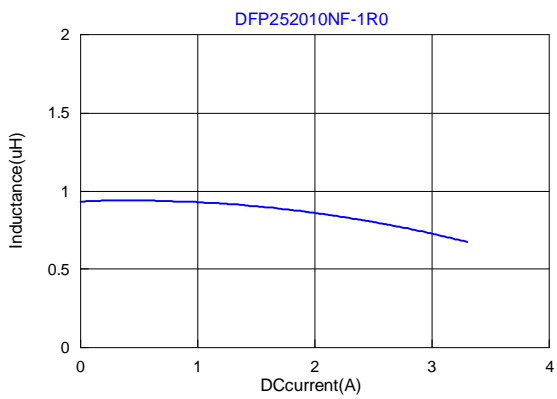
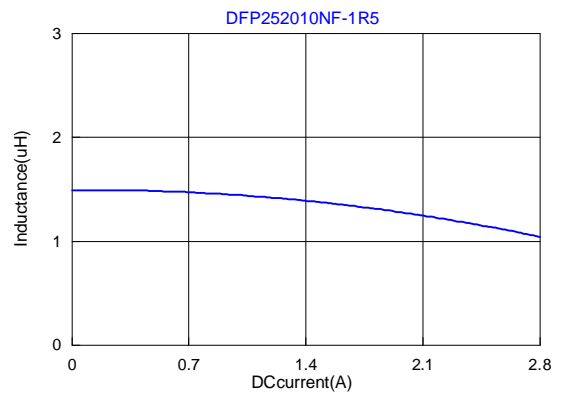
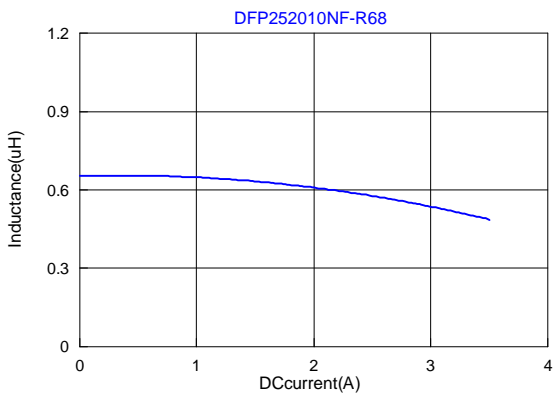
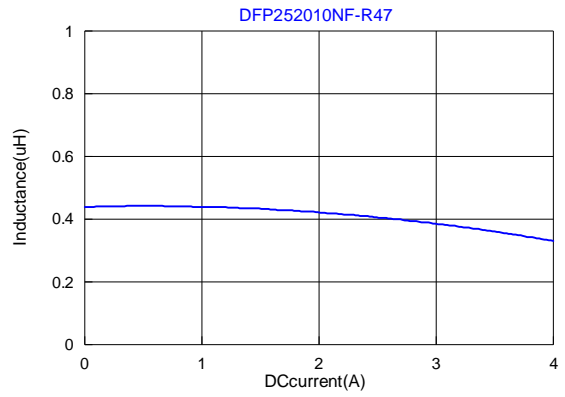
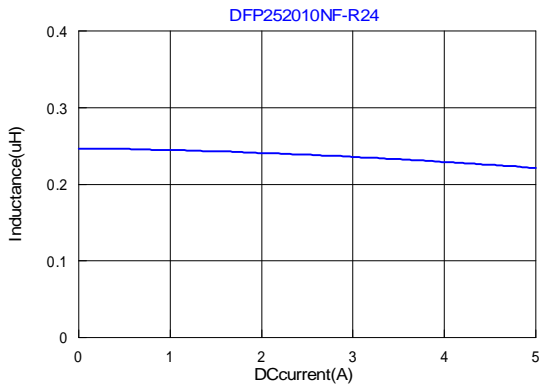

5. Material List

No.	Description	Specification
a.	Core	Ferrite Core
b.	Coating	Epoxy with magnetic powder
c.	Termination	Tin Pb Free
d.	Wire	Enameled Copper Wire

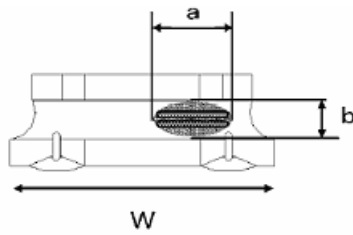
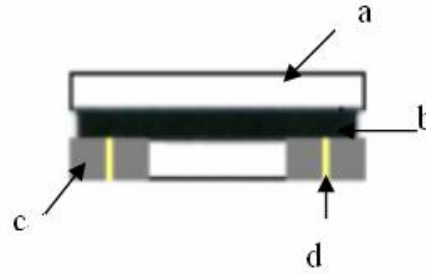

Exposed wire tolerance limit of coating resin part on product side.

Size of exposed wire occurring to coating resin is specified below.

1. Width direction (dimension a) : Acceptable when $a \leq w/2$
Nonconforming when $a > w/2$
2. Length direction (dimension b) : Dimension b is not specified.
3. The total area of exposed wire occurring to each sides is not greater than 50% of coating resin area, and is acceptable.

6. Reliability and Test Condition

Item	Performance	Test Condition
Operating Temperature	-55~+125°C (For products in unopened tape package, less than 40°C)	
Electrical Performance Test		
Inductance L	Refer to standard electrical characteristic list	Agilent-4291, Agilent-4287
DC Resistance		Agilent-4338
Rated Current	Base on temp. rise & $\Delta L/L0A \leq 30\%$.	Saturation DC Current (Isat) will cause L0 to drop approximately $\Delta L(\%)$.
Temperature Rise Test	ΔT 40°C Max	Heat Rated Current (Irms) will cause the coil temperature rise approximately $\Delta T(^{\circ}C)$ without core loss. 1. Applied the allowed DC current. 2. Temperature measured by digital surface thermometer

Item	Performance	Test Condition								
Mechanical Performance Test										
Solder Heat Resistance	Appearance : No damage. Inductance : within±10% of initial value RDC : within ±15% of initial value and shall not exceed the specification value	<table border="1" data-bbox="1064 450 1442 568"> <thead> <tr> <th>Temperature (°C)</th> <th>Time (s)</th> <th>Temperature ramp/immersion and emersion rate</th> <th>Number of heat cycles</th> </tr> </thead> <tbody> <tr> <td>260 ±5 (solder temp)</td> <td>10 ±1</td> <td>25mm/s±6 mm/s</td> <td>1</td> </tr> </tbody> </table> Depth: completely cover the termination	Temperature (°C)	Time (s)	Temperature ramp/immersion and emersion rate	Number of heat cycles	260 ±5 (solder temp)	10 ±1	25mm/s±6 mm/s	1
Temperature (°C)	Time (s)	Temperature ramp/immersion and emersion rate	Number of heat cycles							
260 ±5 (solder temp)	10 ±1	25mm/s±6 mm/s	1							
Solderability Test	More than 95% of terminal electrode should be covered with solder.	Preheat: 150℃,60sec. ° Solder: Sn99.5%-Cu0. 5% ° Temperature: 245±5℃ ° Flux for lead free: Rosin. 9.5% ° Dip time: 4±1sec ° Depth: completely cover the termination								
Reliability Test										
Life Test	Appearance : No damage. Inductance : within±10% of initial value RDC : within ±15% of initial value and shall not exceed the specification value	Preconditioning:Run through IR reflow for 2 times.(IPC/JEDEC J-STD-020DCclassification Reflow Profiles Temperature : 125±2℃ (Bead) Temperature : 85±2℃ (Inductor) Applied current : rated current Duration : 1000±12hrs Measured at room temperature after placing for 24±2 hrs								
Thermal shock		Preconditioning:Run through IR reflow for 2 times.(IPC/JEDEC J-STD-020DCclassification Reflow Profiles Step1 : -40±2℃ 30±5min Step2 : 25±2℃ ≤0.5min Step3 : 105±2℃ 30±5min Number of cycles : 500 Measured at room temprature after placing for 24±2 hrs								
Humidity Resistance Test		Preconditioning:Run through IR reflow for 2 times.(IPC/JEDEC J-STD-020DCclassification Reflow Profiles Humidity : 85±2% R.H, Temperature : 85℃±2℃ Duration : 1000hrs Min. with 100% rated current Measured at room temperature after placing for 24±2 hrs								
Vibration Test		Preconditioning:Run through IR reflow for 2 times.(IPC/JEDEC J-STD-020DCclassification Reflow Profiles Oscillation Frequency: 10~2K~10Hz for 20 minutes Equipment : Vibration checker Total Amplitude:1.52mm±10% Testing Time : 12 hours(20 minutes, 12 cycles each of 3 orientations) °								

7. Soldering and Mounting

7-1. Soldering

Mildly activated rosin fluxes are preferred. TAI-TECH terminations are suitable for all wave and re-flow soldering systems. If hand soldering cannot be avoided, the preferred technique is the utilization of hot air soldering tools.

7-1.1 Solder re-flow:

Recommended temperature profiles for re-flow soldering in Figure 1.

7-1.2 Soldering Iron(Figure 2):

Products attachment with a soldering iron is discouraged due to the inherent process control limitations. In the event that a soldering iron must be employed the following precautions are recommended.

- Preheat circuit and products to 150°C
- Never contact the ceramic with the iron tip
- Use a 20 watt soldering iron with tip diameter of 1.0mm
- 355°C tip temperature (max)
- 1.0mm tip diameter (max)
- Limit soldering time to 4-5 sec.

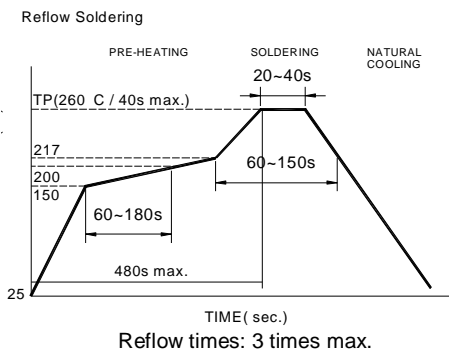

Fig.1

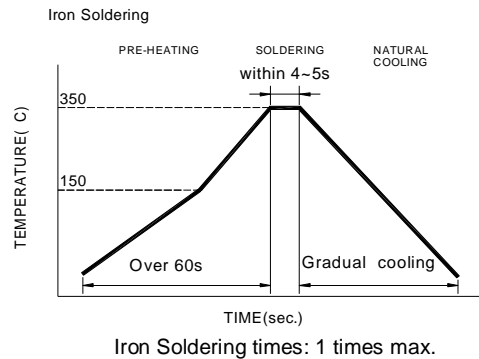
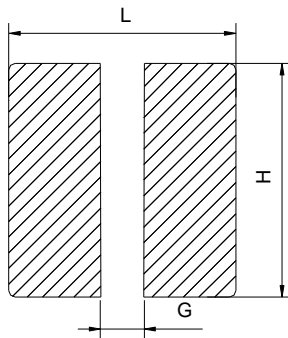

Fig.2

7-2. Recommended PC Board Pattern



L(mm)	G(mm)	H(mm)
2.9	0.8	2.4

8. Packaging Information

8-1. Reel Dimension

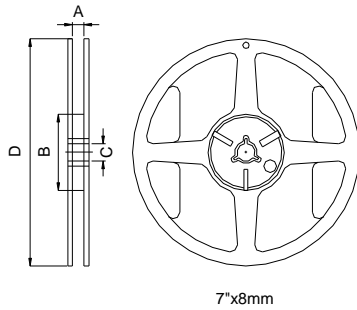

Type	A(mm)	B(mm)	C(mm)	D(mm)
7"x8mm	8.4±1.0	50 min.	13±0.8	178±2

8-2. Tape Dimension / 8mm

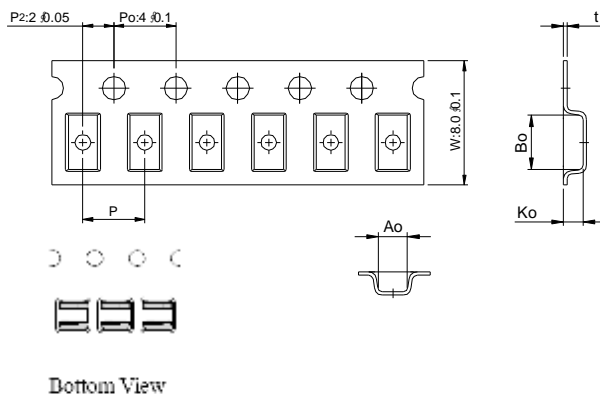

Series	Size	Bo(mm)	Ao(mm)	Ko(mm)	P(mm)	t(mm)
DFP	252010	2.85±0.1	2.45±0.1	1.40±0.1	4.0±0.1	0.23±0.05

8-3. Packaging Quantity

Chip size	252010
Chip / Reel	2000

8-4. Tearing Off Force

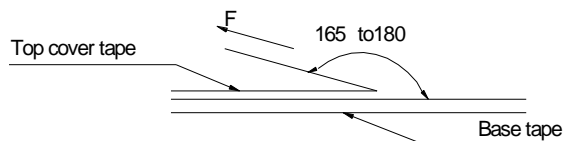

The force for tearing off cover tape is 15 to 80 grams in the arrow direction under the following conditions.

Room Temp. (°C)	Room Humidity (%)	Room atm (hPa)	Tearing Speed mm/min
5~35	45~85	860~1060	300

Application Notice

- Storage Conditions

To maintain the solderability of terminal electrodes:

1. TAI-TECH products meet IPC/JEDEC J-STD-020D standard-MSL, level 1.
2. Temperature and humidity conditions: Less than 40°C and 60% RH.
3. Recommended products should be used within 12 months from the time of delivery.
4. The packaging material should be kept where no chlorine or sulfur exists in the air.

- Transportation

1. Products should be handled with care to avoid damage or contamination from perspiration and skin oils.
2. The use of tweezers or vacuum pick up is strongly recommended for individual components.
3. Bulk handling should ensure that abrasion and mechanical shock are minimized.