

Power Inductor

DFP252010TF-SERIES

1. Features

1. This specification applies Low Profile Power Inductors.
2. 100% Lead(Pb) & Halogen-Free and RoHS compliant.



2. Dimension

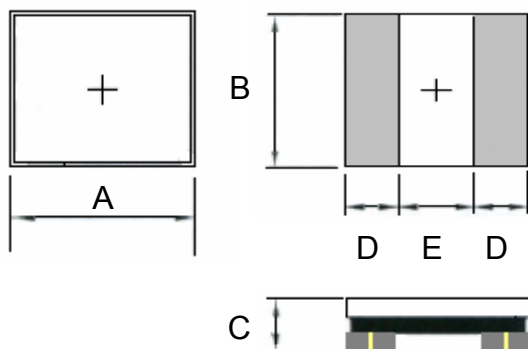

Series	A(mm)	B(mm)	C(mm)	D(mm)	E(mm)
DFP252010TF	2.5 -0.1/+0.2	2.0 -0.10/+0.20	1.0Max	0.85 ref.	0.80 ref.

Units: mm

3. Part Numbering



A: Series
 B: Dimension
 C: Lead Free Material
 D: Inductance R47=0.47uH
 E: Inductance Tolerance M=±20%
 F: Control S/N

4. Specification

TAI-TECH Part Number	Inductance (uH)	Tolerance (%)	Test Frequency (Hz)	DCR (Ω) typ.	DCR (Ω) Max.	I sat (A) typ.	I sat (A) Max.	I rms (A) typ	I rms (A) Max.
DFP252010TF-R24M	0.24	±20%	0.1V/1M	0.029	0.041	4.89	4.38	3.67	3.16
DFP252010TF-R33M	0.33	±20%	0.1V/1M	0.031	0.043	4.38	3.87	3.57	3.06
DFP252010TF-R47M	0.47	±20%	0.1V/1M	0.033	0.045	4.08	3.36	3.47	2.96
DFP252010TF -R68M	0.68	±20%	0.1V/1M	0.045	0.054	3.77	2.96	3.36	2.85
DFP252010TF-1R0M	1.0	±20%	0.1V/1M	0.059	0.079	3.47	2.75	2.65	2.24
DFP252010TF-1R5M	1.5	±20%	0.1V/1M	0.089	0.107	2.75	2.14	2.35	1.94
DFP252010TF-2R2M	2.2	±20%	0.1V/1M	0.128	0.167	2.45	1.94	1.84	1.53

Note:

 Isat : Based on inductance change ($\Delta L/L0 : \leq -30\%$) @ ambient temp. 25°C

 I rms : Based on temperature rise ($\Delta T : 40^{\circ}\text{C}$.) Max

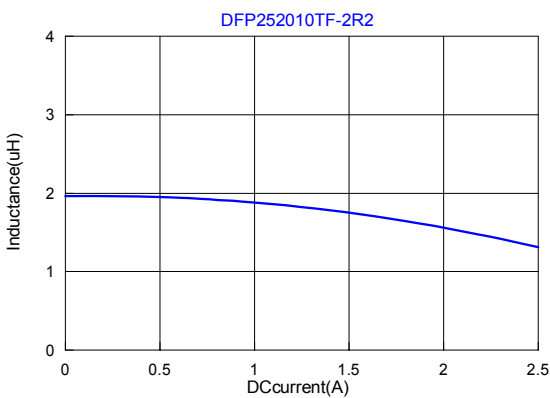
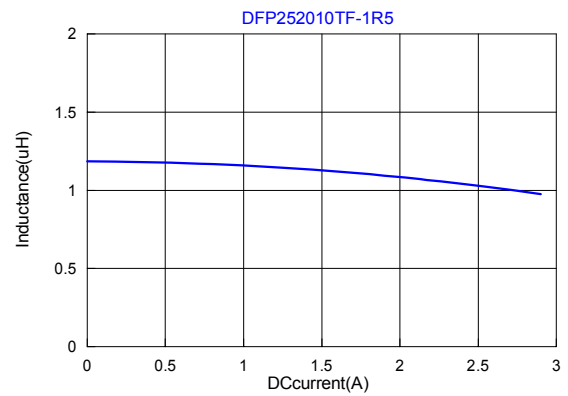
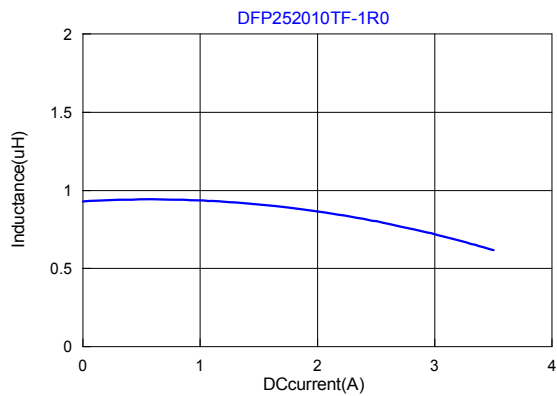
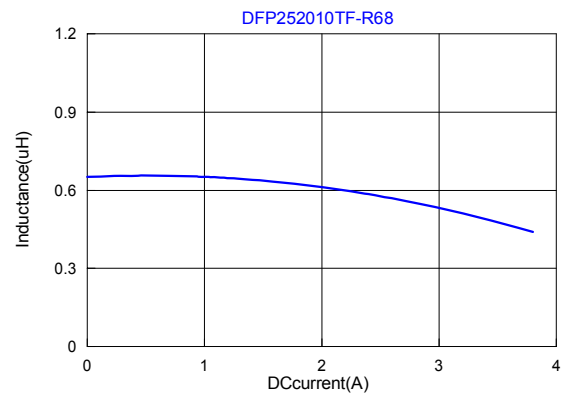
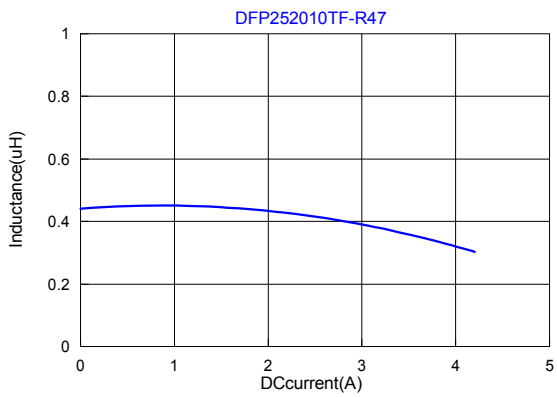
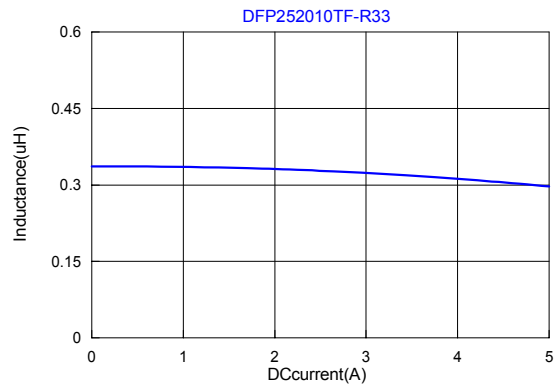
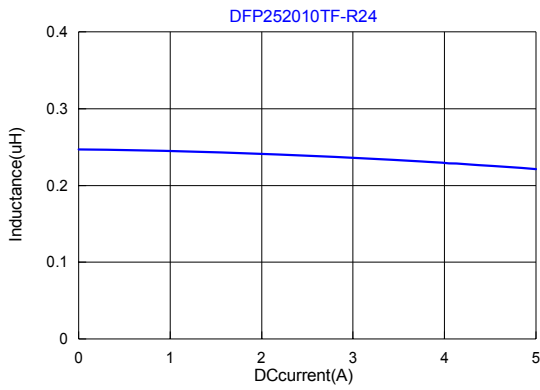

5. Material List

No.	Description	Specification
a.	Core	Ferrite Core
b.	Coating	Epoxy with magnetic powder
c.	Termination	Tin (Pb Free)
d.	Wire	Enameled Copper Wire

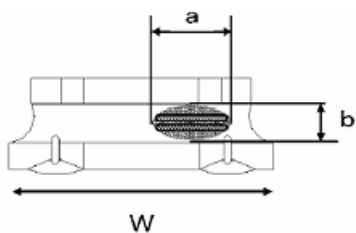
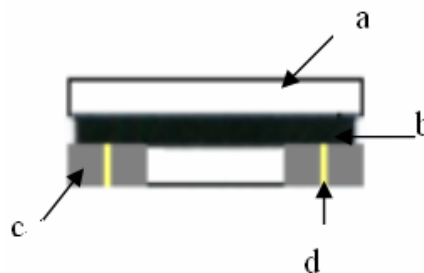

Exposed wire tolerance limit of coating resin part on product side.

Size of exposed wire occurring to coating resin is specified below.

1. Width direction (dimension a) : Acceptable when $a \leq w/2$
Nonconforming when $a > w/2$
2. Length direction (dimension b) : Dimension b is not specified.
3. The total area of exposed wire occurring to each sides is not greater than 50% of coating resin area, and is acceptable.

6. Reliability and Test Condition

Item	Performance	Test Condition
Operating Temperature	-40~+125°C	
Storage Temperature (on board)		
Electrical Performance Test		
Inductance L	Refer to standard electrical characteristic list	Agilent-4291, Agilent-4287
DC Resistance		Agilent-4338
Rated Current	Base on temp. rise & $\Delta L/L0A \leq 30\%$.	Saturation DC Current (Isat) will cause L0 to drop approximately $\Delta L(\%)$.
Temperature Rise Test	$\Delta T 40^\circ C$ Max	Heat Rated Current (Irms) will cause the coil temperature rise approximately $\Delta T(^\circ C)$ without core loss. 1. Applied the allowed DC current. 2. Temperature measured by digital surface thermometer

Item	Performance	Test Condition								
Mechanical Performance Test										
Solder Heat Resistance	Appearance : No damage. Inductance : within±10% of initial value RDC : within ±15% of initial value and shall not exceed the specification value	<table border="1" data-bbox="1062 452 1442 573"> <thead> <tr> <th>Temperature (°C)</th> <th>Time (s)</th> <th>Temperature ramp/immersion and emersion rate</th> <th>Number of heat cycles</th> </tr> </thead> <tbody> <tr> <td>260 ±5 (solder temp)</td> <td>10 ±1</td> <td>25mm/s±6 mm/s</td> <td>1</td> </tr> </tbody> </table> Depth: completely cover the termination	Temperature (°C)	Time (s)	Temperature ramp/immersion and emersion rate	Number of heat cycles	260 ±5 (solder temp)	10 ±1	25mm/s±6 mm/s	1
Temperature (°C)	Time (s)	Temperature ramp/immersion and emersion rate	Number of heat cycles							
260 ±5 (solder temp)	10 ±1	25mm/s±6 mm/s	1							
Solderability Test	More than 95% of terminal electrode should be covered with solder.	Preheat: 150°C ,60sec. ° Solder: Sn99.5%-Cu0. 5% ° Temperature: 245±5°C ° Flux for lead free: Rosin. 9.5% ° Dip time: 4±1sec ° Depth: completely cover the termination								
Reliability Test										
Life Test	Appearance : No damage. Inductance : within±10% of initial value RDC : within ±15% of initial value and shall not exceed the specification value	<u>Preconditioning:Run through IR reflow for 2 times.(IPC/JEDEC J-STD-020DClassification Reflow Profiles</u> Temperature : 85±2°C Applied current : rated current Duration : 1000±12hrs Measured at room temperature after placing for 24±2 hrs								
Thermal shock		<u>Preconditioning:Run through IR reflow for 2 times.(IPC/JEDEC J-STD-020DClassification Reflow Profiles</u> Step1 : -40±2°C 30±5min Step2 : 25±2°C ≤0.5min Step3 : 105±2°C 30±5min Number of cycles : 500 Measured at room temperature after placing for 24±2 hrs								
Humidity Resistance Test		<u>Preconditioning:Run through IR reflow for 2 times.(IPC/JEDEC J-STD-020DClassification Reflow Profiles</u> Humidity : 85±2% R.H, Temperature : 85°C ±2°C Duration : 1000hrs Min. with 100% rated current Measured at room temperature after placing for 24±2 hrs								
Vibration Test		<u>Preconditioning:Run through IR reflow for 2 times.(IPC/JEDEC J-STD-020DClassification Reflow Profiles</u> Oscillation Frequency: 10~2K~10Hz for 20 minutes Equipment : Vibration checker Total Amplitude:1.52mm±10% Testing Time : 12 hours(20 minutes, 12 cycles each of 3 orientations) °								

7. Soldering and Mounting

7-1. Soldering

Mildly activated rosin fluxes are preferred. TAI-TECH terminations are suitable for all wave and re-flow soldering systems. If hand soldering cannot be avoided, the preferred technique is the utilization of hot air soldering tools.

7-1.1 Solder re-flow:

Recommended temperature profiles for re-flow soldering in Figure 1.

7-1.2 Soldering Iron(Figure 2):

Products attachment with a soldering iron is discouraged due to the inherent process control limitations. In the event that a soldering iron must be employed the following precautions are recommended.

- Preheat circuit and products to 150°C
- Never contact the ceramic with the iron tip
- Use a 20 watt soldering iron with tip diameter of 1.0mm
- 355°C tip temperature (max)
- 1.0mm tip diameter (max)
- Limit soldering time to 4~5 sec.

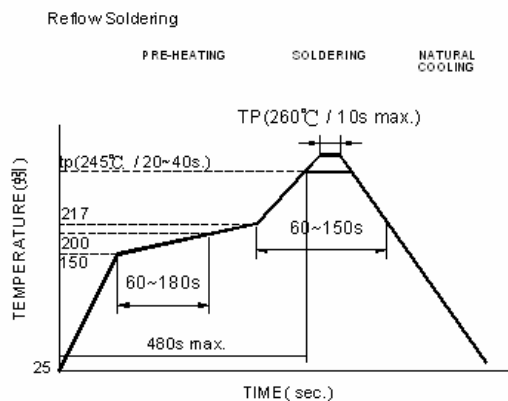

Reflow times: 3 times max.

Fig.1

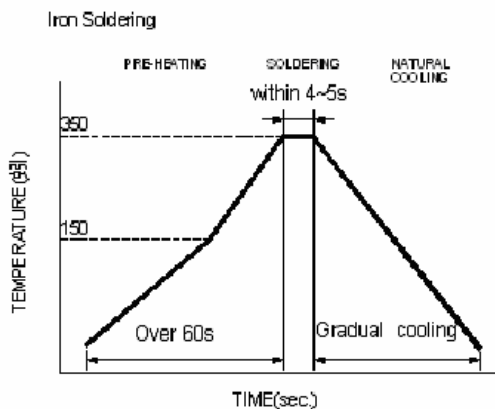

Iron Soldering times: 1 times max.

Fig.2

7-2. Recommended PC Board Pattern

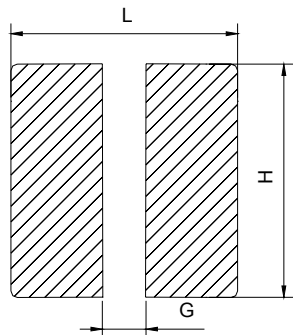

L(mm)	G(mm)	H(mm)
2.9	0.8	2.4

8. Packaging Information

8-1. Reel Dimension

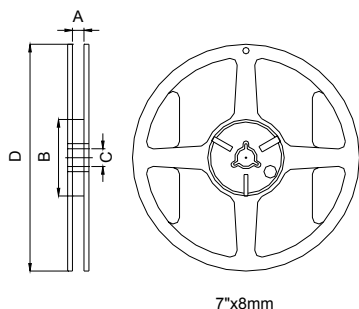

7"x8mm

Type	A(mm)	B(mm)	C(mm)	D(mm)
7"x8mm	8.4±1.0	50 min.	13±0.8	178±2

8-2. Tape Dimension / 8mm

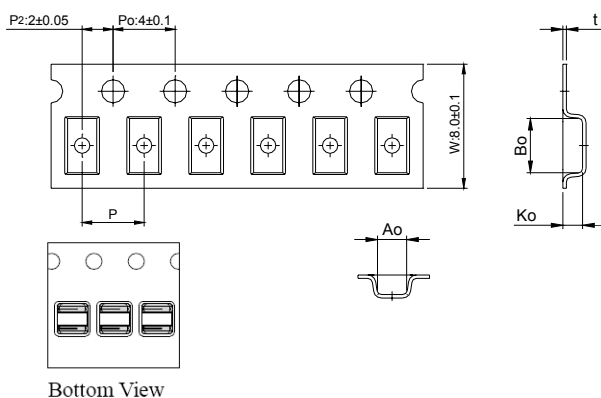

Bottom View

Series	Size	Bo(mm)	Ao(mm)	Ko(mm)	P(mm)	t(mm)
DFP	252010	2.85±0.1	2.45±0.1	1.40±0.1	4.0±0.1	0.23±0.05

8-3. Packaging Quantity

Chip size	252010
Chip / Reel	2000

8-4. Tearing Off Force

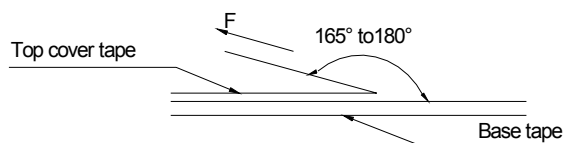

The force for tearing off cover tape is 15 to 80 grams in the arrow direction under the following conditions.

Room Temp. (°C)	Room Humidity (%)	Room atm (hPa)	Tearing Speed mm/min
5~35	45~85	860~1060	300

Application Notice

- Storage Conditions(component level)
 - To maintain the solderability of terminal electrodes:
 1. TAI-TECH products meet IPC/JEDEC J-STD-020D standard-MSL, level 1.
 2. Temperature and humidity conditions: Less than 40°C and 60% RH.
 3. Recommended products should be used within 12 months form the time of delivery.
 4. The packaging material should be kept where no chlorine or sulfur exists in the air.
- Transportation
 1. Products should be handled with care to avoid damage or contamination from perspiration and skin oils.
 2. The use of tweezers or vacuum pick up is strongly recommended for individual components.
 3. Bulk handling should ensure that abrasion and mechanical shock are minimized.

測試報告 Test Report

號碼(No.) : CE/2014/B1174

日期(Date) : 2014/11/17

頁數(Page): 1 of 15

西北臺慶科技股份有限公司 / TAI-TECH ADVANCED ELECTRONICS CO., LTD.

(臺慶精密電子(昆山)有限公司 / TAI-TECH ADVANCED ELECTRONICS (KUN-SHAN) CO. LTD.)

(耀鑽科技股份有限公司 / YOSONIC TECHNOLOGY CO., LTD.)

桃園縣楊梅市幼獅工業區幼四路1號 (NO. 1, YOU 4TH ROAD, YOUTH INDUSTRIAL DISTRICT, YANG-MEI CITY, TAO-YUAN HSIEN, TAIWAN R. O. C.)

(江蘇省昆山市蓬朗區嘉高科技工業區郭澤路 / GUO-ZE ROAD, KUNJIA HI-TECH INDUSTRIAL PARK, KUN-SHAN, JIANG-SU, CHINA)

(桃園縣中壢市中壢工業區長春六路15號 / NO. 15, CHANGCHUN 6TH RD., JHONGLI CITY, TAOYUAN COUNTY 320, TAIWAN)



以下測試樣品係由申請廠商所提供及確認 (The following sample(s) was/were submitted and identified by/on behalf of the applicant as) :

樣品名稱(Sample Description) : SMD POWER INDUCTOR
樣品型號(Style/Item No.) : HPC(YHC, DR), MDC, FPC(YPC), FWP, SPC, SPI, UHP, DFP, DHP, TLPC, TLPH, TLI SERIES
收件日期(Sample Receiving Date) : 2014/11/10
測試期間(Testing Period) : 2014/11/10 TO 2014/11/17

=====
測試結果(Test Results) : 請見下一頁 (Please refer to next pages).



Troy Chang / Manager - Tech
Signed for and on behalf of
SGS TAIWAN LTD.
Chemical Laboratory - Taipei

This document is issued by the Company subject to its General Conditions of Service printed overleaf, available on request or accessible at <http://www.sgs.com/en/Terms-and-Conditions.aspx> and, for electronic format documents, subject to Terms and Conditions for Electronic Documents at <http://www.sgs.com/en/Terms-and-Conditions/Terms-Document.aspx>. Attention is drawn to the limitation of liability, indemnification and jurisdiction issues defined therein. Any holder of this document is advised that information contained hereon reflects the Company's findings at the time of its intervention only and within the limits of client's instruction, if any. The Company's sole responsibility is to its Client and this document does not exonerate parties to a transaction from exercising all their rights and obligations under the transaction documents. This document cannot be reproduced, except in full, without prior written approval of the Company. Any unauthorized alteration, forgery or falsification of the content or appearance of this document is unlawful and offenders may be prosecuted to the fullest extent of the law. Unless otherwise stated the results shown in this test report refer only to the sample(s) tested.



測試報告

Test Report

號碼(No.) : CE/2014/B1174

日期(Date) : 2014/11/17

頁數(Page): 2 of 15

西北臺慶科技股份有限公司 / TAI-TECH ADVANCED ELECTRONICS CO., LTD.

(臺慶精密電子(昆山)有限公司 / TAI-TECH ADVANCED ELECTRONICS (KUN-SHAN) CO. LTD.)

(耀鑽科技股份有限公司 / YOSONIC TECHNOLOGY CO., LTD.)

桃園縣楊梅市幼獅工業區幼四路1號 (NO. 1, YOU 4TH ROAD, YOUTH INDUSTRIAL DISTRICT, YANG-MEI CITY, TAO-YUAN HSIEN, TAIWAN R. O. C.)

(江蘇省昆山市蓬朗昆嘉高科技工業區郭澤路 / GUO-ZE ROAD, KUNJIA HI-TECH INDUSTRIAL PARK, KUN-SHAN, JIANG-SU, CHINA)

(桃園縣中壢市中壢工業區長春六路15號 / NO. 15, CHANGCHUN 6TH RD., JHONGLI CITY, TAOYUAN COUNTY 320, TAIWAN)



測試結果(Test Results)

測試部位(PART NAME)No.1 : 整體混測 (MIXED ALL PARTS)

測試項目 (Test Items)	單位 (Unit)	測試方法 (Method)	方法偵測 極限值 (MDL)	結果 (Result)
				No.1
鎘 / Cadmium (Cd)	mg/kg	參考IEC 62321-5: 2013方法, 以感應耦合電漿原子發射光譜儀檢測. / With reference to IEC 62321-5: 2013 and performed by ICP-AES.	2	n.d.
鉛 / Lead (Pb)	mg/kg	參考IEC 62321-5: 2013方法, 以感應耦合電漿原子發射光譜儀檢測. / With reference to IEC 62321-5: 2013 and performed by ICP-AES.	2	n.d.
汞 / Mercury (Hg)	mg/kg	參考IEC 62321-4: 2013方法, 以感應耦合電漿原子發射光譜儀檢測. / With reference to IEC 62321-4: 2013 and performed by ICP-AES.	2	n.d.
六價鉻 / Hexavalent Chromium Cr(VI)	mg/kg	參考IEC 62321: 2008方法, 以UV-VIS檢測. / With reference to IEC 62321: 2008 and performed by UV-VIS.	2	n.d.
銻 / Antimony (Sb)	mg/kg	參考US EPA 3052方法, 以感應耦合電漿原子發射光譜儀檢測. / With reference to US EPA Method 3052. Analysis was performed by ICP-AES.	2	n.d.
鈹 / Beryllium (Be)	mg/kg	參考US EPA 3052方法, 以感應耦合電漿原子發射光譜儀檢測. / With reference to US EPA Method 3052. Analysis was performed by ICP-AES.	2	n.d.

This document is issued by the Company subject to its General Conditions of Service printed overleaf, available on request or accessible at <http://www.sgs.com/en/Terms-and-Conditions.aspx> and, for electronic format documents, subject to Terms and Conditions for Electronic Documents at <http://www.sgs.com/en/Terms-and-Conditions/Termse-Document.aspx>. Attention is drawn to the limitation of liability, indemnification and jurisdiction issues defined therein. Any holder of this document is advised that information contained hereon reflects the Company's findings at the time of its intervention only and within the limits of client's instruction, if any. The Company's sole responsibility is to its Client and this document does not exonerate parties to a transaction from exercising all their rights and obligations under the transaction documents. This document cannot be reproduced, except in full, without prior written approval of the Company. Any unauthorized alteration, forgery or falsification of the content or appearance of this document is unlawful and offenders may be prosecuted to the fullest extent of the law. Unless otherwise stated the results shown in this test report refer only to the sample(s) tested.



測試報告

Test Report

號碼(No.) : CE/2014/B1174

日期(Date) : 2014/11/17

頁數(Page): 3 of 15

西北臺慶科技股份有限公司 / TAI-TECH ADVANCED ELECTRONICS CO., LTD.

(臺慶精密電子(昆山)有限公司 / TAI-TECH ADVANCED ELECTRONICS (KUN-SHAN) CO. LTD.)

(耀鑽科技股份有限公司 / YOSONIC TECHNOLOGY CO., LTD.)

桃園縣楊梅市幼獅工業區幼四路1號 (NO. 1, YOU 4TH ROAD, YOUTH INDUSTRIAL DISTRICT, YANG-MEI CITY, TAO-YUAN HSIEN, TAIWAN R. O. C.)

(江蘇省昆山市蓬朗區嘉高科技工業區郭澤路 / GUO-ZE ROAD, KUNJIA HI-TECH INDUSTRIAL PARK, KUN-SHAN, JIANG-SU, CHINA)

(桃園縣中壢市中壢工業區長春六路15號 / NO. 15, CHANGCHUN 6TH RD., JHONGLI CITY, TAOYUAN COUNTY 320, TAIWAN)



測試項目 (Test Items)	單位 (Unit)	測試方法 (Method)	方法偵測 極限值 (MDL)	結果 (Result)
				No.1
鄰苯二甲酸丁苯甲酯 / BBP (Butyl Benzyl phthalate) (CAS No.: 85-68-7)	%	參考EN 14372, 以氣相層析/質譜儀檢測。 / With reference to EN 14372. Analysis was performed by GC/MS.	0.003	n.d.
鄰苯二甲酸二(2-乙基己基)酯 / DEHP (Di-(2-ethylhexyl) phthalate) (CAS No.: 117-81-7)	%	參考EN 14372, 以氣相層析/質譜儀檢測。 / With reference to EN 14372. Analysis was performed by GC/MS.	0.003	n.d.
鄰苯二甲酸二異癸酯 / DIDP (Di-isodecyl phthalate) (CAS No.: 26761-40-0; 68515-49-1)	%	參考EN 14372, 以氣相層析/質譜儀檢測。 / With reference to EN 14372. Analysis was performed by GC/MS.	0.01	n.d.
鄰苯二甲酸二異壬酯 / DINP (Di-isononyl phthalate) (CAS No.: 28553-12-0; 68515-48-0)	%	參考EN 14372, 以氣相層析/質譜儀檢測。 / With reference to EN 14372. Analysis was performed by GC/MS.	0.01	n.d.
鄰苯二甲酸二正辛酯 / DNOP (Di-n-octyl phthalate) (CAS No.: 117-84-0)	%	參考EN 14372, 以氣相層析/質譜儀檢測。 / With reference to EN 14372. Analysis was performed by GC/MS.	0.003	n.d.
鄰苯二甲酸二丁酯 / DBP (Dibutyl phthalate) (CAS No.: 84-74-2)	%	參考EN 14372, 以氣相層析/質譜儀檢測。 / With reference to EN 14372. Analysis was performed by GC/MS.	0.003	n.d.
鄰苯二甲酸二異丁酯 / DIBP (Di-isobutyl phthalate) (CAS No.: 84-69-5)	%	參考EN 14372, 以氣相層析/質譜儀檢測。 / With reference to EN 14372. Analysis was performed by GC/MS.	0.003	n.d.
聚氯乙稀 / PVC	**	以紅外光譜分析及焰色法檢測。 / Analysis was performed by FTIR and FLAME Test.	-	Negative

This document is issued by the Company subject to its General Conditions of Service printed overleaf, available on request or accessible at <http://www.sgs.com/en/Terms-and-Conditions.aspx> and, for electronic format documents, subject to Terms and Conditions for Electronic Documents at <http://www.sgs.com/en/Terms-and-Conditions/Termse-Documents.aspx>. Attention is drawn to the limitation of liability, indemnification and jurisdiction issues defined therein. Any holder of this document is advised that information contained hereon reflects the Company's findings at the time of its intervention only and within the limits of client's instruction, if any. The Company's sole responsibility is to its Client and this document does not exonerate parties to a transaction from exercising all their rights and obligations under the transaction documents. This document cannot be reproduced, except in full, without prior written approval of the Company. Any unauthorized alteration, forgery or falsification of the content or appearance of this document is unlawful and offenders may be prosecuted to the fullest extent of the law. Unless otherwise stated the results shown in this test report refer only to the sample(s) tested.



測試報告

Test Report

號碼(No.) : CE/2014/B1174

日期(Date) : 2014/11/17

頁數(Page): 4 of 15

西北臺慶科技股份有限公司 / TAI-TECH ADVANCED ELECTRONICS CO., LTD.

(臺慶精密電子(昆山)有限公司 / TAI-TECH ADVANCED ELECTRONICS (KUN-SHAN) CO. LTD.)

(耀鑽科技股份有限公司 / YOSONIC TECHNOLOGY CO., LTD.)

桃園縣楊梅市幼獅工業區幼四路1號 (NO. 1, YOU 4TH ROAD, YOUTH INDUSTRIAL DISTRICT, YANG-MEI CITY, TAO-YUAN HSIEN, TAIWAN R. O. C.)

(江蘇省昆山市蓬朗區嘉高科技工業區郭澤路 / GUO-ZE ROAD, KUNJIA HI-TECH INDUSTRIAL PARK, KUN-SHAN, JIANG-SU, CHINA)

(桃園縣中壢市中壢工業區長春六路15號 / NO. 15, CHANGCHUN 6TH RD., JHONGLI CITY, TAOYUAN COUNTY 320, TAIWAN)



測試項目 (Test Items)	單位 (Unit)	測試方法 (Method)	方法偵測 極限值 (MDL)	結果 (Result)
				No.1
全氟辛烷磺酸 / Perfluorooctane sulfonates (PFOS-Acid, Metal Salt, Amide)	mg/kg	參考US EPA 3550C: 2007方法, 以液相層析/質譜儀檢測. / With reference to US EPA 3550C: 2007. Analysis was performed by LC/MS.	10	n.d.
全氟辛酸 / PFOA (CAS No.: 335-67-1)	mg/kg	參考US EPA 3550C: 2007方法, 以液相層析/質譜儀檢測. / With reference to US EPA 3550C: 2007. Analysis was performed by LC/MS.	10	n.d.
六溴環十二烷及所有主要被辨別出的異構物 / Hexabromocyclododecane (HBCDD) and all major diastereoisomers identified (α - HBCDD, β - HBCDD, γ - HBCDD) (CAS No.: 25637-99-4 and 3194-55-6 (134237-51-7, 134237-50-6, 134237-52-8))	mg/kg	參考IEC 62321: 2008方法, 以氣相層析/質譜儀檢測. / With reference to IEC 62321: 2008 method. Analysis was performed by GC/MS.	5	n.d.
鹵素 / Halogen				
鹵素 (氟) / Halogen-Fluorine (F) (CAS No.: 14762-94-8)	mg/kg	參考BS EN 14582:2007, 以離子層析儀分析. / With reference to BS EN 14582:2007. Analysis was performed by IC.	50	n.d.
鹵素 (氯) / Halogen-Chlorine (Cl) (CAS No.: 22537-15-1)	mg/kg		50	n.d.
鹵素 (溴) / Halogen-Bromine (Br) (CAS No.: 10097-32-2)	mg/kg		50	n.d.
鹵素 (碘) / Halogen-Iodine (I) (CAS No.: 14362-44-8)	mg/kg		50	n.d.

This document is issued by the Company subject to its General Conditions of Service printed overleaf, available on request or accessible at <http://www.sgs.com/en/Terms-and-Conditions.aspx> and, for electronic format documents, subject to Terms and Conditions for Electronic Documents at <http://www.sgs.com/en/Terms-and-Conditions/Termse-Documents.aspx>. Attention is drawn to the limitation of liability, indemnification and jurisdiction issues defined therein. Any holder of this document is advised that information contained hereon reflects the Company's findings at the time of its intervention only and within the limits of client's instruction, if any. The Company's sole responsibility is to its Client and this document does not exonerate parties to a transaction from exercising all their rights and obligations under the transaction documents. This document cannot be reproduced, except in full, without prior written approval of the Company. Any unauthorized alteration, forgery or falsification of the content or appearance of this document is unlawful and offenders may be prosecuted to the fullest extent of the law. Unless otherwise stated the results shown in this test report refer only to the sample(s) tested.



測試報告

Test Report

號碼(No.) : CE/2014/B1174

日期(Date) : 2014/11/17

頁數(Page): 5 of 15

西北臺慶科技股份有限公司 / TAI-TECH ADVANCED ELECTRONICS CO., LTD.

(臺慶精密電子(昆山)有限公司 / TAI-TECH ADVANCED ELECTRONICS (KUN-SHAN) CO. LTD.)

(耀鑽科技股份有限公司 / YOSONIC TECHNOLOGY CO., LTD.)

桃園縣楊梅市幼獅工業區幼四路1號 (NO. 1, YOU 4TH ROAD, YOUTH INDUSTRIAL DISTRICT, YANG-MEI CITY, TAO-YUAN HSIEN, TAIWAN R. O. C.)

(江蘇省昆山市蓬朗區嘉高科技工業區郭澤路 / GUO-ZE ROAD, KUNJIA HI-TECH INDUSTRIAL PARK, KUN-SHAN, JIANG-SU, CHINA)

(桃園縣中壢市中壢工業區長春六路15號 / NO. 15, CHANGCHUN 6TH RD., JHONGLI CITY, TAOYUAN COUNTY 320, TAIWAN)



測試項目 (Test Items)	單位 (Unit)	測試方法 (Method)	方法偵測 極限值 (MDL)	結果 (Result)
				No.1
多溴聯苯總和 / Sum of PBBs	mg/kg	參考IEC 62321: 2008方法, 以氣相層析/ 質譜儀檢測. / With reference to IEC 62321: 2008 and performed by GC/MS.	-	n.d.
一溴聯苯 / Monobromobiphenyl	mg/kg		5	n.d.
二溴聯苯 / Dibromobiphenyl	mg/kg		5	n.d.
三溴聯苯 / Tribromobiphenyl	mg/kg		5	n.d.
四溴聯苯 / Tetrabromobiphenyl	mg/kg		5	n.d.
五溴聯苯 / Pentabromobiphenyl	mg/kg		5	n.d.
六溴聯苯 / Hexabromobiphenyl	mg/kg		5	n.d.
七溴聯苯 / Heptabromobiphenyl	mg/kg		5	n.d.
八溴聯苯 / Octabromobiphenyl	mg/kg		5	n.d.
九溴聯苯 / Nonabromobiphenyl	mg/kg		5	n.d.
十溴聯苯 / Decabromobiphenyl	mg/kg		5	n.d.
多溴聯苯醚總和 / Sum of PBDEs	mg/kg		-	n.d.
一溴聯苯醚 / Monobromodiphenyl ether	mg/kg		5	n.d.
二溴聯苯醚 / Dibromodiphenyl ether	mg/kg		5	n.d.
三溴聯苯醚 / Tribromodiphenyl ether	mg/kg		5	n.d.
四溴聯苯醚 / Tetrabromodiphenyl ether	mg/kg		5	n.d.
五溴聯苯醚 / Pentabromodiphenyl ether	mg/kg		5	n.d.
六溴聯苯醚 / Hexabromodiphenyl ether	mg/kg		5	n.d.
七溴聯苯醚 / Heptabromodiphenyl ether	mg/kg		5	n.d.
八溴聯苯醚 / Octabromodiphenyl ether	mg/kg		5	n.d.
九溴聯苯醚 / Nonabromodiphenyl ether	mg/kg	5	n.d.	
十溴聯苯醚 / Decabromodiphenyl ether	mg/kg	5	n.d.	

This document is issued by the Company subject to its General Conditions of Service printed overleaf, available on request or accessible at <http://www.sgs.com/en/Terms-and-Conditions.aspx> and, for electronic format documents, subject to Terms and Conditions for Electronic Documents at <http://www.sgs.com/en/Terms-and-Conditions/Termse-Documents.aspx>. Attention is drawn to the limitation of liability, indemnification and jurisdiction issues defined therein. Any holder of this document is advised that information contained hereon reflects the Company's findings at the time of its intervention only and within the limits of client's instruction, if any. The Company's sole responsibility is to its Client and this document does not exonerate parties to a transaction from exercising all their rights and obligations under the transaction documents. This document cannot be reproduced, except in full, without prior written approval of the Company. Any unauthorized alteration, forgery or falsification of the content or appearance of this document is unlawful and offenders may be prosecuted to the fullest extent of the law. Unless otherwise stated the results shown in this test report refer only to the sample(s) tested.



測試報告

Test Report

號碼(No.) : CE/2014/B1174

日期(Date) : 2014/11/17

頁數(Page): 6 of 15

西北臺慶科技股份有限公司 / TAI-TECH ADVANCED ELECTRONICS CO., LTD.

(臺慶精密電子(昆山)有限公司 / TAI-TECH ADVANCED ELECTRONICS (KUN-SHAN) CO. LTD.)

(耀鑽科技股份有限公司 / YOSONIC TECHNOLOGY CO., LTD.)

桃園縣楊梅市幼獅工業區幼四路1號 (NO. 1, YOU 4TH ROAD, YOUTH INDUSTRIAL DISTRICT, YANG-MEI CITY, TAO-YUAN HSIEN, TAIWAN R. O. C.)

(江蘇省昆山市蓬朗區嘉高科技工業區郭澤路 / GUO-ZE ROAD, KUNJIA HI-TECH INDUSTRIAL PARK, KUN-SHAN, JIANG-SU, CHINA)

(桃園縣中壢市中壢工業區長春六路15號 / NO. 15, CHANGCHUN 6TH RD., JHONGLI CITY, TAOYUAN COUNTY 320, TAIWAN)



備註(Note) :

1. mg/kg = ppm ; 0.1wt% = 1000ppm
2. n.d. = Not Detected (未檢出)
3. MDL = Method Detection Limit (方法偵測極限值)
4. "-" = Not Regulated (無規格值)
5. ** = Qualitative analysis (No Unit) 定性分析(無單位)
6. Negative = Undetectable 陰性(未偵測到); Positive = Detectable 陽性(已偵測到)
7. 樣品的測試是基於申請人要求混合測試, 報告中的混合測試結果不代表其中個別單一材質的含量. (The samples was/were analyzed on behalf of the applicant as mixing sample in one testing. The above results was/were only given as the informality value.)

PFOS參考資訊(Reference Information) : 持久性有機污染物 POPs - (EU) 757/2010

PFOS濃度在物質或製備中不得超過0.001%(10ppm), 在半成品、成品或零部件中不得超過0.1%(1000ppm), 在紡織品或塗層材料中不得超過 $1\mu\text{g}/\text{m}^2$ 。

(Outlawing PFOS as substances or preparations in concentrations above 0.001% (10ppm), in semi-finished products or articles or parts at a level above 0.1%(1000ppm), in textiles or other coated materials above $1\mu\text{g}/\text{m}^2$.)

This document is issued by the Company subject to its General Conditions of Service printed overleaf, available on request or accessible at <http://www.sgs.com/en/Terms-and-Conditions.aspx> and, for electronic format documents, subject to Terms and Conditions for Electronic Documents at <http://www.sgs.com/en/Terms-and-Conditions/Termse-Documents.aspx>. Attention is drawn to the limitation of liability, indemnification and jurisdiction issues defined therein. Any holder of this document is advised that information contained hereon reflects the Company's findings at the time of its intervention only and within the limits of client's instruction, if any. The Company's sole responsibility is to its Client and this document does not exonerate parties to a transaction from exercising all their rights and obligations under the transaction documents. This document cannot be reproduced, except in full, without prior written approval of the Company. Any unauthorized alteration, forgery or falsification of the content or appearance of this document is unlawful and offenders may be prosecuted to the fullest extent of the law. Unless otherwise stated the results shown in this test report refer only to the sample(s) tested.

測試報告 Test Report

號碼(No.) : CE/2014/B1174

日期(Date) : 2014/11/17

頁數(Page): 7 of 15

西北臺慶科技股份有限公司 / TAI-TECH ADVANCED ELECTRONICS CO., LTD.

(臺慶精密電子(昆山)有限公司 / TAI-TECH ADVANCED ELECTRONICS (KUN-SHAN) CO. LTD.)

(耀鑽科技股份有限公司 / YOSONIC TECHNOLOGY CO., LTD.)

桃園縣楊梅市幼獅工業區幼四路1號 (NO. 1, YOU 4TH ROAD, YOUTH INDUSTRIAL DISTRICT, YANG-MEI CITY, TAO-YUAN HSIEN, TAIWAN R. O. C.)

(江蘇省昆山市蓬朗區嘉高科技工業區郭澤路 / GUO-ZE ROAD, KUNJIA HI-TECH INDUSTRIAL PARK, KUN-SHAN, JIANG-SU, CHINA)

(桃園縣中壢市中壢工業區長春六路15號 / NO. 15, CHANGCHUN 6TH RD., JHONGLI CITY, TAOYUAN COUNTY 320, TAIWAN)

- 1) 根據以下的流程圖之條件，樣品已完全溶解。(六價鉻測試方法除外) / These samples were dissolved totally by pre-conditioning method according to below flow chart. (Cr⁶⁺ test method excluded)
- 2) 測試人員：楊登偉 / Name of the person who made measurement: Climbgreat Yang
- 3) 測試負責人：張啓興 / Name of the person in charge of measurement: Troy Chang

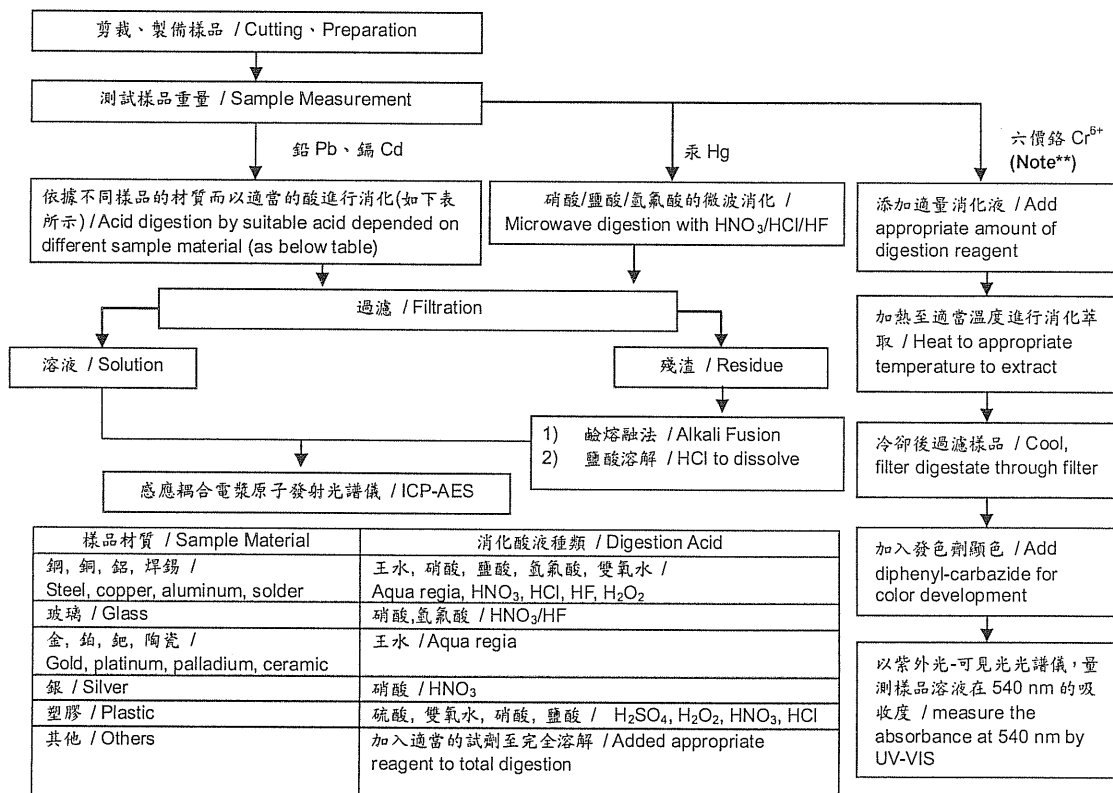

Note**: (1) 針對非金屬材料加入鹼性消化液，加熱至90-95°C萃取。 / For non-metallic material, add alkaline digestion reagent and heat to 90-95°C.
 (2) 針對金屬材料加入純水，加熱至沸騰萃取。 / For metallic material, add pure water and heat to boiling.

This document is issued by the Company subject to its General Conditions of Service printed overleaf, available on request or accessible at <http://www.sgs.com/en/Terms-and-Conditions.aspx> and, for electronic format documents, subject to Terms and Conditions for Electronic Documents at <http://www.sgs.com/en/Terms-and-Conditions/Termse-Documents.aspx>. Attention is drawn to the limitation of liability, indemnification and jurisdiction issues defined therein. Any holder of this document is advised that information contained hereon reflects the Company's findings at the time of its intervention only and within the limits of client's instruction, if any. The Company's sole responsibility is to its Client and this document does not exonerate parties to a transaction from exercising all their rights and obligations under the transaction documents. This document cannot be reproduced, except in full, without prior written approval of the Company. Any unauthorized alteration, forgery or falsification of the content or appearance of this document is unlawful and offenders may be prosecuted to the fullest extent of the law. Unless otherwise stated the results shown in this test report refer only to the sample(s) tested.

測試報告 Test Report

號碼(No.) : CE/2014/B1174

日期(Date) : 2014/11/17

頁數(Page): 8 of 15

西北臺慶科技股份有限公司 / TAI-TECH ADVANCED ELECTRONICS CO., LTD.

(臺慶精密電子(昆山)有限公司 / TAI-TECH ADVANCED ELECTRONICS (KUN-SHAN) CO. LTD.)

(耀鑽科技股份有限公司 / YOSONIC TECHNOLOGY CO., LTD.)

桃園縣楊梅市幼獅工業區幼四路1號 (NO. 1, YOU 4TH ROAD, YOUTH INDUSTRIAL DISTRICT, YANG-MEI CITY, TAO-YUAN HSIEN, TAIWAN R. O. C.)

(江蘇省昆山市蓬朗區高科技工業區郭澤路 / GUO-ZE ROAD, KUNJIA HI-TECH INDUSTRIAL PARK, KUN-SHAN, JIANG-SU, CHINA)

(桃園縣中壢市中壢工業區長春六路15號 / NO. 15, CHANGCHUN 6TH RD., JHONGLI CITY, TAOYUAN COUNTY 320, TAIWAN)



- 1) 根據以下的流程圖之條件，樣品已完全溶解。 / These samples were dissolved totally by pre-conditioning method according to below flow chart.
- 2) 測試人員：楊登偉 / Name of the person who made measurement: Climbgreat Yang
- 3) 測試負責人：張啓興 / Name of the person in charge of measurement: Troy Chang

元素以 ICP-AES 分析的消化流程圖

(Flow Chart of digestion for the elements analysis performed by ICP-AES)

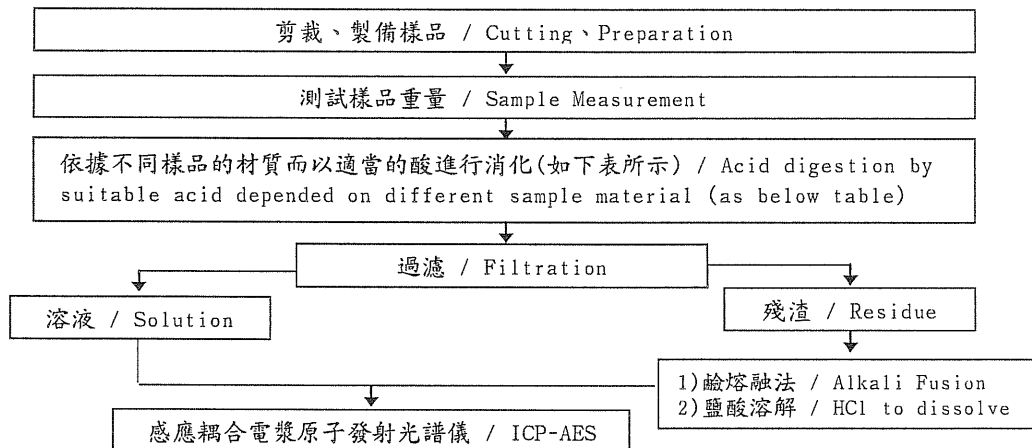

鋼, 銅, 鋁, 焊錫 / Steel, copper, aluminum, solder	王水, 硝酸, 鹽酸, 氫氟酸, 雙氧水 / Aqua regia, HNO ₃ , HCl, HF, H ₂ O ₂
玻璃 / Glass	硝酸, 氫氟酸 / HNO ₃ /HF
金, 鉑, 鈀, 陶瓷 / Gold, platinum, palladium, ceramic	王水 / Aqua regia
銀 / Silver	硝酸 / HNO ₃
塑膠 / Plastic	硫酸, 雙氧水, 硝酸, 鹽酸 / H ₂ SO ₄ , H ₂ O ₂ , HNO ₃ , HCl
其他 / Others	加入適當的試劑至完全溶解 / Added appropriate reagent to total digestion

This document is issued by the Company subject to its General Conditions of Service printed overleaf, available on request or accessible at <http://www.sgs.com/en/Terms-and-Conditions.aspx> and, for electronic format documents, subject to Terms and Conditions for Electronic Documents at <http://www.sgs.com/en/Terms-and-Conditions/Termse-Documents.aspx>. Attention is drawn to the limitation of liability, indemnification and jurisdiction issues defined therein. Any holder of this document is advised that information contained hereon reflects the Company's findings at the time of its intervention only and within the limits of client's instruction, if any. The Company's sole responsibility is to its Client and this document does not exonerate parties to a transaction from exercising all their rights and obligations under the transaction documents. This document cannot be reproduced, except in full, without prior written approval of the Company. Any unauthorized alteration, forgery or falsification of the content or appearance of this document is unlawful and offenders may be prosecuted to the fullest extent of the law. Unless otherwise stated the results shown in this test report refer only to the sample(s) tested.

測試報告

Test Report

號碼(No.) : CE/2014/B1174

日期(Date) : 2014/11/17

頁數(Page): 9 of 15

西北臺慶科技股份有限公司 / TAI-TECH ADVANCED ELECTRONICS CO., LTD.

(臺慶精密電子(昆山)有限公司 / TAI-TECH ADVANCED ELECTRONICS (KUN-SHAN) CO. LTD.)

(耀鑽科技股份有限公司 / YOSONIC TECHNOLOGY CO., LTD.)

桃園縣楊梅市幼獅工業區幼四路1號 (NO. 1, YOU 4TH ROAD, YOUTH INDUSTRIAL DISTRICT, YANG-MEI CITY, TAO-YUAN HSIEN, TAIWAN R. O. C.)

(江蘇省昆山市蓬朗區嘉高科技工業區郭澤路 / GUO-ZE ROAD, KUNJIA HI-TECH INDUSTRIAL PARK, KUN-SHAN, JIANG-SU, CHINA)

(桃園縣中壢市中壢工業區長春六路15號 / NO. 15, CHANGCHUN 6TH RD., JHONGLI CITY, TAOYUAN COUNTY 320, TAIWAN)



聚氯乙稀物質判定分析流程圖 /

Analysis flow chart for determination of PVC in material

- 測試人員：林建宇 / Name of the person who made measurement: Roy Lin
- 測試負責人：張啓興 / Name of the person in charge of measurement: Troy Chang

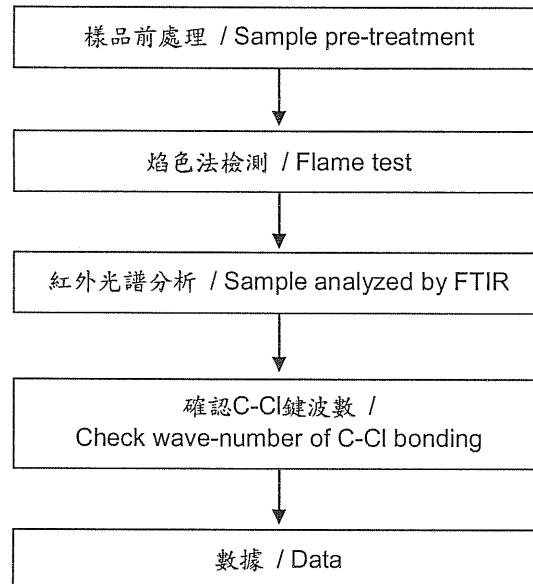

This document is issued by the Company subject to its General Conditions of Service printed overleaf, available on request or accessible at <http://www.sgs.com/en/Terms-and-Conditions.aspx> and, for electronic format documents, subject to Terms and Conditions for Electronic Documents at <http://www.sgs.com/en/Terms-and-Conditions/Termse-Documents.aspx>. Attention is drawn to the limitation of liability, indemnification and jurisdiction issues defined therein. Any holder of this document is advised that information contained hereon reflects the Company's findings at the time of its intervention only and within the limits of client's instruction, if any. The Company's sole responsibility is to its Client and this document does not exonerate parties to a transaction from exercising all their rights and obligations under the transaction documents. This document cannot be reproduced, except in full, without prior written approval of the Company. Any unauthorized alteration, forgery or falsification of the content or appearance of this document is unlawful and offenders may be prosecuted to the fullest extent of the law. Unless otherwise stated the results shown in this test report refer only to the sample(s) tested.

測試報告 Test Report

號碼(No.) : CE/2014/B1174

日期(Date) : 2014/11/17

頁數(Page): 10 of 15

西北臺慶科技股份有限公司 / TAI-TECH ADVANCED ELECTRONICS CO., LTD.

(臺慶精密電子(昆山)有限公司 / TAI-TECH ADVANCED ELECTRONICS (KUN-SHAN) CO. LTD.)

(耀鑽科技股份有限公司 / YOSONIC TECHNOLOGY CO., LTD.)

桃園縣楊梅市幼獅工業區幼四路1號 (NO. 1, YOU 4TH ROAD, YOUTH INDUSTRIAL DISTRICT, YANG-MEI CITY, TAO-YUAN HSIEN, TAIWAN R. O. C.)

(江蘇省昆山市蓬朗區嘉高科技工業區郭澤路 / GUO-ZE ROAD, KUNJIA HI-TECH INDUSTRIAL PARK, KUN-SHAN, JIANG-SU, CHINA)

(桃園縣中壢市中壢工業區長春六路15號 / NO. 15, CHANGCHUN 6TH RD., JHONGLI CITY, TAOYUAN COUNTY 320, TAIWAN)



全氟辛酸/全氟辛烷磺酸分析流程圖 / PFOA/PFOS analytical flow chart

- 測試人員：翁賜彬 / Name of the person who made measurement: Roman Wong
- 測試負責人：張啓興 / Name of the person in charge of measurement: Troy Chang

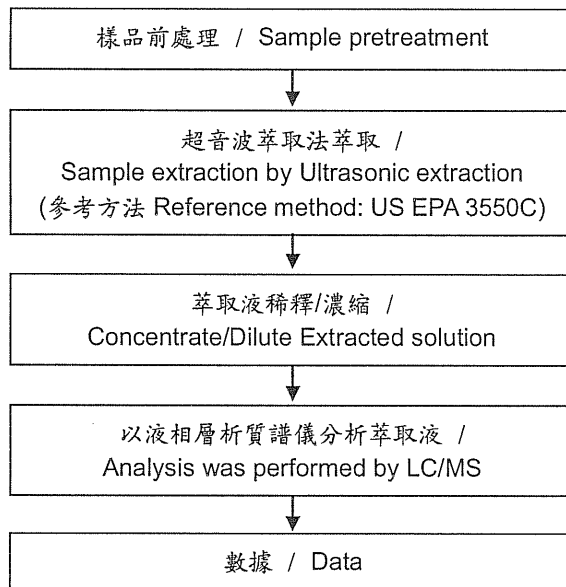

This document is issued by the Company subject to its General Conditions of Service printed overleaf, available on request or accessible at <http://www.sgs.com/en/Terms-and-Conditions.aspx> and, for electronic format documents, subject to Terms and Conditions for Electronic Documents at <http://www.sgs.com/en/Terms-and-Conditions/Termse-Documents.aspx>. Attention is drawn to the limitation of liability, indemnification and jurisdiction issues defined therein. Any holder of this document is advised that information contained hereon reflects the Company's findings at the time of its intervention only and within the limits of client's instruction, if any. The Company's sole responsibility is to its Client and this document does not exonerate parties to a transaction from exercising all their rights and obligations under the transaction documents. This document cannot be reproduced, except in full, without prior written approval of the Company. Any unauthorized alteration, forgery or falsification of the content or appearance of this document is unlawful and offenders may be prosecuted to the fullest extent of the law. Unless otherwise stated the results shown in this test report refer only to the sample(s) tested.

測試報告 Test Report

號碼(No.) : CE/2014/B1174

日期(Date) : 2014/11/17

頁數(Page): 11 of 15

西北臺慶科技股份有限公司 / TAI-TECH ADVANCED ELECTRONICS CO., LTD.

(臺慶精密電子(昆山)有限公司 / TAI-TECH ADVANCED ELECTRONICS (KUN-SHAN) CO. LTD.)

(耀鑽科技股份有限公司 / YOSONIC TECHNOLOGY CO., LTD.)

桃園縣楊梅市幼獅工業區幼四路1號 (NO. 1, YOU 4TH ROAD, YOUTH INDUSTRIAL DISTRICT, YANG-MEI CITY, TAO-YUAN HSIEN, TAIWAN R. O. C.)

(江蘇省昆山市蓬朗昆嘉高科技工業區郭澤路 / GUO-ZE ROAD, KUNJIA HI-TECH INDUSTRIAL PARK, KUN-SHAN, JIANG-SU, CHINA)

(桃園縣中壢市中壢工業區長春六路15號 / NO. 15, CHANGCHUN 6TH RD., JHONGLI CITY, TAOYUAN COUNTY 320, TAIWAN)



鹵素分析流程圖 / Analytical flow chart of halogen content

- 測試人員：陳恩臻 / Name of the person who made measurement: Rita Chen
- 測試負責人：張啓興 / Name of the person in charge of measurement: Troy Chang

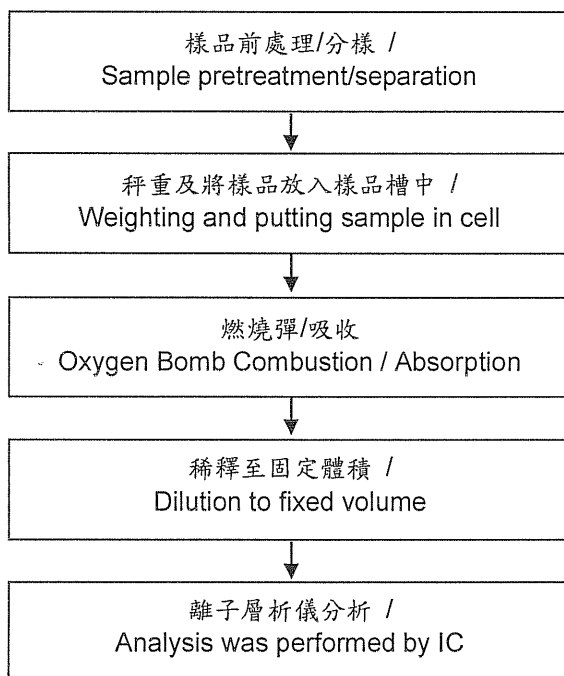

測試報告

Test Report

號碼(No.) : CE/2014/B1174

日期(Date) : 2014/11/17

頁數(Page): 12 of 15

西北臺慶科技股份有限公司 / TAI-TECH ADVANCED ELECTRONICS CO., LTD.

(臺慶精密電子(昆山)有限公司 / TAI-TECH ADVANCED ELECTRONICS (KUN-SHAN) CO. LTD.)

(耀鑽科技股份有限公司 / YOSONIC TECHNOLOGY CO., LTD.)

桃園縣楊梅市幼獅工業區幼四路1號 (NO. 1, YOU 4TH ROAD, YOUTH INDUSTRIAL DISTRICT, YANG-MEI CITY, TAO-YUAN HSIEN, TAIWAN R. O. C.)

(江蘇省昆山市蓬朗昆嘉高科技工業區郭澤路 / GUO-ZE ROAD, KUNJIA HI-TECH INDUSTRIAL PARK, KUN-SHAN, JIANG-SU, CHINA)

(桃園縣中壢市中壢工業區長春六路15號 / NO. 15, CHANGCHUN 6TH RD., JHONGLI CITY, TAOYUAN COUNTY 320, TAIWAN)



可塑劑分析流程圖 / Analytical flow chart of phthalate content

- 測試人員：翁賜彬 / Name of the person who made measurement: Roman Wong
- 測試負責人：張啓興 / Name of the person in charge of measurement: Troy Chang

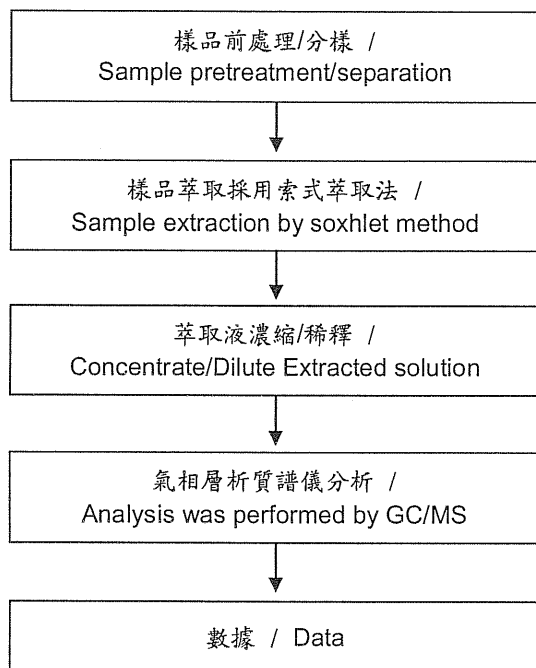

This document is issued by the Company subject to its General Conditions of Service printed overleaf, available on request or accessible at <http://www.sgs.com/en/Terms-and-Conditions.aspx> and, for electronic format documents, subject to Terms and Conditions for Electronic Documents at <http://www.sgs.com/en/Terms-and-Conditions/Termse-Documents.aspx>. Attention is drawn to the limitation of liability, indemnification and jurisdiction issues defined therein. Any holder of this document is advised that information contained hereon reflects the Company's findings at the time of its intervention only and within the limits of client's instruction, if any. The Company's sole responsibility is to its Client and this document does not exonerate parties to a transaction from exercising all their rights and obligations under the transaction documents. This document cannot be reproduced, except in full, without prior written approval of the Company. Any unauthorized alteration, forgery or falsification of the content or appearance of this document is unlawful and offenders may be prosecuted to the fullest extent of the law. Unless otherwise stated the results shown in this test report refer only to the sample(s) tested.

測試報告 Test Report

號碼(No.) : CE/2014/B1174

日期(Date) : 2014/11/17

頁數(Page): 13 of 15

西北臺慶科技股份有限公司 / TAI-TECH ADVANCED ELECTRONICS CO., LTD.

(臺慶精密電子(昆山)有限公司 / TAI-TECH ADVANCED ELECTRONICS (KUN-SHAN) CO. LTD.)

(耀鑽科技股份有限公司 / YOSONIC TECHNOLOGY CO., LTD.)

桃園縣楊梅市幼獅工業區幼四路1號 (NO. 1, YOU 4TH ROAD, YOUTH INDUSTRIAL DISTRICT, YANG-MEI CITY, TAO-YUAN HSIEN, TAIWAN R. O. C.)

(江蘇省昆山市蓬朗昆嘉高科技工業區郭澤路 / GUO-ZE ROAD, KUNJIA HI-TECH INDUSTRIAL PARK, KUN-SHAN, JIANG-SU, CHINA)

(桃園縣中壢市中壢工業區長春六路15號 / NO. 15, CHANGCHUN 6TH RD., JHONGLI CITY, TAOYUAN COUNTY 320, TAIWAN)



六溴環十二烷分析流程圖 / HBCDD analytical flow chart

- 測試人員：翁賜彬 / Name of the person who made measurement: Roman Wong
- 測試負責人：張啓興 / Name of the person in charge of measurement: Troy Chang

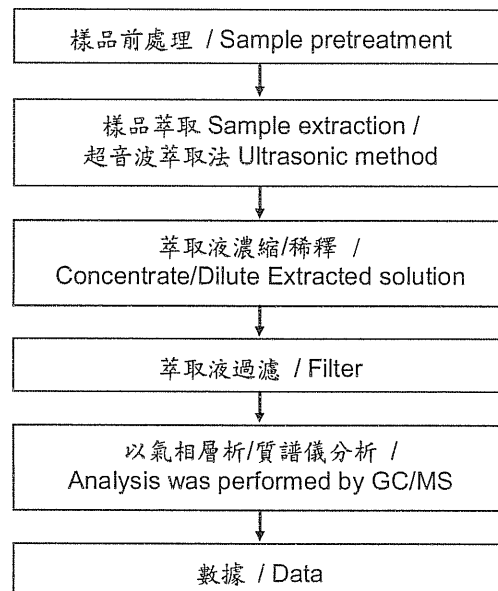

This document is issued by the Company subject to its General Conditions of Service printed overleaf, available on request or accessible at <http://www.sgs.com/en/Terms-and-Conditions.aspx> and, for electronic format documents, subject to Terms and Conditions for Electronic Documents at <http://www.sgs.com/en/Terms-and-Conditions/Termse-Documents.aspx>. Attention is drawn to the limitation of liability, indemnification and jurisdiction issues defined therein. Any holder of this document is advised that information contained hereon reflects the Company's findings at the time of its intervention only and within the limits of client's instruction, if any. The Company's sole responsibility is to its Client and this document does not exonerate parties to a transaction from exercising all their rights and obligations under the transaction documents. This document cannot be reproduced, except in full, without prior written approval of the Company. Any unauthorized alteration, forgery or falsification of the content or appearance of this document is unlawful and offenders may be prosecuted to the fullest extent of the law. Unless otherwise stated the results shown in this test report refer only to the sample(s) tested.

測試報告 Test Report

號碼(No.) : CE/2014/B1174

日期(Date) : 2014/11/17

頁數(Page): 14 of 15

西北臺慶科技股份有限公司 / TAI-TECH ADVANCED ELECTRONICS CO., LTD.

(臺慶精密電子(昆山)有限公司 / TAI-TECH ADVANCED ELECTRONICS (KUN-SHAN) CO. LTD.)

(耀鑽科技股份有限公司 / YOSONIC TECHNOLOGY CO., LTD.)

桃園縣楊梅市幼獅工業區幼四路1號 (NO. 1, YOU 4TH ROAD, YOUTH INDUSTRIAL DISTRICT, YANG-MEI CITY, TAO-YUAN HSIEN, TAIWAN R. O. C.)

(江蘇省昆山市蓬朗區嘉高科技工業區郭澤路 / GUO-ZE ROAD, KUNJIA HI-TECH INDUSTRIAL PARK, KUN-SHAN, JIANG-SU, CHINA)

(桃園縣中壢市中壢工業區長春六路15號 / NO. 15, CHANGCHUN 6TH RD., JHONGLI CITY, TAOYUAN COUNTY 320, TAIWAN)



多溴聯苯/多溴聯苯醚分析流程圖 / PBB/PBDE analytical FLOW CHART

- 測試人員：翁賜彬 / Name of the person who made measurement: Roman Wong
 - 測試負責人：張啓興 / Name of the person in charge of measurement: Troy Chang
- 初次測試程序 / First testing process —————>
- 選擇性篩檢程序 / Optional screen process>
- 確認程序 / Confirmation process - - ->

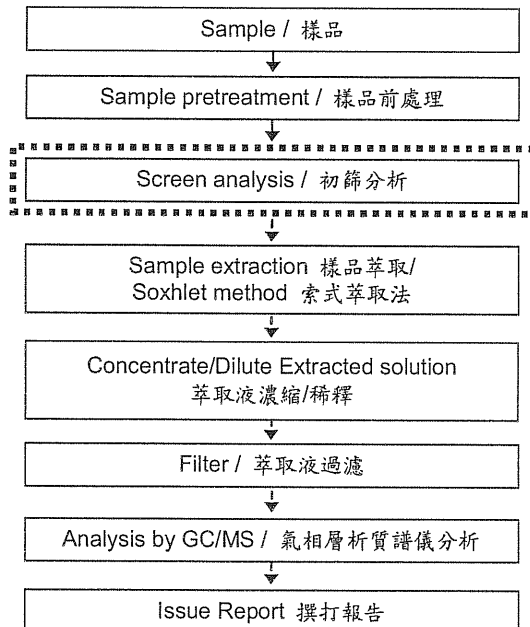

This document is issued by the Company subject to its General Conditions of Service printed overleaf, available on request or accessible at <http://www.sgs.com/en/Terms-and-Conditions.aspx> and, for electronic format documents, subject to Terms and Conditions for Electronic Documents at <http://www.sgs.com/en/Terms-and-Conditions/Termise-Documents.aspx>. Attention is drawn to the limitation of liability, indemnification and jurisdiction issues defined therein. Any holder of this document is advised that information contained hereon reflects the Company's findings at the time of its intervention only and within the limits of client's instruction, if any. The Company's sole responsibility is to its Client and this document does not exonerate parties to a transaction from exercising all their rights and obligations under the transaction documents. This document cannot be reproduced, except in full, without prior written approval of the Company. Any unauthorized alteration, forgery or falsification of the content or appearance of this document is unlawful and offenders may be prosecuted to the fullest extent of the law. Unless otherwise stated the results shown in this test report refer only to the sample(s) tested.

測試報告 Test Report

號碼(No.) : CE/2014/B1174

日期(Date) : 2014/11/17

頁數(Page): 15 of 15

西北臺慶科技股份有限公司 / TAI-TECH ADVANCED ELECTRONICS CO., LTD.

(臺慶精密電子(昆山)有限公司 / TAI-TECH ADVANCED ELECTRONICS (KUN-SHAN) CO. LTD.)

(耀鑽科技股份有限公司 / YOSONIC TECHNOLOGY CO., LTD.)

桃園縣楊梅市幼獅工業區幼四路1號 (NO. 1, YOU 4TH ROAD, YOUTH INDUSTRIAL DISTRICT, YANG-MEI CITY, TAO-YUAN HSIEN, TAIWAN R. O. C.)

(江蘇省昆山市蓬朗昆嘉高科技工業區郭澤路 / GUO-ZE ROAD, KUNJIA HI-TECH INDUSTRIAL PARK, KUN-SHAN, JIANG-SU, CHINA)

(桃園縣中壢市中壢工業區長春六路15號 / NO. 15, CHANGCHUN 6TH RD., JHONGLI CITY, TAOYUAN COUNTY 320, TAIWAN)



* 照片中如有箭頭標示，則表示為實際檢測之樣品/部位。*

(The tested sample / part is marked by an arrow if it's shown on the photo.)

CE/2014/B1174

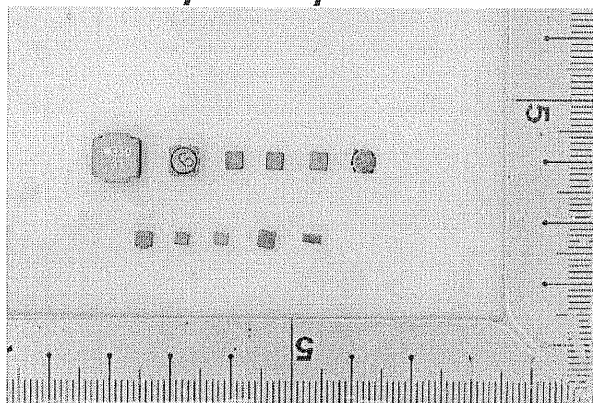

CE/2014/B1174

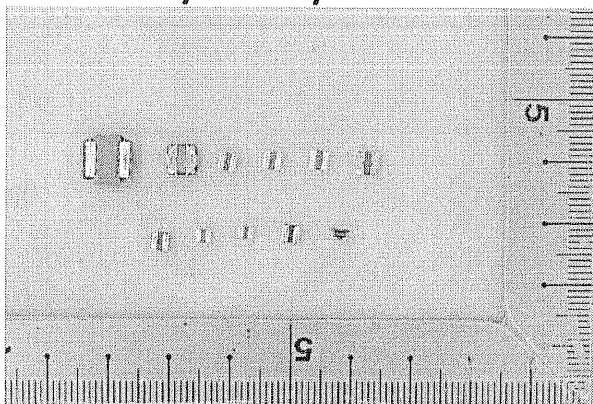

** 報告結尾 (End of Report) **

This document is issued by the Company subject to its General Conditions of Service printed overleaf, available on request or accessible at <http://www.sgs.com/en/Terms-and-Conditions.aspx> and, for electronic format documents, subject to Terms and Conditions for Electronic Documents at <http://www.sgs.com/en/Terms-and-Conditions/Termse-Documents.aspx>. Attention is drawn to the limitation of liability, indemnification and jurisdiction issues defined therein. Any holder of this document is advised that information contained hereon reflects the Company's findings at the time of its intervention only and within the limits of client's instruction, if any. The Company's sole responsibility is to its Client and this document does not exonerate parties to a transaction from exercising all their rights and obligations under the transaction documents. This document cannot be reproduced, except in full, without prior written approval of the Company. Any unauthorized alteration, forgery or falsification of the content or appearance of this document is unlawful and offenders may be prosecuted to the fullest extent of the law. Unless otherwise stated the results shown in this test report refer only to the sample(s) tested.