

■ 壓敏電阻器

ZINC OXIDE VARISTOR

是以氧化鋅為主要原料制造的半導體電子陶瓷元件，其電阻值隨施加電壓的改變而呈非線性變化，由于電阻值對電壓變化十分敏感，故稱壓敏電阻器或突波吸收器

Zinc Oxide Varistor are non-linear resistors utilizing semiconductor electronic ceramic element mainly composed of zinc oxide and its non-linear resistance change as a function of the applied voltage .It' s called Varistor or Surge absorbers.

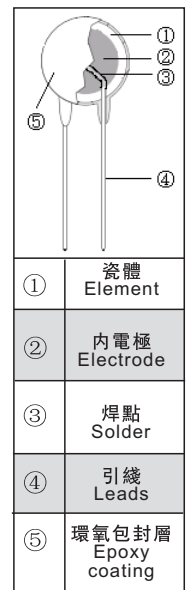

● 特性 FEATURES

- | | |
|---------------------------------|---|
| * 電壓範圍寬 (18 V~1.8 KV) | Widely voltage range 18 V~1.8 KV |
| * 反應速度快 (≤ 25 ns) | Fast response to the rapidly increase Voltage (≤ 25 ns) |
| * 非線性指數大 | Excellent non-linearity coefficient |
| * 無極性 | Symmetric V - I characteristics |
| * 通流量大(5000A/cm ²) | Great withstanding surge current (5000A/cm ²) |
| * 無續流 | No follow-on current |
| * 壽命長 | Long life |
| * 符合ROHS、REACH、無鹵環保要求 | Meet ROHS, REACH, HF requirements of environmental protection |

● 訂貨方式 HOW TO ORDER

FNR	10	K	471	B	A	S	E	1	NN
商標 trademark	允許誤差 Tolerance K ± 10%	標稱壓敏電壓(V) Nominal Varistor Voltage 820=82 × 10 ⁰ 471=47 × 10 ¹ 102=10 × 10 ²	包裝方式 Packaging B 散包裝 Bulk T 編帶 Tape	引腳腳型 Lead Type A 直腳 Straight B 外彎腳 Outward Crimp F 內彎腳 Inward Crimp Y Y型腳 Y-crimp V 側彎腳 Lateral Crimp L L型腳 L-crimp	引腳長度/孔距 Lead Length /Pitch row S 不切腳 Non- cutting C 切腳 Cutting T 編帶孔距 12.7mm Pitch-row 12.7mm V 編帶孔距 15.0mm Pitch-row 15.0mm	產品等級 Product level N 常規 Normal Energy E 高能 High Energy A 汽車等級 Automotive class	產品配置 product configurative 1 常規 conventional 2 透明套管 Lucency Jacket 3 黑色套管 Blackt Jacket M 立式防爆 Vertical Explosion -proof W 卧式防爆 Horizontal Explosion -proof	內部控制 代碼 Internal Control Code	

瓷片直徑 Element Diameter	
05	5mm
07	7mm
10	10mm
14	14mm
20	20mm

● 特性曲綫 CHARACTERISTIC CURVE

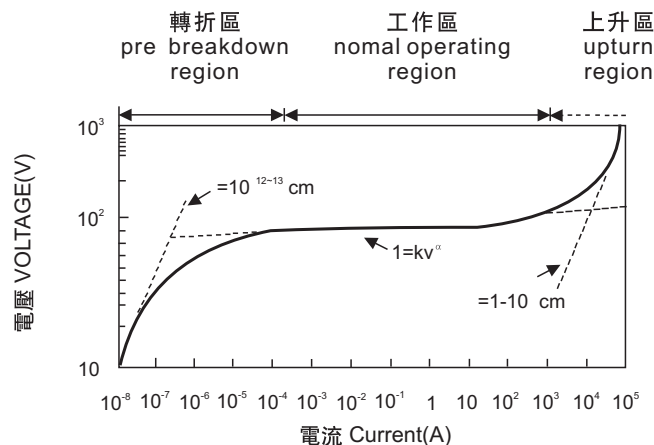

Voltage Current Characteristic

壓敏電阻器 ZINC OXIDE VARISTOR

● 包裝方式及數量 (參考) PACKAGING & QUANTITY (Reference)

規格 Code	數量 Quantity		
	散裝 Bluk / 塑料袋 Plastic bag		編帶 Tape/盒裝 Paper Box
	長脚 Long	短脚 Trimmed	
05K	1000PCS	1000/2000PCS	1500 / 2000PCS
07K	1000PCS	1500PCS	1500 / 2000PCS
10K	500 / 1000PCS	500PCS	700/800 / 1000PCS
14K	250 / 500PCS	500PCS	600 / 800 / 1000PCS
20K	200 / 250PCS	400PCS	300/600PCS
25K	20/100PCS		
32K	20PCS		
40K	20PCS		

● 結構尺寸 DIMENSION

散裝產品 BULK SPECIFICATION

單位 (Unit) : mm

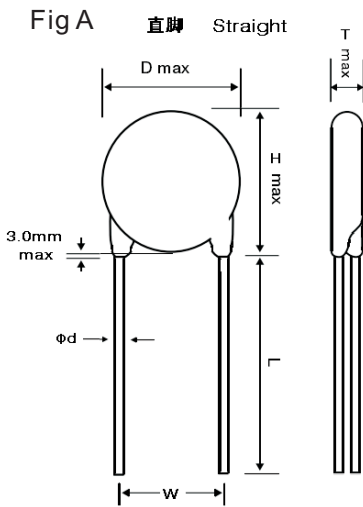

規格 Part Code	D	H		d	W	L	
	MAX	直脚 Straight MAX	彎脚 Crimp MAX	± 0.05	± 1.0	不切脚 Non-cutting MIN	切脚 Cutting ± 1.0
05K	7.5	9.0	10.0	0.6	5.0	10.0	3.5
07K	9.0	12.0	14.0	0.6	5.0	10.0	3.5
10K	12.5	16.0	18.0	0.8	7.5	10.0	3.5
14K	17.0	19.0	22.0	0.8	7.5	10.0	3.5
20K	23.0	26.0	28.0	1.0	10.0	10.0	--
25K	28.0	33.0	--	1.5	15.0	10.0	--
32K	35.0	40.0	--	1.5	18.0	10.0	--
40K	44.0	50.0	--	1.5	18.0	10.0	--

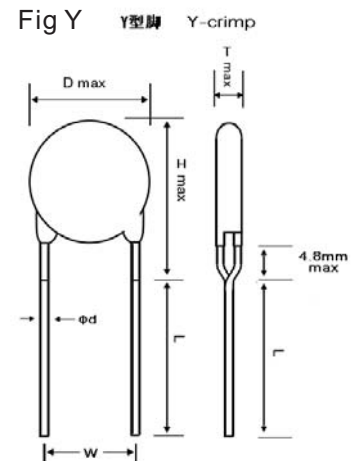
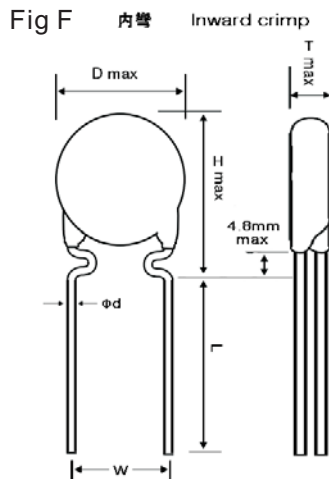
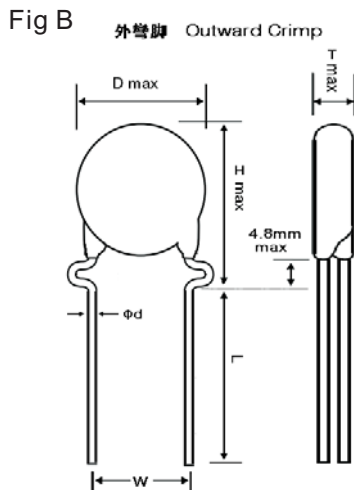

● 產品厚度 Thickness (max) (單位Unit:mm)

規格 Part Code	05k	07k	10k	14k	20k	25k	32k	40k
180	3.4	3.6	4.0	4.1	4.5			
220	3.5	3.8	4.1	4.3	4.6			
270	3.8	4.0	4.3	4.5	4.8			
330	3.5	3.7	4.1	4.5	5.0			
390	3.7	3.9	4.3	4.4	4.7			
470	3.8	4.1	4.5	4.6	4.9			
560	3.8	4.2	4.5	4.7	5.0			
680	4.0	4.3	4.5	4.5	5.0			
820	3.3	3.5	3.8	4.0	4.3			
101	3.6	3.8	4.2	4.3	4.6			
121	3.8	4.0	4.4	4.5	4.6			
151	4.1	4.3	4.7	4.8	5.1			
181	3.6	3.6	4.3	4.5	4.6			
201	3.7	3.7	4.4	4.6	4.8	5.4	5.6	5.6
221	3.8	3.8	4.5	4.7	4.9	5.5	5.7	5.7
241	4.0	4.0	4.7	4.9	5.0	5.6	5.8	5.8
271	4.1	4.1	4.8	5.0	5.2	5.8	6.0	6.0
301	4.3	4.3	5.0	5.2	5.4	5.9	6.1	6.1
331	4.5	4.5	5.2	5.4	5.6	6.1	6.3	6.3
361	4.6	4.6	5.3	5.5	5.9	6.4	6.6	6.6
391	4.9	4.9	5.6	5.8	6.0	6.6	6.8	6.8
431	5.1	5.1	5.7	5.9	6.1	6.9	7.1	7.1
471	5.4	5.4	6.1	6.3	6.5	7.2	7.4	7.4
511	5.6	5.6	6.3	6.5	6.7	7.2	7.4	7.4
561	5.9	5.9	6.6	6.8	6.9	7.2	7.9	7.9
621		6.2	6.9	7.1	7.3	8.0	8.2	8.2
681		6.7	7.3	7.5	7.7	8.0	8.2	8.2
751			7.7	7.9	8.0	8.4	8.6	8.6
781			7.8	8.0	8.2	8.5	8.7	8.7
821			8.1	8.3	8.5	8.7	8.9	8.9
911			8.7	8.9	9.1	9.2	9.4	9.4
102			8.1	8.3	8.5	9.7	9.9	9.9
112			8.6	8.8	9.0	10.3	10.5	10.5
182			12.8	12.8	13.0	13.0	13.2	13.5

壓敏電阻器
ZINC OXIDE VARISTOR

● 編帶產品 TAPING SPECIFICATION

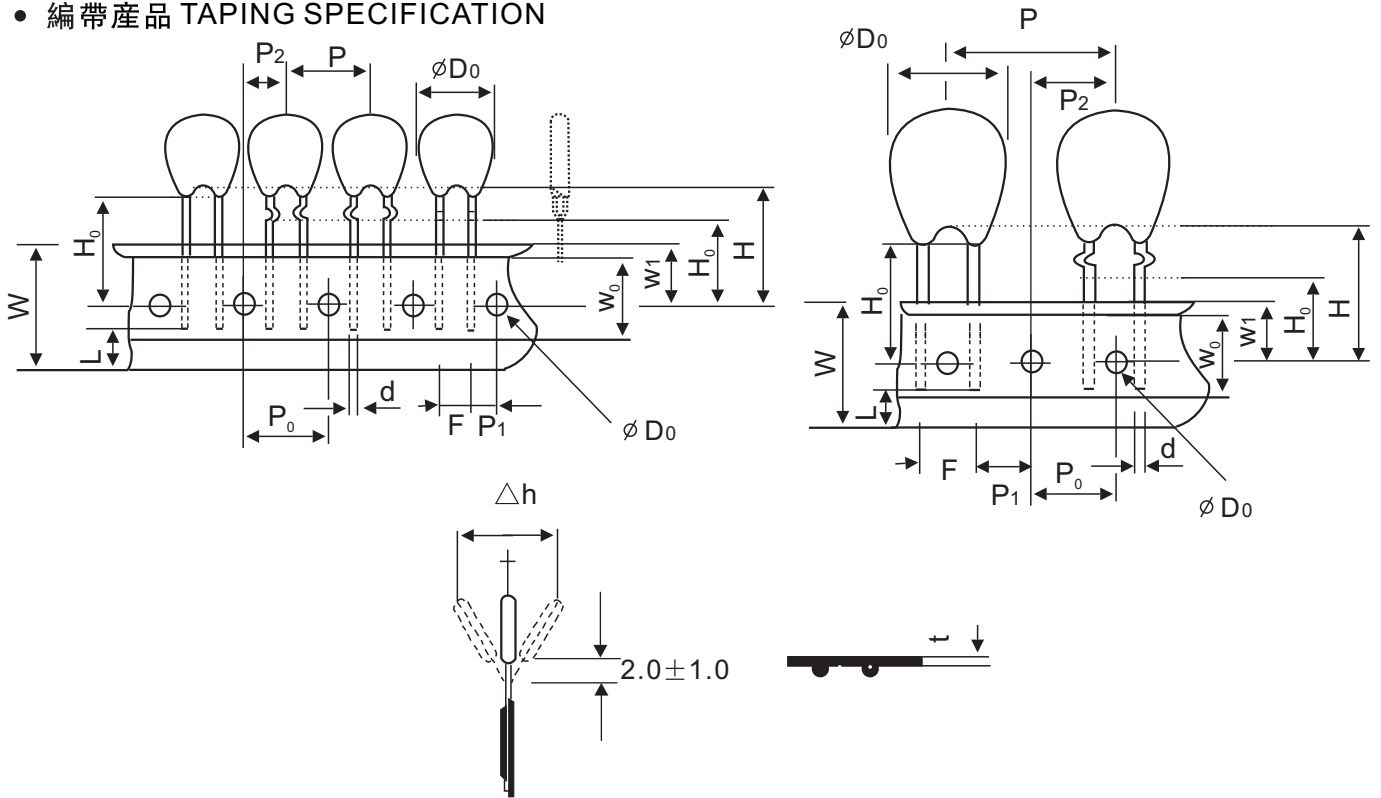

單位:毫米 Unit:mm

Series Symbol	05K	07K	10K		14K		20K
∅ D	7.0 Max	9.0 Max	12.5 Max	12.5 Max	17.0 Max	17.0 Max	22.0 Max
∅ d	0.6±0.05	0.6±0.05	0.8±0.05	0.8±0.05	0.8±0.05	0.8±0.05	1.0±0.05
P	12.7±1.0	12.7±1.0	25.4±1.0	15.0±1.0	25.4±1.0	30.0±1.0	25.4±1.0
P ₀	12.7±1.0	12.7±1.0	12.7±1.0	15.0±1.0	12.7±1.0	15.0±1.0	12.7±1.0
P ₁	3.85±0.70	3.85±0.70	8.95±0.70	3.85±0.70	8.95±0.70	11.15±0.70	7.5±0.70
P ₂	6.35±1.30	6.35±1.30	12.7±1.30	7.5±1.30	12.7±1.30	15.0±1.30	12.7±1.30
∅D ₀	4.0±0.2	4.0±0.2	4.0±0.2	4.0±0.2	4.0±0.2	4.0±0.2	4.0±0.2
W	18±1.0	18±1.0	18±1.0	18±1.0	18±1.0	18±1.0	18±1.0
W ₀	12.5 Min	12.5 Min	12.5 Min	12.5 Min	12.5 Min	12.5 Min	12.5 Min
W ₁	9.0±1.0	9.0±1.0	9.0±1.0	9.0±1.0	9.0±1.0	9.0±1.0	9.0±1.0
W ₂	3.0 Max	3.0 Max	3.0 Max	3.0 Max	3.0 Max	3.0 Max	3.0 Max
H	20.0 Max	20.0 Max	20.0 Max	20.0 Max	20.0 Max	20.0 Max	20.0 Max
H ₀	16.0±1.0	16.0±1.0	16.0±1.0	16.0±1.0	16.0±1.0	16.0±1.0	16.0±1.0
Δh	0±2.0	0±2.0	0±2.0	0±2.0	0±2.0	0±2.0	0±2.0
t	0.6±0.3	0.6±0.3	0.6±0.3	0.6±0.3	0.6±0.3	0.6±0.3	0.6±0.3
L	9.0±1.0	9.0±1.0	9.0±1.0	9.0±1.0	9.0±1.0	9.0±1.0	9.0±1.0
F	5.0±1.0	5.0±1.0	7.5±1.0	7.5±1.0	7.5±1.0	7.5±1.0	10.0±1.0

● 安規認證 AGENCY APPROVALS

認證機構 Agency	UL & CUL	VDE	CQC
認證檔案號 #File Number	E325462	40008242	05K: CQC14001111451
			07K: CQC14001111447
			10K: CQC14001111568
			14K: CQC14001111589
			20K: CQC14001111567

● 電性能參數 ELECTRICAL CHARACTERISTICS

● 05K系列電性能 05K SERIES SPECIFICATION

型號規格 Part Number	最大允許 使用電壓 Maximum operating Voltage		壓敏電壓 Varistor Voltage V0.1mA (V)	最大限制電壓 Maximum clamping Voltage		最大通流容量 Maximum Withstanding Surge Current (8 / 20 μ s) 1 Times(A)	最大能量耐量 Maximum Energy (2ms) (J)	額定功率 Rated Wattage (W)	靜態電容量 (參考值) (1K Hz) Capacitance (Reference) (PF)
	AC (V)	DC (V)		Vc (V)	IP (A)				
FNR-05K180	11	14	18 (16.2~19.8)	40	1	100	0.4	0.01	1600
FNR-05K220	14	18	22 (19.8~24.2)	48	1	100	0.5	0.01	1300
FNR-05K270	17	22	27 (24.3~29.7)	60	1	100	0.6	0.01	1050
FNR-05K330	20	26	33 (29.7~36.3)	73	1	100	0.8	0.01	900
FNR-05K390	25	31	39 (35.1~42.9)	86	1	100	0.9	0.01	500
FNR-05K470	30	38	47 (42.3~51.7)	104	1	100	1.1	0.01	450
FNR-05K560	35	45	56 (50.4~61.6)	123	1	100	1.3	0.01	400
FNR-05K680	40	56	68 (61.2~74.8)	150	1	100	1.6	0.01	350
FNR-05K820	50	65	82 (73.8~90.2)	155	5	400	1.8	0.1	250
FNR-05K101	60	85	100 (90~110)	175	5	400	2.2	0.1	200
FNR-05K121	75	100	120 (108~132)	210	5	400	2.5	0.1	170
FNR-05K151	95	125	150 (135~165)	260	5	400	4.0	0.1	140
FNR-05K181	115	150	180 (162~198)	315	5	400	4.5	0.1	110
FNR-05K201	130	170	200 (180~220)	355	5	400	5.0	0.1	80
FNR-05K221	140	180	220 (198~242)	380	5	400	6.0	0.1	70
FNR-05K241	150	200	240 (216~264)	415	5	400	6.5	0.1	70
FNR-05K271	175	225	270 (243~297)	475	5	400	8.0	0.1	65
FNR-05K301	195	250	300 (270~330)	525	5	400	8.0	0.1	55
FNR-05K331	210	275	330 (297~363)	580	5	400	8.5	0.1	60
FNR-05K361	230	300	360 (324~396)	620	5	400	10.0	0.1	50
FNR-05K391	250	320	390 (351~429)	675	5	400	10.0	0.1	50
FNR-05K431	275	350	430 (387~473)	745	5	400	12.0	0.1	45
FNR-05K471	300	385	470 (423~517)	810	5	400	13.0	0.1	40
FNR-05K511	320	410	510 (459~561)	845	5	400	14.0	0.1	39
FNR-05K561	350	460	560 (504~616)	920	5	400	14.0	0.1	39

壓敏電阻器 ZINC OXIDE VARISTOR

● 05K系列 Series

V-I Curve

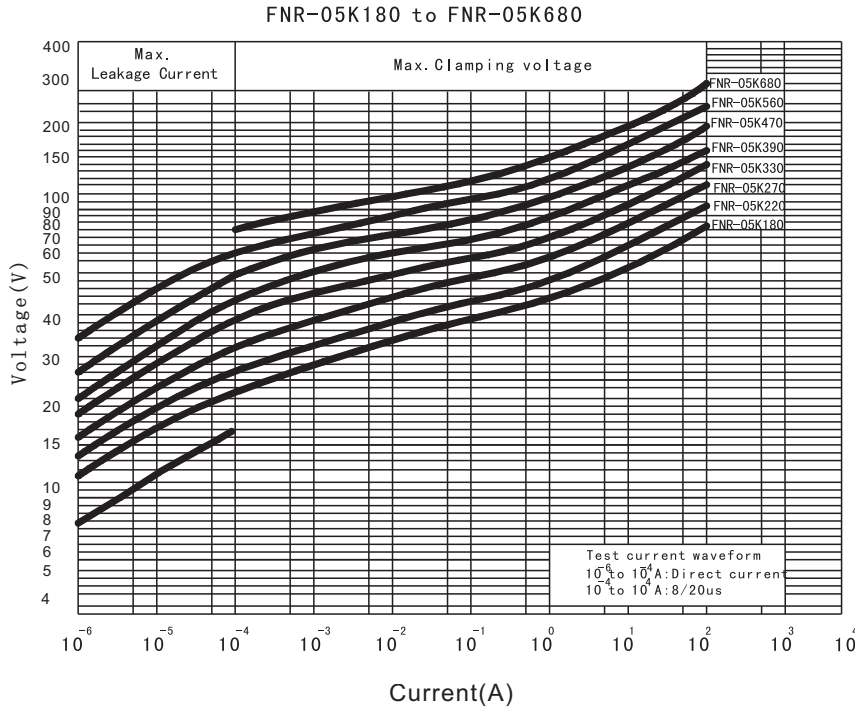

Impulse Lifetime Ratings
 (2 time:5 minutes internal
 up to 10 times 2 minutes internal
 up to 10^5 times 10 seconds internal)

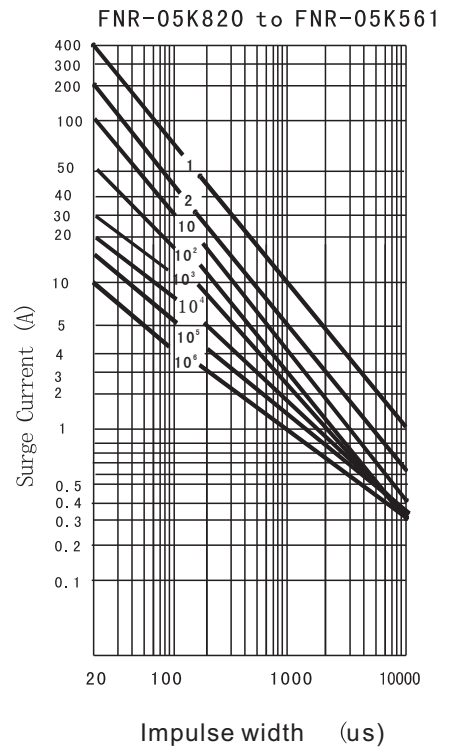
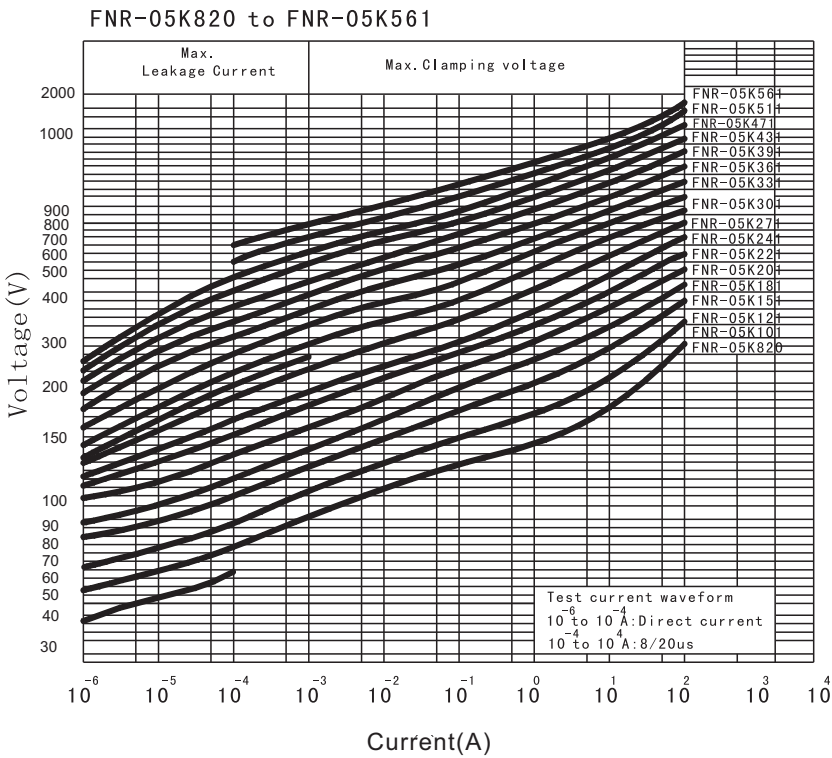
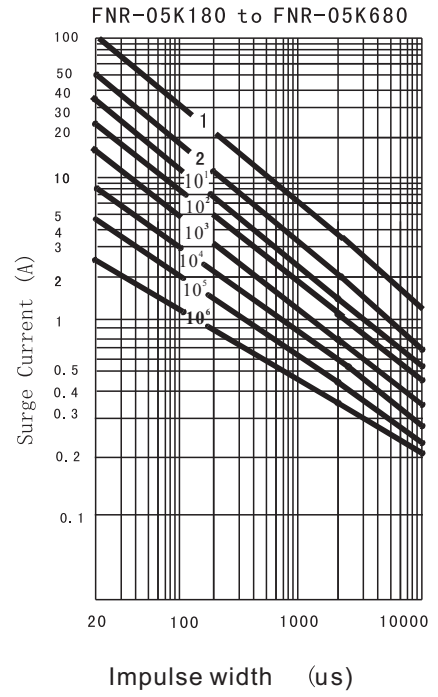

● 07K系列電性能 07K SERIES SPECIFICATION

型號規格 Part Number	最大允許 使用電壓 Maximum operating Voltage		壓敏電壓 Varistor Voltage	最大限制電壓 Maximum clamping Voltage		最大通流容量 Maximum Withstanding Surge Current (8/20 μ S)		最大能量耐量 Maximum Energy				額定功率 Rated Wattage	靜態電容量 (參考值) (1K Hz) Capacitance (Reference)
	AC (V)	DC (V)		V1mA (V)	Vc (V)			IP (A)	1 Times(A)		(J)		
			常規			高能	常規		高能				
							2ms		$10 \frac{\mu\text{A}}{\mu\text{S}}$	2ms	$10 \frac{\mu\text{A}}{\mu\text{S}}$		
FNR-07K180	11	14	18(16.2~19.8)	36	2.5	250		0.9	1.3			0.02	3500
FNR-07K220	14	18	22(19.8~24.2)	43	2.5	250		1.1	1.5			0.02	2800
FNR-07K270	17	22	27(24.3~29.7)	53	2.5	250		1.4	2.0			0.02	2000
FNR-07K330	20	26	33(29.7~36.3)	65	2.5	250		1.7	2.4			0.02	1500
FNR-07K390	25	31	39(35.1~42.9)	77	2.5	250		2.1	2.9			0.02	1350
FNR-07K470	30	38	47(42.3~51.7)	93	2.5	250		2.5	3.5			0.02	1150
FNR-07K560	35	45	56(50.4~61.6)	110	2.5	250		3.1	4.3			0.02	950
FNR-07K680	40	56	68(61.2~74.8)	135	2.5	250		3.6	5.0			0.02	700
FNR-07K820	50	65	82(73.8~90.2)	135	10	1200		4.2	5.5			0.25	550
FNR-07K101	60	85	100(90~110)	165	10	1200		4.8	6.5			0.25	500
FNR-07K121	75	100	120(108~132)	200	10	1200		5.9	7.8			0.25	450
FNR-07K151	95	125	150(135~165)	250	10	1200		8.0	9.7			0.25	350
FNR-07K181	115	150	180(162~198)	300	10	1200	1800	10.0	11.7	13.0	19.0	0.25	300
FNR-07K201	130	170	200(180~220)	340	10	1200	1800	13.0	14.0	15.0	21.0	0.25	250
FNR-07K221	140	180	220(198~242)	360	10	1200	1800	13.0	14.0	16.4	23.0	0.25	250
FNR-07K241	150	200	240(216~264)	395	10	1200	1800	13.0	14.0	17.8	25.0	0.25	200
FNR-07K271	175	225	270(243~297)	455	10	1200	1800	15.0	18.0	20.0	28.0	0.25	170
FNR-07K301	195	250	300(270~330)	500	10	1200	1800	17.0	21.0	22.8	32.0	0.25	150
FNR-07K331	210	275	330(297~363)	550	10	1200	1800	22.0	25.0	24.2	34.0	0.25	150
FNR-07K361	230	300	360(324~396)	595	10	1200	1800	22.0	25.0	26.4	37.0	0.25	130
FNR-07K391	250	320	390(351~429)	650	10	1200	1800	22.0	25.0	28.6	40.0	0.25	130
FNR-07K431	275	350	430(387~473)	710	10	1200	1800	26.0	28.0	32.8	46.0	0.25	110
FNR-07K471	300	385	470(423~517)	775	10	1200	1800	26.0	30.0	35.0	49.0	0.25	100
FNR-07K511	320	410	510(459~561)	840	10	1200	1800	26.0	33.0	38.5	54.0	0.25	100
FNR-07K561	350	460	560(504~616)	925	10	1200	1800	26.0	33.0	29.2	55.0	0.25	90
FNR-07K621	385	505	620(558~682)	1025	10	1200	1800	28.0	35.0	42.0	59.0	0.25	80
FNR-07K681	420	560	680(612~748)	1120	10	1200	1800	28.0	35.0	44.3	62.0	0.25	75

● 07K系列 07K Series

V-I Curve

Impulse Lifetime Ratings
(2 time:5 minutes internal
up to 10 times 2 minutes internal
up to 10⁶ times 10 seconds internal)

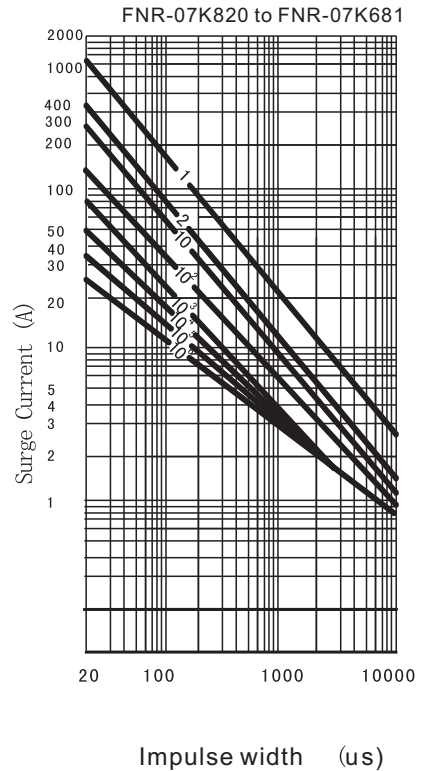
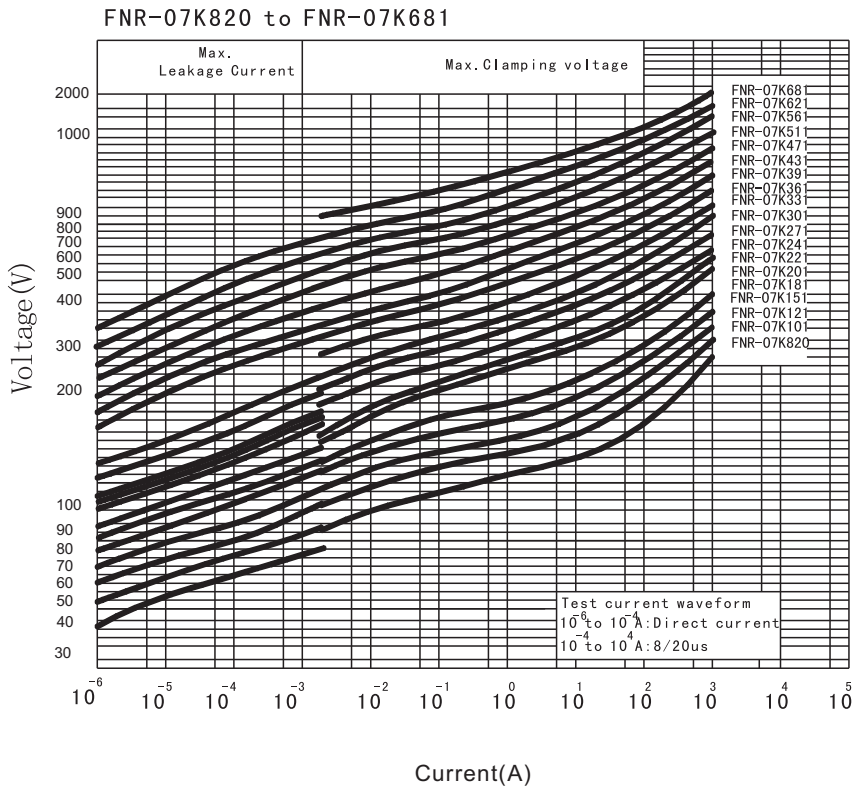
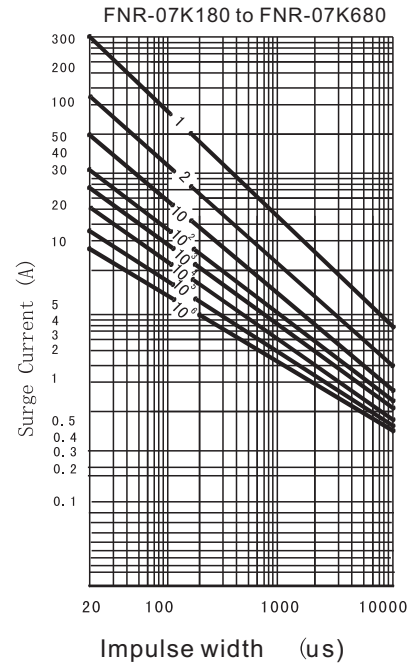
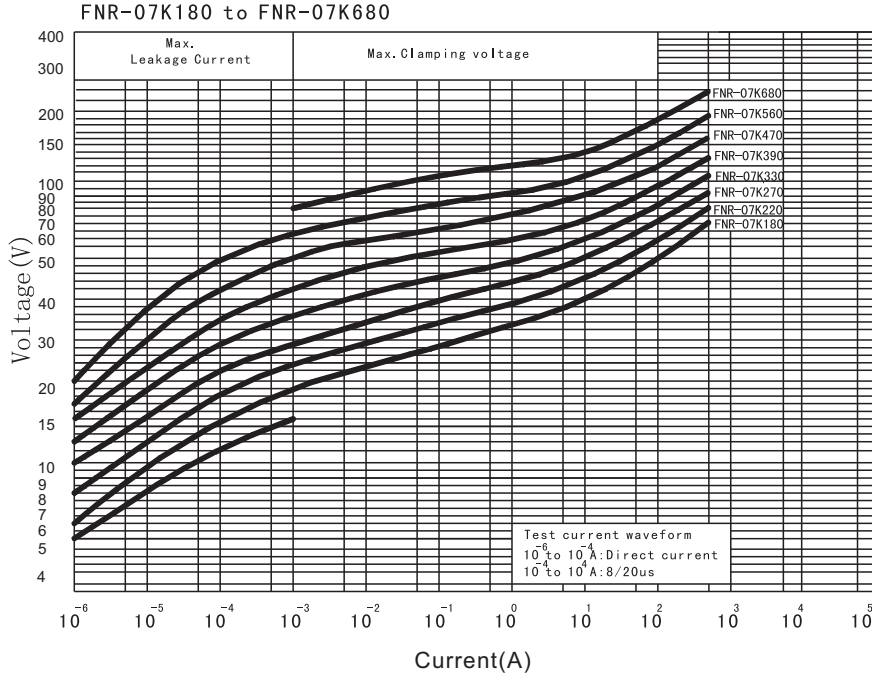

● 10K系列電性能 10K SERIES SPECIFICATION

型號規格 Part Number	最大允許 使用電壓 Maximum operating Voltage		壓敏電壓 Varistor Voltage	最大限制電壓 Maximum clamping Voltage		最大通流容量 Maximum Withstanding Surge Current (8/20 μ S)		最大能量耐量 Maximum Energy				額定功率 Rated Wattage	靜態電容量 (參考值) (1k Hz) Capacitance (Reference)
	AC (V)	DC (V)		V1mA (V)	Vc (V)			IP (A)	1 Times (A)		(J)		
			常規			高能	常規		高能				
				2ms	$10^4/1000$ μ s		2ms	$10^4/1000$ μ s					
FNR-10K180	11	14	18(16.2~19.8)	36	5	500		2.1	2.9			0.05	7500
FNR-10K220	14	18	22(19.8~24.2)	43	5	500		2.5	3.5			0.05	6000
FNR-10K270	17	22	27(24.3~29.7)	53	5	500		3.0	4.2			0.05	4000
FNR-10K330	20	26	33(29.7~36.3)	65	5	500		4.0	5.6			0.05	3000
FNR-10K390	25	31	39(35.1~42.9)	77	5	500		4.6	6.4			0.05	2600
FNR-10K470	30	38	47(42.3~51.7)	93	5	500		5.5	7.7			0.05	2200
FNR-10K560	35	45	56(50.4~61.6)	110	5	500		7.0	9.8			0.05	1800
FNR-10K680	40	56	68(61.2~74.8)	135	5	500		8.2	11			0.05	1300
FNR-10K820	50	65	82(73.8~90.2)	135	25	2500		8.4	12			0.4	1800
FNR-10K101	60	85	100(90~110)	165	25	2500		10	15			0.4	1400
FNR-10K121	75	100	120(108~132)	200	25	2500		15	18			0.4	1100
FNR-10K151	95	125	150(135~165)	250	25	2500		20	22			0.4	900
FNR-10K181	115	150	180(162~198)	300	25	2500	3500	23	27	27	33	0.4	700
FNR-10K201	130	170	200(180~220)	340	25	2500	3500	26	30	30	35	0.4	500
FNR-10K221	140	180	220(198~242)	360	25	2500	3500	30	32	32	39	0.4	450
FNR-10K241	150	200	240(216~264)	395	25	2500	3500	32	35	35	42	0.4	400
FNR-10K271	175	225	270(243~297)	455	25	2500	3500	35	40	41	49	0.4	350
FNR-10K301	195	250	300(270~330)	500	25	2500	3500	35	40	45	53	0.4	325
FNR-10K331	210	275	330(297~363)	550	25	2500	3500	39	43	49	58	0.4	325
FNR-10K361	230	300	360(324~396)	595	25	2500	3500	45	47	53	65	0.4	300
FNR-10K391	250	320	390(351~429)	650	25	2500	3500	52	60	58	70	0.4	270
FNR-10K431	275	350	430(387~473)	710	25	2500	3500	55	65	63	80	0.4	250
FNR-10K471	300	385	470(423~517)	775	25	2500	3500	58	70	69	85	0.4	230
FNR-10K511	320	410	510(459~561)	840	25	2500	3500	58	70	69	92	0.4	200
FNR-10K561	350	455	560(504~616)	925	25	2500	3500	58	70	69	92	0.4	180
FNR-10K621	385	505	620(558~682)	1025	25	2500	3500	58	70	69	95	0.4	130
FNR-10K681	420	560	680(612~748)	1120	25	2500	3500	60	72	74	98	0.4	130
FNR-10K751	460	615	750(675~825)	1240	25	2500	3500	65	75	81	100	0.4	120
FNR-10K781	485	640	780(702~858)	1290	25	2500	3500	65	75	85	100	0.4	120
FNR-10K821	510	670	820(738~902)	1355	25	2500	3500	71	85	99	110	0.4	110
FNR-10K911	550	745	910(819~1001)	1500	25	2500	3500	78	93	109	130	0.4	100
FNR-10K102	625	825	1000(900~1100)	1650	25	2500	3500	84	102	117	140	0.4	90
FNR-10K112	680	895	1100(990~1210)	1815	25	2500	3500	91	115	127	155	0.4	80
FNR-10K182	1000	1465	1800 (1620~1980)	2970	25	2500	3500	132	185	182	255	0.4	80

壓敏電阻器 ZINC OXIDE VARISTOR

• 10K系列 10K Series

V-I Curve

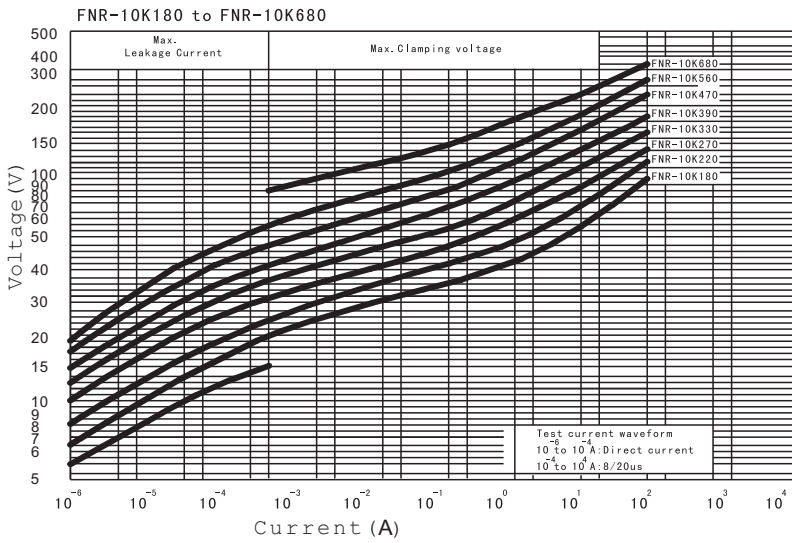

Impluse Lifetime Ratings

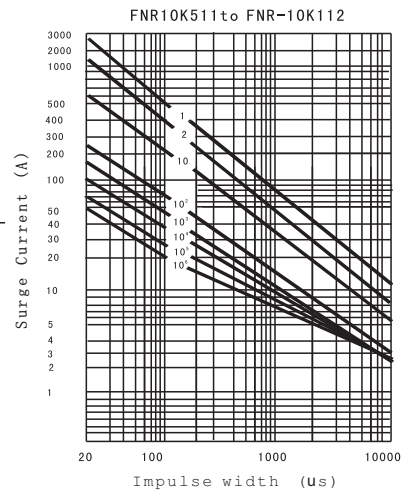
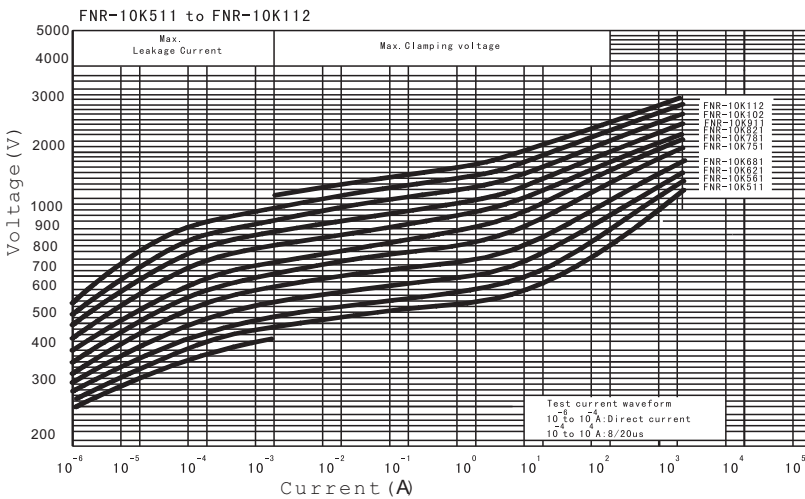
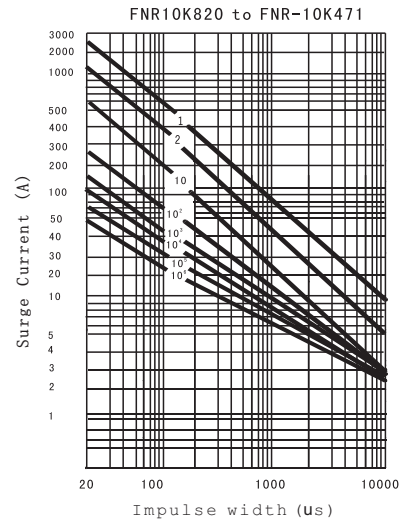
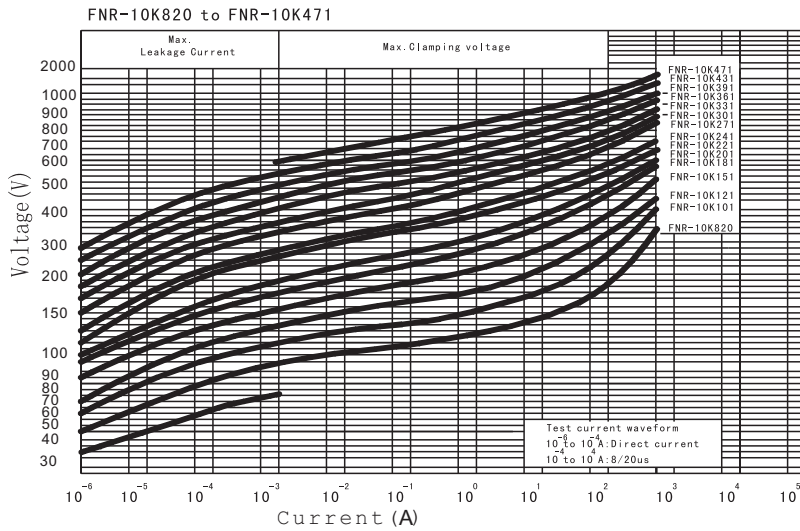
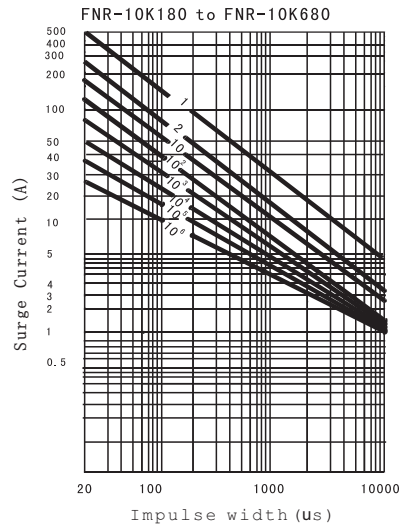

● 14K系列電性能 14K SERIES SPECIFICATION

型號規格 Part Number	最大允許 使用電壓 Maximum operating Voltage		壓敏電壓 Varistor Voltage	最大限制電壓 Maximum clamping Voltage		最大通流容量 Maximum Withstanding Surge Current (8/20 μ S)	最大能量耐量 Maximum Energy				額定功率 Rated Wattage	靜態電容量 (參考值) (1K Hz) Capacitance (Reference)	
	AC (V)	DC (V)		V1mA (V)	Vc (V)		IP (A)	1 Times (A)		(J)			
			常規			高能		常規		高能			
	2ms	$10^4/1000$ μs		2ms	$10^4/1000$ μs								
FNR-14K180	11	14	18(16.2~19.8)	36	10	1000		4.0	5.0			0.1	18000
FNR-14K220	14	18	22(19.8~24.2)	43	10	1000		5.0	6.0			0.1	15000
FNR-14K270	17	22	27(24.3~29.7)	53	10	1000		6.0	7.0			0.1	10000
FNR-14K330	20	26	33(29.7~36.3)	65	10	1000		7.5	8.5			0.1	7500
FNR-14K390	25	31	39(35.1~42.9)	77	10	1000		8.6	10			0.1	6500
FNR-14K470	30	38	47(42.3~51.7)	93	10	1000		10	12			0.1	5500
FNR-14K560	35	45	56(50.4~61.6)	110	10	1000		11	14			0.1	4500
FNR-14K680	40	56	68(61.2~74.8)	135	10	1000		14	18			0.1	3300
FNR-14K820	50	65	82(73.8~90.2)	135	50	4500		15	22			0.6	2900
FNR-14K101	60	85	100(90~110)	165	50	4500		18	28			0.6	2400
FNR-14K121	75	100	120(108~132)	200	50	4500		26	32			0.6	1900
FNR-14K151	95	125	150(135~165)	250	50	4500		32	40			0.6	1500
FNR-14K181	115	150	180(162~198)	300	50	4500	6000	39	52	54	60	0.6	1250
FNR-14K201	130	170	200(180~220)	340	50	4500	6000	45	57	61	84	0.6	1000
FNR-14K221	140	180	220(198~242)	360	50	4500	6000	52	63	65	91	0.6	1000
FNR-14K241	150	200	240(216~264)	395	50	4500	6000	52	63	71	98	0.6	900
FNR-14K271	175	225	270(243~297)	455	50	4500	6000	65	70	81	112	0.6	750
FNR-14K301	195	250	300(270~330)	500	50	4500	6000	71	78	90	123	0.6	650
FNR-14K331	210	275	330(297~363)	550	50	4500	6000	78	85	99	133	0.6	650
FNR-14K361	230	300	360(324~396)	595	50	4500	6000	84	93	107	147	0.6	550
FNR-14K391	250	320	390(351~429)	650	50	4500	6000	91	100	117	161	0.6	500
FNR-14K431	275	350	430(387~473)	710	50	4500	6000	97	115	127	182	0.6	450
FNR-14K471	300	385	470(423~517)	775	50	4500	6000	104	125	140	196	0.6	440
FNR-14K511	320	410	510(459~561)	840	50	4500	6000	104	125	150	210	0.6	380
FNR-14K561	350	455	560(504~616)	925	50	4500	6000	104	125	165	231	0.6	345
FNR-14K621	385	505	620(558~682)	1025	50	4500	6000	110	130	180	252	0.6	250
FNR-14K681	420	560	680(612~748)	1120	50	4500	6000	117	136	190	266	0.6	250
FNR-14K751	460	615	750(675~825)	1240	50	4500	6000	130	143	200	280	0.6	230
FNR-14K781	485	640	780(702~858)	1290	50	4500	6000	136	150	200	280	0.6	230
FNR-14K821	510	670	820(738~902)	1355	50	4500	6000	143	157	203	285	0.6	200
FNR-14K911	550	745	910(819~1001)	1500	50	4500	6000	156	175	220	308	0.6	180
FNR-14K102	625	825	1000(900~1100)	1650	50	4500	6000	169	190	240	336	0.6	150
FNR-14K112	680	895	1100(990~1210)	1815	50	4500	6000	182	213	260	364	0.6	150
FNR-14K182	1000	1465	1800 (1620~1980)	2970	50	4500	6000	312	354	356	510	0.6	100

壓敏電阻器 ZINC OXIDE VARISTOR

• 14K系列 14K Series

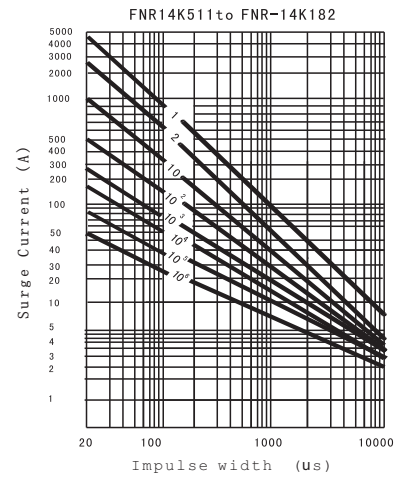
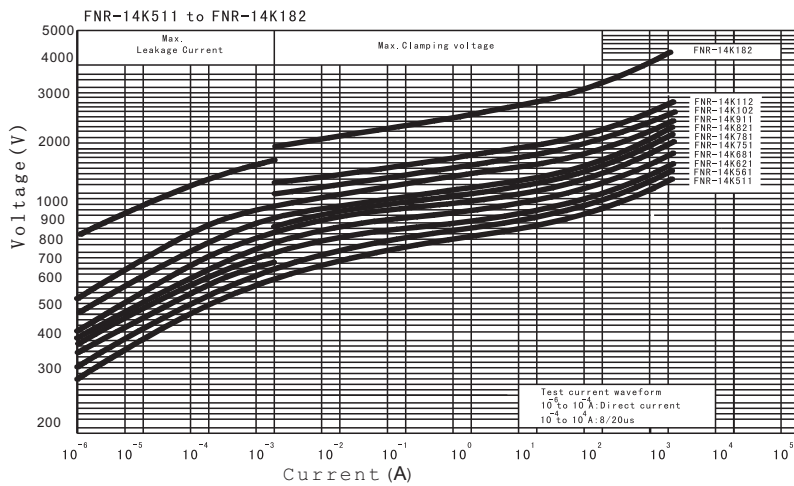
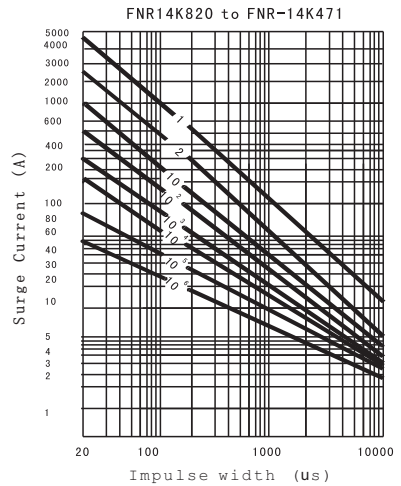
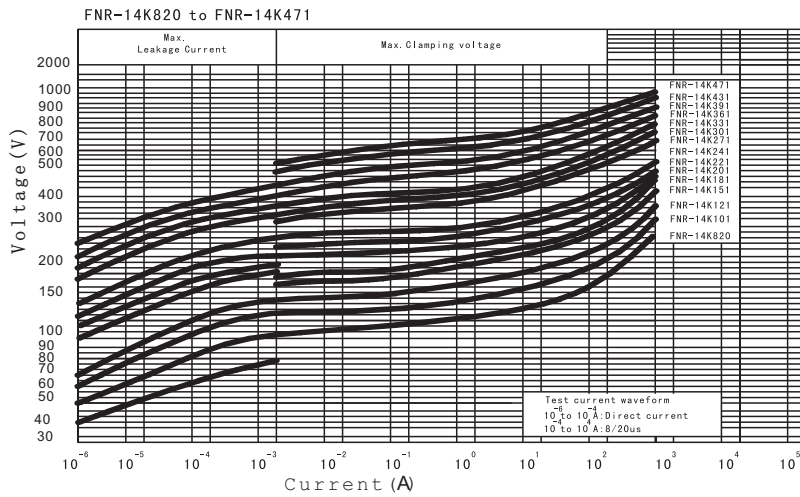
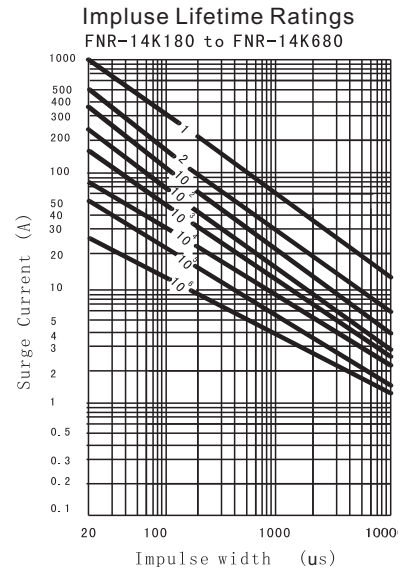
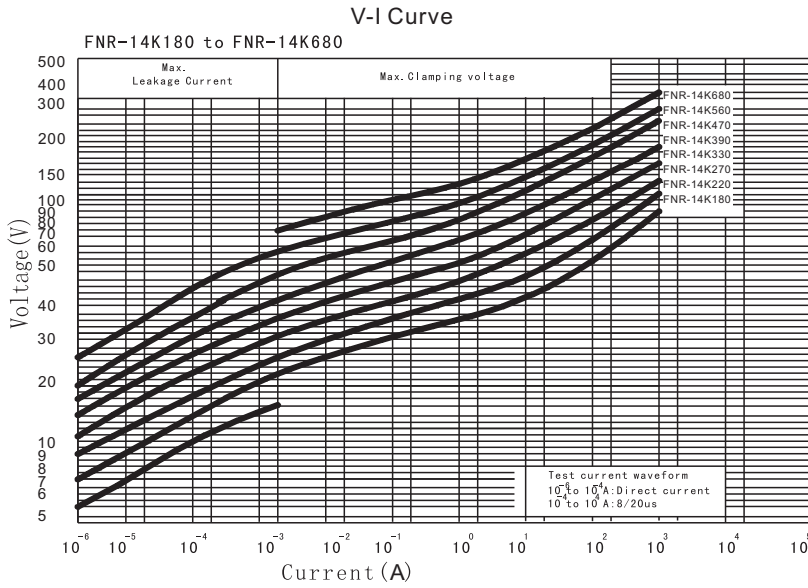

● 20K系列電性能 20K SERIES SPECIFICATION

型號規格 Part Number	最大允許 使用電壓 Maximun operating Voltage		壓敏電壓 Varistor Voltage	最大限制電壓 Maximun clamping Voltage		最大通流容量 Maximum Withstanding Surge Current (8/20 μ S)		最大能量耐量 Maximum Energy				額定功率 Rated Wattage	靜態電容量 (參考值) (1K Hz) Capacitance (Reference)
	AC (V)	DC (V)		V1mA (V)	Vc (V)	IP (A)	1 Times (A)		(J)				
			常規				高能	常規		高能			
				2ms	$10^{1/1000}$ μs	2ms		$10^{1/1000}$ μs					
FNR-20K180	11	14	18(16.2~19.8)	36	20	2000		10	11			0.2	18000
FNR-20K220	14	18	22(19.8~24.2)	43	20	2000		13	14			0.2	30000
FNR-20K270	17	22	27(24.3~29.7)	53	20	2000		15	18			0.2	20000
FNR-20K330	20	26	33(29.7~36.3)	65	20	2000		18	23			0.2	17000
FNR-20K390	25	31	39(35.1~42.9)	77	20	2000		20	26			0.2	15000
FNR-20K470	30	38	47(42.3~51.7)	93	20	2000		25	33			0.2	13000
FNR-20K560	35	45	56(50.4~61.6)	110	20	2000		30	41			0.2	11000
FNR-20K680	40	56	68(61.2~74.8)	135	20	2000		33	46			0.2	7000
FNR-20K820	50	65	82(73.8~90.2)	135	100	6500		38	48			1.0	5500
FNR-20K101	60	85	100(90~110)	165	100	6500		42	51			1.0	4800
FNR-20K121	75	100	120(108~132)	200	100	6500		52	55			1.0	3800
FNR-20K151	95	125	150(135~165)	250	100	6500		65	70			1.0	3000
FNR-20K181	115	150	180(162~198)	300	100	6500	10000	78	84	90	126	1.0	2500
FNR-20K201	130	170	200(180~220)	340	100	6500	10000	91	95	102	142	1.0	2000
FNR-20K221	140	180	220(198~242)	360	100	6500	10000	97	100	108	151	1.0	2000
FNR-20K241	150	200	240(216~264)	395	100	6500	10000	100	108	118	165	1.0	1800
FNR-20K271	175	225	270(243~297)	455	100	6500	10000	117	127	136	191	1.0	1600
FNR-20K301	195	250	300(270~330)	500	100	6500	10000	136	150	150	210	1.0	1400
FNR-20K331	210	275	330(297~363)	550	100	6500	10000	136	150	165	231	1.0	1400
FNR-20K361	230	300	360(324~396)	595	100	6500	10000	156	163	178	249	1.0	1200
FNR-20K391	250	320	390(351~429)	650	100	6500	10000	169	180	195	273	1.0	1000
FNR-20K431	275	350	430(387~473)	710	100	6500	10000	182	190	213	298	1.0	900
FNR-20K471	300	385	470(423~517)	775	100	6500	10000	195	220	232	325	1.0	900
FNR-20K511	320	410	510(459~561)	840	100	6500	10000	195	220	232	325	1.0	800
FNR-20K561	350	455	560(504~616)	925	100	6500	10000	195	220	232	325	1.0	700
FNR-20K621	385	505	620(558~682)	1025	100	6500	10000	195	220	246	344	1.0	500
FNR-20K681	420	560	680(612~748)	1120	100	6500	10000	208	230	268	376	1.0	460
FNR-20K751	460	615	750(675~825)	1240	100	6500	10000	227	255	297	416	1.0	420
FNR-20K781	485	640	780(702~858)	1290	100	6500	10000	234	265	309	433	1.0	420
FNR-20K821	510	670	820(738~902)	1355	100	6500	10000	247	282	325	455	1.0	400
FNR-20K911	550	745	910(819~1001)	1500	100	6500	10000	280	310	360	504	1.0	350
FNR-20K102	625	825	1000(900~1100)	1650	100	6500	10000	299	340	396	554	1.0	320
FNR-20K112	680	895	1100(990~1210)	1815	100	6500	10000	325	383	435	609	1.0	300
FNR-20K182	1000	1465	1800 (1620~1980)	2970	100	6500	10000	400	620	707	990	1.0	200

壓敏電阻器 ZINC OXIDE VARISTOR

• 20K系列 20K Series

V-I Curve

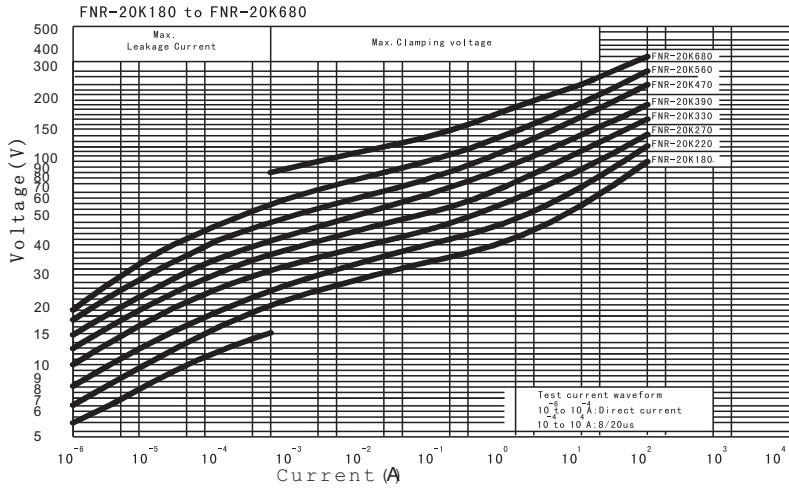

Impluse Lifetime Ratings

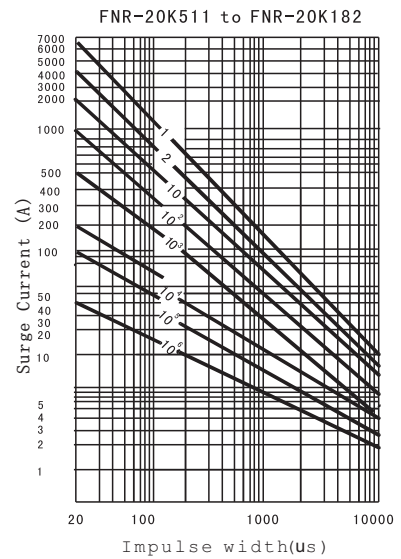
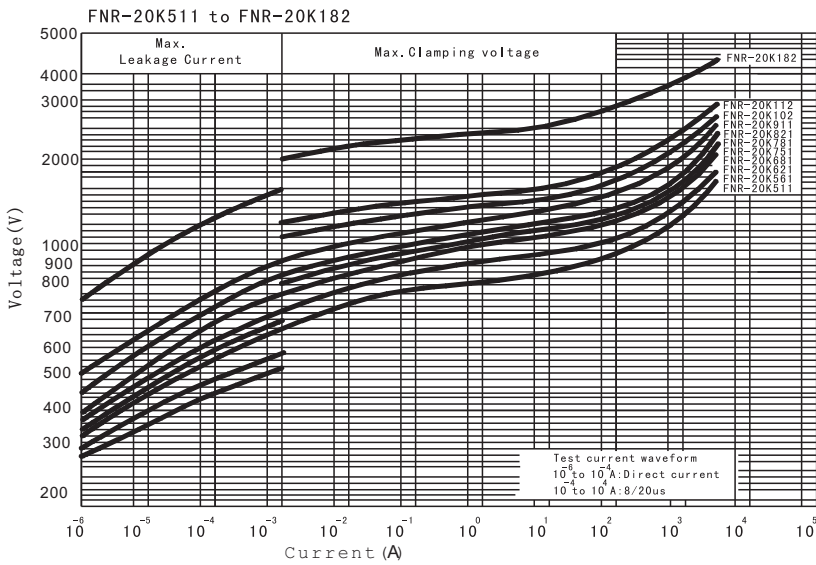
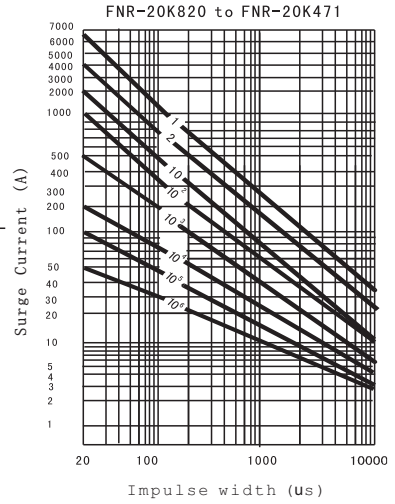
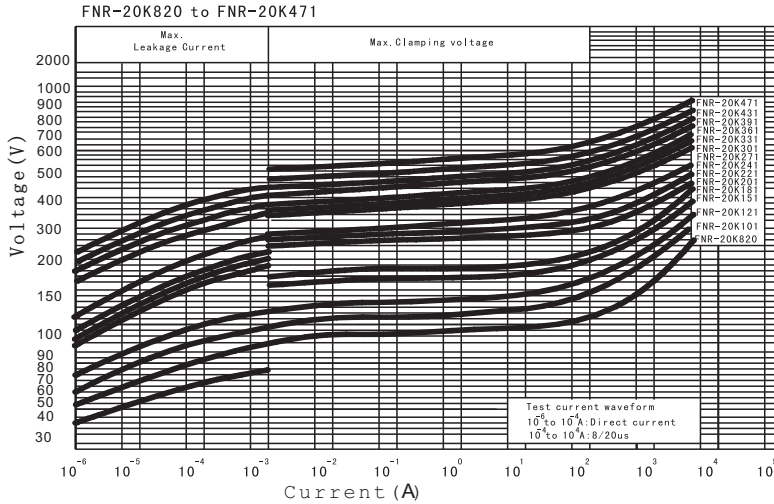
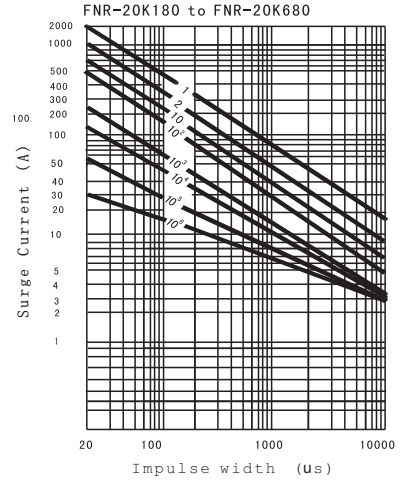

● 25K系列電性能 25K SERIES SPECIFICATION

型號規格 Part Number	最大允許 使用電壓 Maximum operating Voltage		壓敏電壓 Varistor Voltage	最大限制電壓 Maximum clamping Voltage		最大通流量 Maximum Withstanding Surge Current (8/20 μ S)	最大能量耐量 Maximum Energy (2ms)	額定功率 Rated Wattage	靜態電容量 (參考值) (1K Hz) Capacitance (Reference)
	AC (V)	DC (V)	V1mA (V)	Vc (V)	IP (A)	1 Times (A)	(J)	(W)	(PF)
FNR-25K470	30	38	47(42.3~51.7)	93	40	2500	15	1.0	15000
FNR-25K560	35	45	56(50.4~61.6)	110	40	2500	21	1.0	13000
FNR-25K680	40	56	68(61.2~74.8)	135	40	2500	23	1.0	10000
FNR-25K820	50	65	82(73.8~90.2)	156	150	20000	35	1.0	8500
FNR-25K101	60	85	100(90~110)	175	150	20000	32	1.0	7000
FNR-25K121	75	100	120(108~132)	210	150	20000	36	1.0	6000
FNR-25K151	95	125	150(135~165)	270	150	20000	39	1.0	5000
FNR-25K201	130	170	200(180~220)	360	150	20000	45	1.0	3400
FNR-25K221	140	180	220(198~242)	385	150	20000	52	1.0	3200
FNR-25K241	150	200	240(216~264)	420	150	20000	78	1.0	3000
FNR-25K271	175	225	270(243~297)	473	150	20000	117	1.0	2200
FNR-25K301	195	250	300(270~330)	500	150	20000	130	1.0	2000
FNR-25K331	210	275	330(297~363)	550	150	20000	140	1.0	2000
FNR-25K361	230	300	360(324~396)	595	150	20000	156	1.0	1900
FNR-25K391	250	320	390(351~429)	650	150	20000	195	1.0	1800
FNR-25K431	275	350	430(387~473)	710	150	20000	234	1.0	1500
FNR-25K471	300	385	470(423~517)	775	150	20000	286	1.0	1500
FNR-25K511	320	410	510(459~561)	840	150	20000	290	1.0	1400
FNR-25K561	350	455	560(504~616)	925	150	20000	300	1.0	1350
FNR-25K621	380	505	620(558~682)	1025	150	20000	338	1.0	1300
FNR-25K681	420	560	680(612~748)	1120	150	20000	390	1.0	1250
FNR-25K751	460	615	750(675~825)	1240	150	20000	455	1.0	1200
FNR-25K781	485	640	780(702~858)	1290	150	20000	481	1.0	1200
FNR-25K821	510	670	820(738~902)	1355	150	20000	520	1.0	1100
FNR-25K911	550	745	910(819~1001)	1500	150	20000	546	1.0	1000
FNR-25K102	625	825	1000(900~1100)	1650	150	20000	585	1.0	800
FNR-25K112	680	895	1100(990~1210)	1815	150	20000	650	1.0	700
FNR-25K182	1000	1465	1800(1620~1980)	2970	150	20000	700	1.0	600

壓敏電阻器 ZINC OXIDE VARISTOR

• 25K系列 25K Series

V-I Curve

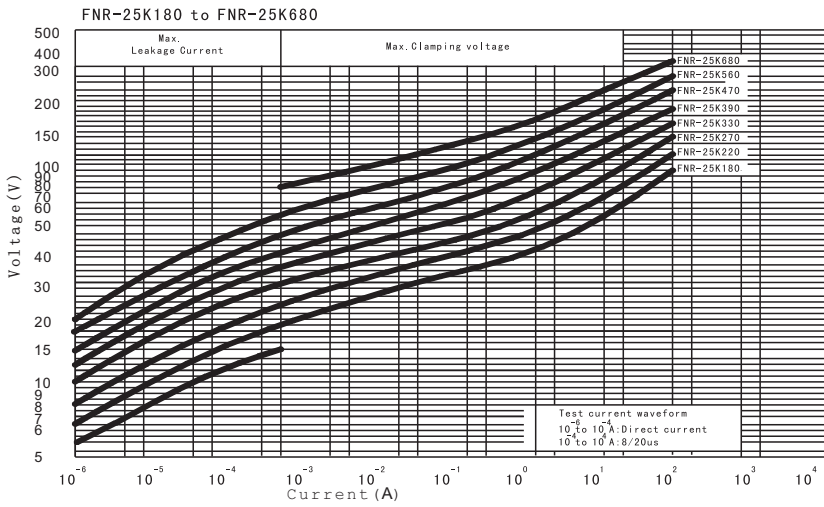

Impulse Lifetime Ratings

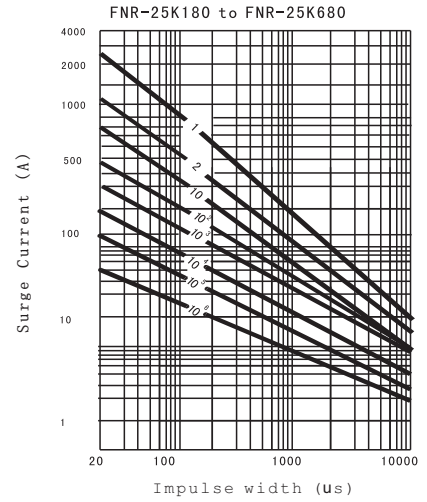

FNR-25K820 to FNR-25K471

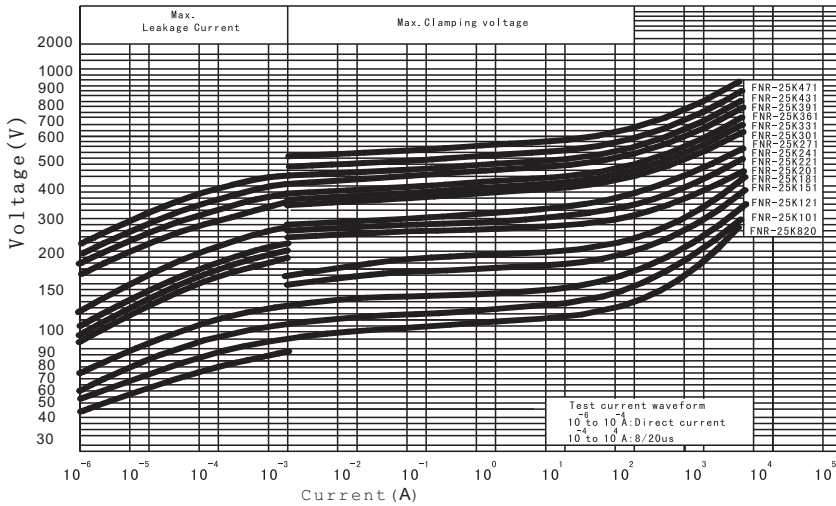

FNR-25K820 to FNR-25K471

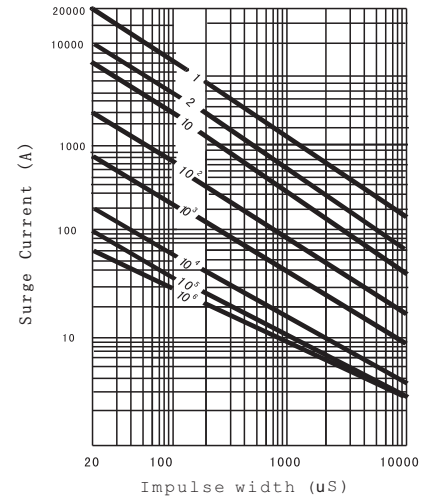

FNR-25K511 to FNR-25K182

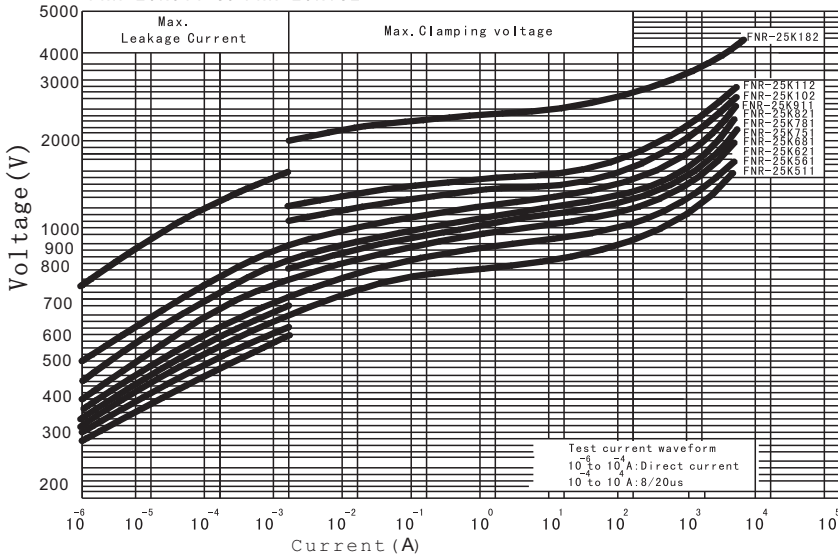

FNR-25K511 to FNR-25K182

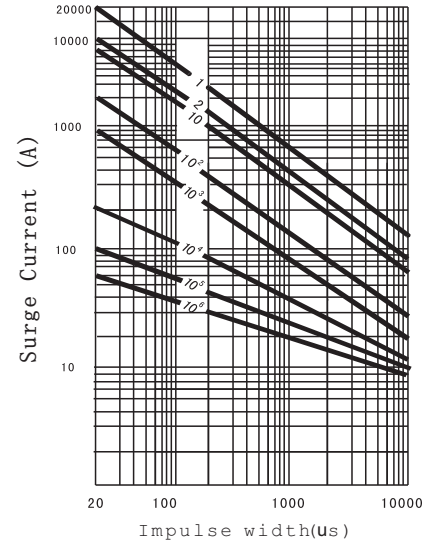

● 32K系列電性能 32K SERIES SPECIFICATION

型號規格 Part Number	最大允許 使用電壓 Maximum operating Voltage		壓敏電壓 Varistor Voltage	最大限制電壓 Maximum clamping Voltage		最大通流容量 Maximum Withstanding Surge Current (8/20 μ S)	最大能量耐量 Maximum Energy (2ms)	額定功率 Rated Wattage	靜態電容量 (參考值) (1K Hz) Capacitance (Reference)
	AC (V)	DC (V)		V1mA (V)	VC (V)				
FNR-32K470	30	38	47(42.3~51.7)	89	40	5000	25	1.2	27000
FNR-32K560	35	45	56(50.4~61.6)	106	40	5000	30	1.2	23000
FNR-32K680	40	56	68(61.2~74.8)	129	40	5000	32	1.2	18000
FNR-32K820	50	65	82(73.8~90.2)	156	200	30000	35	1.2	15000
FNR-32K101	60	85	100(90~110)	190	200	30000	49	1.2	13000
FNR-32K121	75	100	120(108~132)	216	200	30000	54	1.2	10000
FNR-32K151	95	125	150(135~165)	270	200	30000	65	1.2	9000
FNR-32K201	130	170	200(180~220)	360	200	30000	91	1.2	5500
FNR-32K221	140	180	220(198~242)	385	200	30000	117	1.2	5200
FNR-32K241	150	200	240(216~264)	395	200	30000	156	1.2	5000
FNR-32K271	175	225	270(243~297)	455	200	30000	195	1.2	4200
FNR-32K301	195	250	300(270~330)	500	200	30000	200	1.2	4000
FNR-32K331	210	275	330(297~363)	550	200	30000	210	1.2	4000
FNR-32K361	230	300	360(324~396)	595	200	30000	234	1.2	3500
FNR-32K391	250	320	390(351~429)	650	200	30000	286	1.2	3000
FNR-32K431	275	350	430(387~473)	710	200	30000	338	1.2	2500
FNR-32K471	300	385	470(423~517)	775	200	30000	390	1.2	2500
FNR-32K511	320	410	510(459~561)	840	200	30000	400	1.2	2400
FNR-32K561	350	455	560(504~616)	925	200	30000	410	1.2	2300
FNR-32K621	385	505	620(558~682)	1025	200	30000	442	1.2	2200
FNR-32K681	420	560	680(612~748)	1120	200	30000	492	1.2	2100
FNR-32K751	460	615	750(675~825)	1240	200	30000	559	1.2	2000
FNR-32K781	485	640	780(702~858)	1290	200	30000	624	1.2	1900
FNR-32K821	510	670	820(738~902)	1355	200	30000	689	1.2	1800
FNR-32K911	550	745	910(819~1001)	1500	200	30000	754	1.2	1700
FNR-32K102	625	825	1000(900~1100)	1650	200	30000	819	1.2	1000
FNR-32K112	680	895	1100(990~1210)	1815	200	30000	910	1.2	1000
FNR-32K182	1000	1465	1800(1620~1980)	2970	200	30000	920	1.2	800

● 32K系列 32K Series

V-I Curve

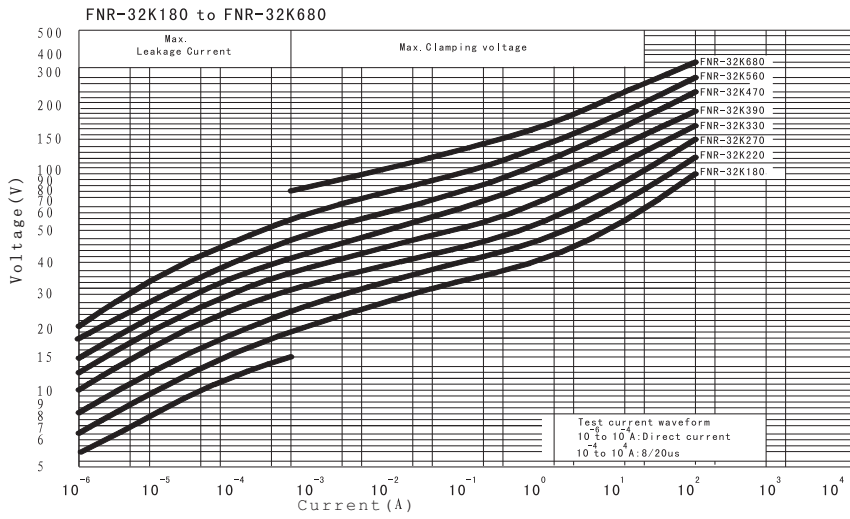

Impluse Lifetime Ratings
FNR-32K180 to FNR-32K680

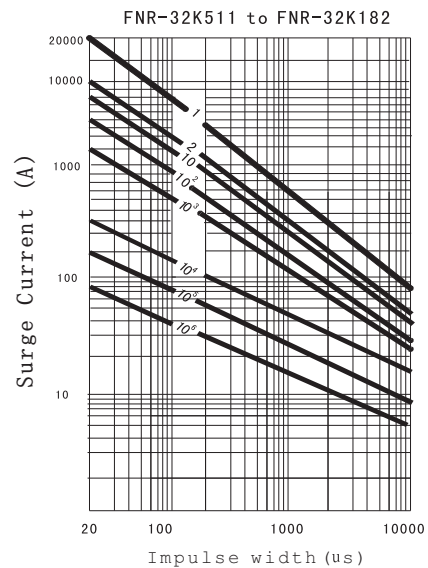
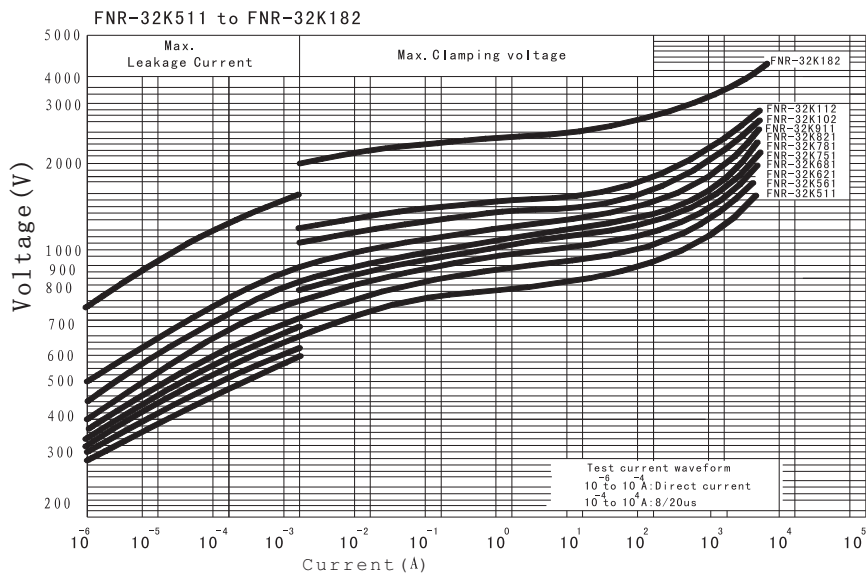
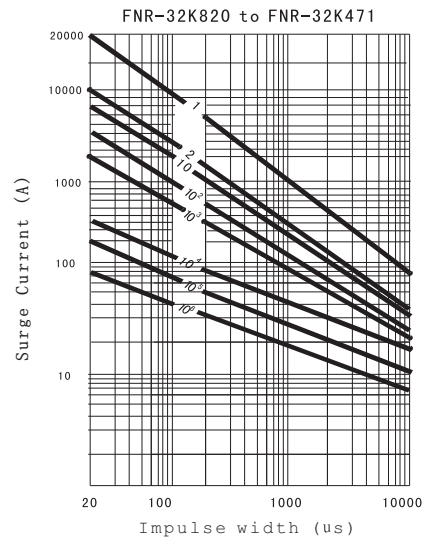
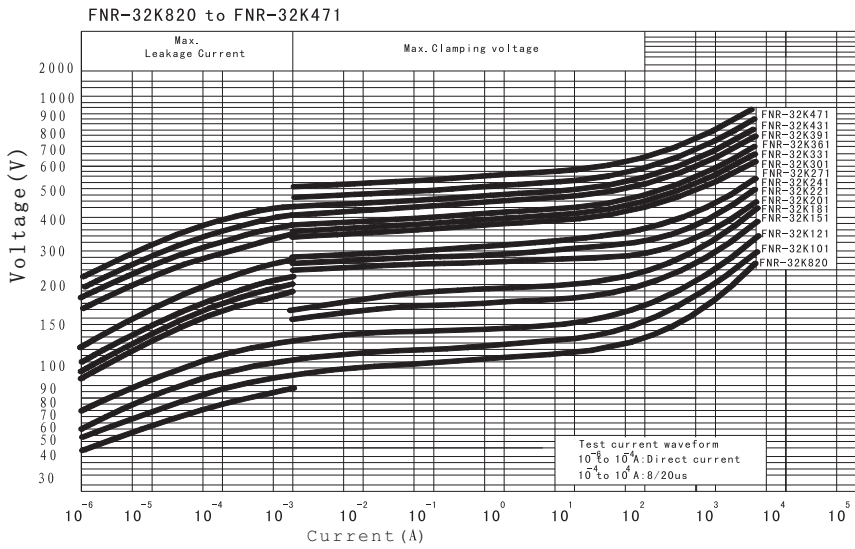
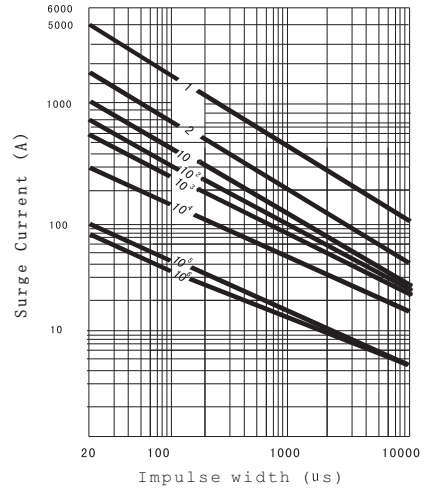

● 40K系列電性能 40K SERIES SPECIFICATION

型號規格 Part Number	最大允許 使用電壓 Maximum operating Voltage		壓敏電壓 Varistor Voltage	最大限制電壓 Maximum clamping Voltage		最大通流容量 Maximum Withstanding Surge Current (8/20 μ S)	最大能量耐量 Maximum Energy (2ms)	額定功率 Rated Wattage	靜態電容量 (參考值) 1K Hz Capacitance (Reference)
	AC (V)	DC (V)		V1mA (V)	V _C (V)				
FNR-40K201	130	170	200(180~220)	360	250	40000	208	1.4	10000
FNR-40K221	140	180	220(198~242)	385	250	40000	234	1.4	9500
FNR-40K241	150	200	240(216~264)	395	250	40000	286	1.4	9000
FNR-40K271	175	225	270(243~297)	455	250	40000	308	1.4	8000
FNR-40K301	195	250	300(270~330)	500	250	40000	320	1.4	7000
FNR-40K331	210	275	330(297~363)	550	250	40000	330	1.4	6500
FNR-40K361	230	300	360(324~396)	595	250	40000	390	1.4	6000
FNR-40K391	250	320	390(351~429)	650	250	40000	442	1.4	5000
FNR-40K431	275	350	430(387~473)	710	250	40000	494	1.4	4500
FNR-40K471	300	385	470(423~517)	775	250	40000	546	1.4	4000
FNR-40K511	320	410	510(459~561)	840	250	40000	585	1.4	3800
FNR-40K561	350	455	560(504~616)	925	250	40000	585	1.4	3700
FNR-40K621	385	505	620(558~682)	1025	250	40000	585	1.4	3400
FNR-40K681	420	560	680(612~748)	1120	250	40000	650	1.4	3000
FNR-40K751	460	615	750(675~825)	1240	250	40000	715	1.4	2700
FNR-40K781	485	640	780(702~858)	1290	250	40000	780	1.4	2500
FNR-40K821	510	670	820(738~902)	1355	250	40000	832	1.4	2500
FNR-40K911	550	745	910(819~1001)	1500	250	40000	910	1.4	2250
FNR-40K102	625	825	1000(900~1100)	1650	250	40000	1040	1.4	2000
FNR-40K112	680	895	1100(990~1210)	1815	250	40000	1105	1.4	1800
FNR-40K182	1000	1465	1800(1620~1980)	2970	250	40000	1300	1.4	1600

壓敏電阻器 ZINC OXIDE VARISTOR

● 40K系列 40K Series

V-I Curve

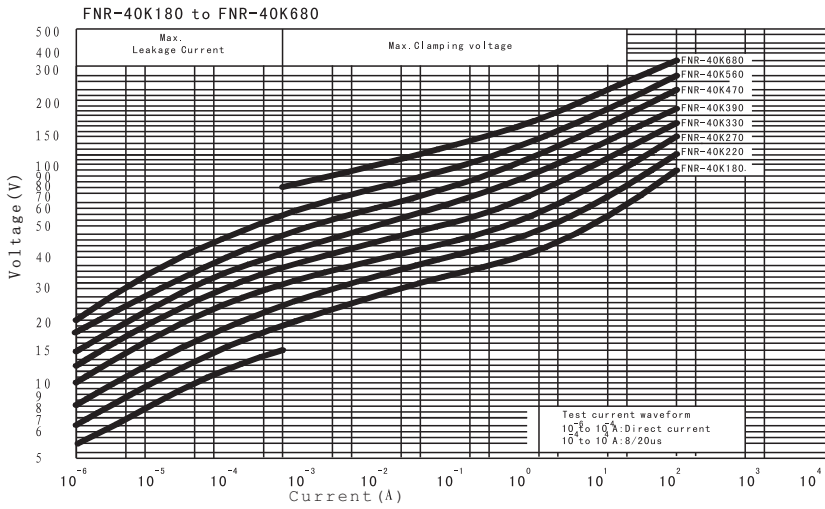

Impulse Lifetime Ratings
FNR-40K180 to FNR-40K680

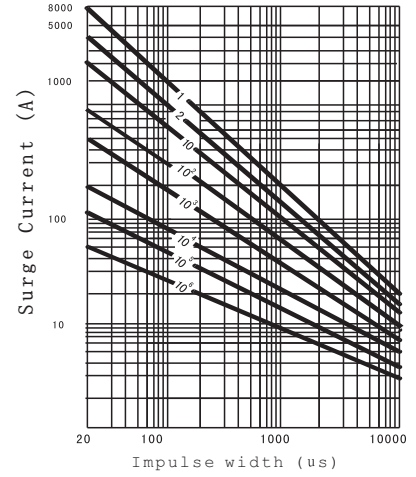

FNR-40K820 to FNR-40K471

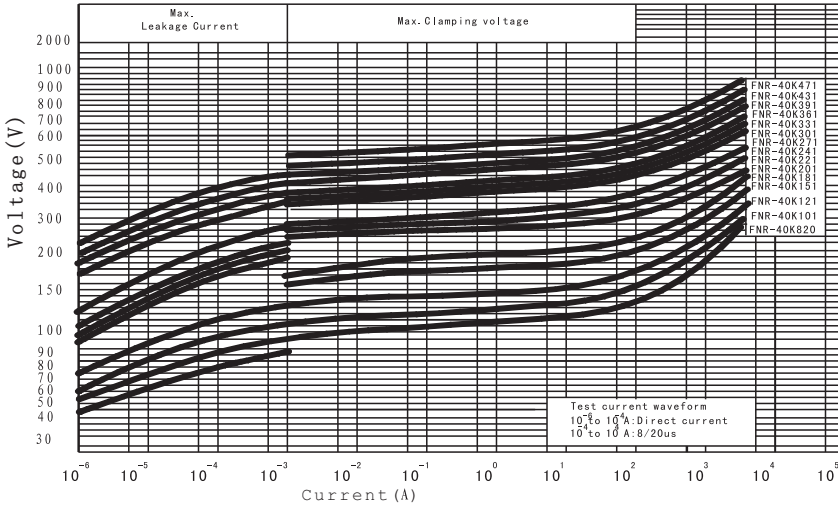

FNR-40K820 to FNR-40K471

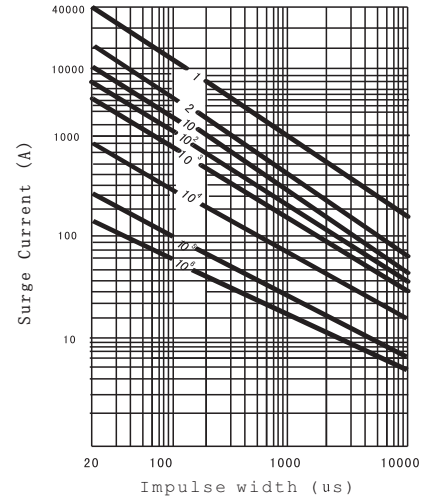

FNR-40K511 to FNR-40K182

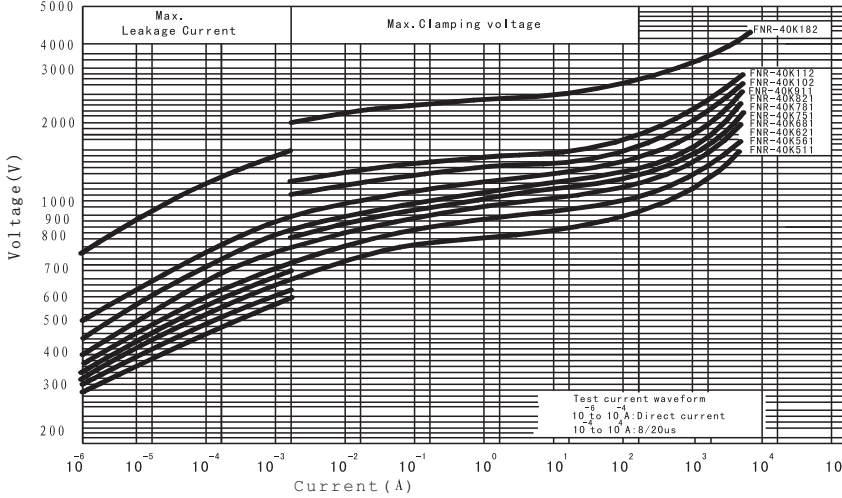

FNR-40K511 to FNR-40K182

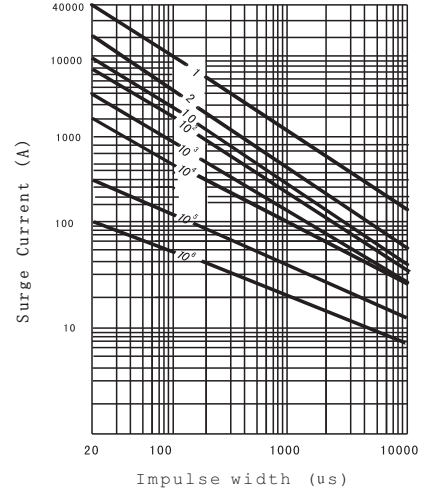

● 壓敏電阻器選用方法(參考) HOW TO SELECT A VARISTOR(ONLY REFERENCE)

A:壓敏電壓的選取

對於過壓保護方面的應用，壓敏電壓值應大于實際電路的電壓值，一般用以下公式計算：

$$V_v = a \cdot v / b \cdot c$$

a 電源電壓波動系數，一般取值1.2

v 在電路中壓敏電阻器兩端的電壓(交流時取電壓峰值,一般為交流標示有效值的1.414倍)

b 壓敏電壓誤差，一般取0.85

c 元件的老化系數，一般取0.9

A:Varistor voltage

Varistor Voltage should be more than the operating voltage in over protective circuit, The formula is shown as the following.

$$V_v = a \cdot v / b \cdot c$$

a-power Voltage ripple coefficient usually 1.2

v-DC Voltage (significant value only AC power)

b-Tolerance usually take 0.85

c-Ageing coefficient usually take 0.9

B:通流量的選取

通常產品給出的通流量是按照產品標準給定的波形、衝擊次數和間隙時間進行脈衝實驗時產品所能承受的最大電流值，產品所能承受的衝擊數是波形、幅值和間隙時間的函數，當電流波形幅值降低50%時衝擊次數可增加一倍，所以在實際應用中，壓敏電阻器所吸收的浪涌電流應小于產品的最大通流量，以延長產品的工作壽命。

B:Withstanding surge current

In general, withstanding surge current is max. Pulse current value which determined by test conditions such as wave- shape ,amplitude and intermal time, when the amplitude decrease to 50% of the initial , it should be increased to 2 times of the initial in order to keep the life longer, the surge current which is sbsorbed by the varistor should be less than max. withstanding surge current

C:注意事項與保護方法

- 1) 建議將長期工作電壓控制在壓敏電阻最大允許使用電壓的80%以下。如果超過額定值，可能會使壓敏電阻老化、短路。
- 2) 用于吸收感性負載(L)的浪涌時，請根據浪涌的能量以及施加次數，選擇合適的壓敏電阻。
- 3) 浪涌的大小無法推定時，為防止額定值以上的過大浪涌導致壓敏電阻破裂，請在回路中插入與壓敏電阻串聯的保險絲或溫度保險絲。還需要考慮其周圍的環境，比如安裝時遠離可燃物體等。

C:Warnings

- 1) It is recommended that the circuit voltage which is applied on a steady basis to be used at 80% or less of the max operating voltage. Exceeding the specification will cause deterioration, short-circuits and etc.
- 2) Select proper products according to the surge energy and the number of the impressions if the varistors are used to absorb the surge for an inductive loading.
- 3) Give consideration on the layout of the ambient parts not to be fixed close to combustible materials and to take measures on the circuits (fuses or thermo fuses) in case of varistors' short-circuit due to an excessive surge over the rating.

• 用途 APPLICATIONS

MODEL NUMBER 5mm	MODEL NUMBER 7mm	MODEL NUMBER 10mm	MODEL NUMBER 14mm	MODEL NUMBER 20mm	主要用途 Recommended Applications
FNR-05 K180	FNR-07 K180	FNR-10 K180	FNR-14 K180	FNR-20 K180	<ul style="list-style-type: none"> Protection of various kinds of semiconductors Protection of automobile equipment Absorption of switching surge from various kinds of relays and electro-magnetic valves (DC below 48V) Protection of electronic equipment from electrostatic discharge 積體電路、電晶體等半導體元件保護 汽車電裝品 DC 48V以下激磁線圈，如：繼電器、電磁等 靜電防制 移動電話
FNR-05 K220	FNR-07 K220	FNR-10 K220	FNR-14 K220	FNR-20 K220	
FNR-05 K270	FNR-07 K270	FNR-10 K270	FNR-14 K270	FNR-20 K270	
FNR-05 K330	FNR-07 K330	FNR-10 K330	FNR-14 K330	FNR-20 K330	
FNR-05 K390	FNR-07 K390	FNR-10 K390	FNR-14 K390	FNR-20 K390	
FNR-05 K470	FNR-07 K470	FNR-10 K470	FNR-14 K470	FNR-20 K470	
FNR-05 K560	FNR-07 K560	FNR-10 K560	FNR-14 K560	FNR-20 K560	
FNR-05 K680	FNR-07 K680	FNR-10 K680	FNR-14 K680	FNR-20 K680	
FNR-05 K820	FNR-07 K820	FNR-10 K820	FNR-14 K820	FNR-20 K820	<ul style="list-style-type: none"> Telephone. Communication line (DC 48V) 電話機用: DC48V通信回路
FNR-05 K101	FNR-07 K101	FNR-10 K101	FNR-14 K101	FNR-20 K101	
FNR-05 K121	FNR-07 K121	FNR-10 K121	FNR-14 K121	FNR-20 K121	
FNR-05 K151	FNR-07 K151	FNR-10 K151	FNR-14 K151	FNR-20 K151	
FNR-05 K181	FNR-07 K181	FNR-10 K181	FNR-14 K181	FNR-20 K181	<ul style="list-style-type: none"> AC 100V Line-Line Applications (Japan) 用于AC 100V電源綫之間(日本)
FNR-05 K201	FNR-07 K201	FNR-10 K201	FNR-14 K201	FNR-20 K201	
FNR-05 K221	FNR-07 K221	FNR-10 K221	FNR-14 K221	FNR-20 K221	
FNR-05 K241	FNR-07 K241	FNR-10 K241	FNR-14 K241	FNR-20 K241	<ul style="list-style-type: none"> AC 100V to 120V, Line-Line Applications (Japan, u.s., Canada) 用于AC100V、120V電源綫之間(日本、美國、加拿大等)
FNR-05 K271	FNR-07 K271	FNR-10 K271	FNR-14 K271	FNR-20 K271	
FNR-05 K301	FNR-07 K301	FNR-10 K301	FNR-14 K301	FNR-20 K301	
FNR-05 K331	FNR-07 K331	FNR-10 K331	FNR-14 K331	FNR-20 K331	<ul style="list-style-type: none"> Telephone Line Application (250V Insulation Resistance Test Applicable) 用于電話機250V絕緣阻抗測試。
FNR-05 K361	FNR-07 K361	FNR-10 K361	FNR-14 K361	FNR-20 K361	
FNR-05 K391	FNR-07 K391	FNR-10 K391	FNR-14 K391	FNR-20 K391	

MODEL NUMBER 5mm	MODEL NUMBER 7mm	MODEL NUMBER 10mm	MODEL NUMBER 14mm	MODEL NUMBER 20mm	主要用途 Recommended Applications
FNR-05 K431 FNR -05 K471	FNR-07 K431 FNR-07 K471	FNR-10 K431 FNR-10 K471	FNR-14 K431 FNR-14 K471	FNR-20 K431 FNR-20 K471	<ul style="list-style-type: none"> · AC200-220V Line-Line Applications · AC100V to 220V. Line-Ground Applications · Ac200-220電源綫間應用 · Ac100 to 220電源與對地應用
FNR-05 K561	FNR-07 K561 FNR-07 K621 FNR-07 K681	FNR-10 K561 FNR-10 K621 FNR-10 K681	FNR-14 K561 FNR-14 K621 FNR-14 K681	FNR-20 K561 FNR-20 K621 FNR-20 K681	<ul style="list-style-type: none"> · AC 240V Line-Line Applications (U.K., Australia, Middle East Countries) · AC 240V電源綫間應用 (英國、中東、澳洲等國)
		FNR-10 K751 FNR-10 K781 FNR-10 K821	FNR-14 K751 FNR-14 K781 FNR-14 K821	FNR-20 K751 FNR-20 K781 FNR-20 K821	<ul style="list-style-type: none"> · AC 380V, Line-Line Ground Applications AC 380V 電源綫間應用及電源對地間應用。
		FNR-10 K911	FNR-14 K911	FNR-20 K911	<ul style="list-style-type: none"> · AC 415V, Line-Line line-Ground Applications AC 415V電源綫間應用及電源對地間應用
		FNR-10 K102 FNR-10 K112	FNR-14 K102 FNR-14 K112	FNR-20 K102 FNR-20 K112	<ul style="list-style-type: none"> · AC 480V, Line-Line Ground Applications AC 480V 電源綫間應用及電源對地間應用
			FNR-14 K182	FNR-20 K182	<ul style="list-style-type: none"> · Line Ground Applications (For AC 1200V Withstanding Test) · AC 1200V電源對地間應用

● 保險絲配用建議(SELECT OF FUSE in conformity to FNR Varistor):

* 和壓敏電阻大小配合選用表 (If conform with diameter):

Part Number	FNR05K series	FNR07K series	FNR10K series	FNR14K series	FNR20K series
Fuse rating	1 To 2 A	2 to 3A	3 to 5A	3 to 10A	5 to 15A

* 和壓敏電阻最大峰值電流配合選用表 (If conform with Max Peak current):

Max. Peak Current8/20 μ S 1 time (A)	Up to 500	501 to 2000	2001 to 6000
Fuse rating	3A	5A	10A

● 建議儲存方法 Storage methods

元器件必須儲存在清潔、通風、無腐蝕性氣體的倉庫內；除另有規定外，倉庫的溫度和相對濕度必須滿足如下要求：溫度：5~30℃；相對濕度：20%~75%。

Components must be stored in a clean, ventilated, non-corrosive gases warehouse; Unless otherwise specified, the warehouse temperature and relative humidity must meet the following requirements: Temperature: 5 ~ 30 ℃; Relative humidity:20%~75%.

壓敏電阻器

ZINC OXIDE VARISTOR

● 電氣特性及測試方法 ELECTRICAL PERFORMANCE TEST

標準測試條件: 溫度:5℃~35℃, 濕度:45%~85%

Standard Test Conditions: Temperature: 5℃~35℃, humidity: 45%~85%

項目 Item	測試方法 Test method	性能 Performance
標稱壓敏電壓 Nominal varistor voltage	在規定電流條件(DC 1mA, 僅 $\phi 5$ 產品為DC 0.1mA)下的兩端電壓值定為標稱壓敏電壓。 The voltage between two terminals with the specified measuring current (DC 1mA, only $\phi 5$ for DC 0.1mA) applied is called V_V .	公差: $\pm 10\%$ Tolerance: $\pm 10\%$
漏電流 Leakage current	在壓敏電阻兩端施加實測壓敏電壓值的0.83倍電壓時, 通過壓敏電阻的直流電流值。 The direct current flowing from the Varistor at $0.83V_V$.	低壓產品(壓敏電壓不於68V)不於 $40\mu A$ 中高壓產品(壓敏電壓不於82V)不於 $13\mu A$ $V \leq 68V: I_L \leq 40\mu A$ $V > 82V: I_L \leq 13\mu A$
限制電壓 Clamping Voltage	在8/20 μS 波形下施加規定電流后壓敏電阻器兩端的電壓峰值。 The maximum voltage between two terminals with the specified standard impulse current(8/20 μS) applied.	請看電性能參數表格 Please see electrical characteristics
最大通流容量 Max peak current	施加1次8/20 μs 的標準衝擊電流后, 壓敏電阻電壓的變化率在 $\pm 10\%$ 以內時的最大電流值。 The maximum peak current within the varistor voltage change rate of $\pm 10\%$, when a single standard impulse of 8/20 μs is applied.	無可見損傷; 壓敏電壓變化率在 $\pm 10\%$ 內。 No visible damage; $-10\% \leq \Delta V/V \leq 10\%$
能量耐量 Maximum energy	施加1次2ms的方波后, 壓敏電阻電壓的變化率在 $\pm 10\%$ 以內時的最大能量。 The maximum energy within the varistor voltage change rate of $\pm 10\%$ when a single impulse of 2ms is applied.	無可見損傷; 壓敏電壓變化率在 $\pm 10\%$ 內。 No visible damage; $-10\% \leq \Delta V/V \leq 10\%$
電壓溫度係數 Temperature coefficient of varistor Voltage	在規定溫度下壓敏電壓的變化值。 Varistor Voltage changed percentage on Specified temperature.	$TCR \leq \pm 0.05\% / ^\circ C$
靜態電容量 Capacitance	條件: 1KHz, 1V Condition: 1KHz, 1V	請看電性能參數表格 Please see electrical characteristics
耐電壓 Voltage proof	條件: 2500VAC 引出端與外殼間1min. Condition: 2500VAC The distance of leads terminal and crust is 1 min.	要求: 外觀無可見損傷; 應無擊穿或飛弧。 Requirement: No visible damage; No breakdown or flashover.
絕緣電阻 Insulation resistance	條件: 500VDC Condition: 500VDC	$\geq 100 M\Omega$
脈衝壽命 Life against surge current cycles	在8/20 μS 波形下單方向施加規定脈衝電流 10^4 次, 間隔10s 10^4 surge currents (8/20 μs), unipolar, interval 10 s, amplitude corresponding to derating curve for 10^4 impulses at 20 μs	要求: 外觀無可見損傷; 壓敏電壓變化率在 $\pm 10\%$ 內。 Requirement: No visible damage; $-10\% \leq \Delta V/V \leq 10\%$

● 機械性能測試 MACHINE CHARACTERISTIC TEST

項目	試驗方法及測試設備	要求
引出端強度 Lead terminal tensile strength	條件：拉力：φ0.6、0.8mm：10N，φ1.0mm：20N；10±10S 彎曲：φ0.6、0.8mm：5N，φ1.0mm：10N；90°，二次 Condition： Force：φ0.6、0.8mm：10N，φ1.0mm：20N；10±1S Bend：φ0.6、0.8mm：10N，φ1.0mm：20N；90°，two times	要求：無可見損傷。 Requirement: No visible damage
可焊性 Solder ability	條件：試驗Tb,方法1; 槽焊法。距本體2±0.5mm 235±5℃；2±0.5s Condition: Test Tb, Method 1; Solder in trough method. 2±0.5mm from the body of the specimen T=235±5℃；t=2±0.5s	要求：焊料在2S內流合。 Requirement: Uniformly tinned in 2s.
標志耐溶劑 The sign of melted-resistant solvent	條件：70%的1.1.2三氯，1.2.2氟乙烷和30%的異丙醇的混合物；室溫， 浸漬5min；用脫脂棉在正反方向各擦拭5次，共10次；擦拭速度：2次/S。 Condition: Mixture with 70% 1.1.2 three chlorin, 1.2.2 fluorin- ethane and 30% cymene-alcohol; room temperature, dip 5 min; clean 5 times on positive and negative direction with absorbent cotton, total 10 times; cleaning speed: 2 times/S	要求：標志清晰。 壓敏電壓變化率 ≤ ±5% Requirement: Legible marking. -5% ≤ ΔV/V ≤ 5%
耐焊接熱 Resistance to soldering heat	條件：試驗Tb,方法1; 槽焊法。距本體2±0.5mm 260±5℃；5±1s; Condition: Test Tb, Method 1; Solder in trough method; 2±0.5mm from the body of the specimen T=260±5℃；t=5±1s	要求：無可見損傷 壓敏電壓變化率 ≤ ±5% 漏電流 ≤ 20μA (低壓產品 ≤ 40μA) Requirement: No visible damage -5% ≤ ΔV/V ≤ 5% I _L ≤ 20μA (V ≤ 68V; I _L ≤ 40μA)
振動 Vibration	條件：正弦波； 10Hz~55Hz~10Hz 一次掃描時間：1 min 振幅：0.75mm 或 98m/s ² (取較小者) 3個方向，共6h。 Condition: sine wave; 10Hz~55Hz~10Hz Scanning time once: 1 min Amplitude: 0.75mm or 98m/s ² (which is the less) 3 direction, total 6h.	要求：無可見損傷 壓敏電壓變化率 ≤ ±5% Requirement: No visible damage -5% ≤ ΔV/V ≤ 5%
碰撞 Impact	條件：390m/S ² 6ms 三個方向，共4000次。 Condition: 390m/S ² 6ms 3 Direction, total 4000 times.	要求：無可見損傷 壓敏電壓變化率 ≤ ±5% Requirement: No visible damage -5% ≤ ΔV/V ≤ 5%

● 氣候試驗 CLIMATIC ENVIRONMENT TEST

項目	試驗方法及測試設備	要求
溫度快速變化 Rapid change of temperature	條件: $\theta A: -40 \pm 2^{\circ}C$; $\theta B: 85 \pm 2^{\circ}C$; T1:30min t2:2min~3min 循環次數: 5次 Condition: $\theta A: -40 \pm 2^{\circ}C$; $\theta B: 85 \pm 2^{\circ}C$; T1:30min t2:2min~3min Cycle times:5	要求: 無可見損傷 壓敏電壓變化率 $\leq \pm 5\%$ Requirement: No visible damage $-5\% \leq \Delta V/V \leq 5\%$
高溫負荷 Endurance at upper category temperature	條件: $85 \pm 2^{\circ}C$ 施加電壓: 最大連續工作直流電壓 負荷方式: 連續 周期測量時間: 500h 累計試驗時間: 1000h Condition: $85 \pm 2^{\circ}C$, Inflicted voltage: 505VDC Burthen quomodo: continuous; Circular measure time: 500h Total testing time: 1000h	要求: 無可見損傷、標志清晰 壓敏電壓變化率 $\leq \pm 10\%$ Requirement: No visible damage, and legible marking; $-10\% \leq \Delta V/V \leq 10\%$
高溫貯存 Endurance at upper category temperature	條件: $125 \pm 2^{\circ}C$ 周期測量時間: 500h 恢復時間: 1000h Conidition: $125 \pm 2^{\circ}C$ Circular measure time: 500h Total testing time: 1000h	要求: 無可見損傷 壓敏電壓變化率 $\leq \pm 5\%$ Requirement: No visible damage $-5\% \leq \Delta V/V \leq 5\%$
氣候順序 Climatic sequence	條件: 干熱: $85 \pm 2^{\circ}C$, 16h 循環濕熱: Db, 一個循環, 24h, $55^{\circ}C$ 級; 低溫: $-40 \pm 3^{\circ}C$, 2h 循環濕熱: Db, 一個循環, 24h, $55^{\circ}C$ 級; Condition: Dry and heat: $85 \pm 2^{\circ}C$, 16h Low temperature $-40 \pm 3^{\circ}C$, 2h Circular wet and heat: Db, a cycle, 24h, $55^{\circ}C$ level;	要求: 無可見損傷 壓敏電壓變化率 $\leq \pm 5\%$ Requirement: No visible damage $-5\% \leq \Delta V/V \leq 5\%$
穩態濕熱 Steady state and damp heat	條件: 溫度: $40 \pm 2^{\circ}C$; 濕度: 90~95% 一半樣品不施加電壓, 另一半樣品施加最大連續直流電壓的10% 周期測量時間: 500h 累計試驗時間: 1000h Half of samples without voltage, others with 10 percent of the maximum continuous DC voltage Circular measure time: 500h Total testing time: 1000h	要求: 外觀無可見損傷 限制電壓變化率 $\leq \pm 20\%$ 壓敏電壓變化率 $\leq \pm 10\%$ Requirement: No visible damage. $-20\% \leq \Delta V_c/V_c \leq 20\%$ $-10\% \leq \Delta V/V \leq 10\%$

注: 以上要求測試電性能的項目, 應試驗后在標準條件下放置1~2小時后測試。

Note: When electrical test above are required, measurement shall be made after 1 or 2 hours of recovery under the standard condition.

● 阻燃試驗 Fire hazard testing

項目	試驗方法及測試設備	要求
着火 危險 Fire hazard	條件: 火焰施加點: 電阻器側面 火焰種類: 針焰, $12 \pm 1\text{mm}$ 施加火焰時間: 15s 次數: 3次 Condition: Position: ; Species: needle flame, $12 \pm 1\text{mm}$; T: 15s Times: 3	要求: 殘焰時間: 第一次、第二次不超過15s; 第三次不超過30s; 滴落物不引燃墊紙 Requirement: Flames or glowing of the specimen and the layer below extinguish in 15s for first and second time, 30s for the third after removal of the flame; No ignition of the wrapping tissue.

● 溫度降額曲綫 Derating Curve

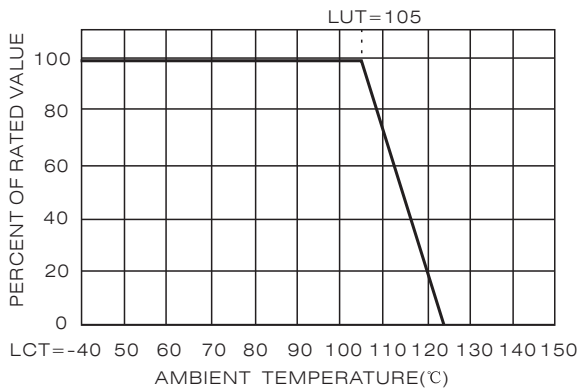

● 標準衝擊波形 Peak Pulse Current Test Waveform

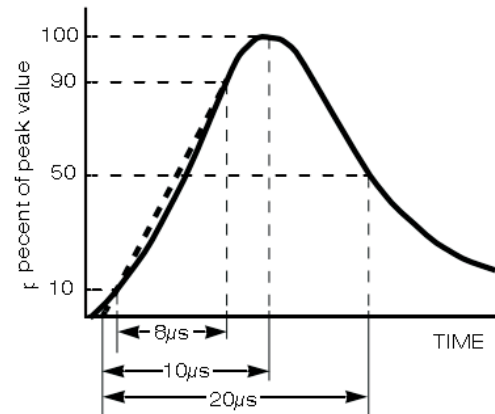

● 推薦波峰焊接曲綫 Recommended Wave Soldering Curve

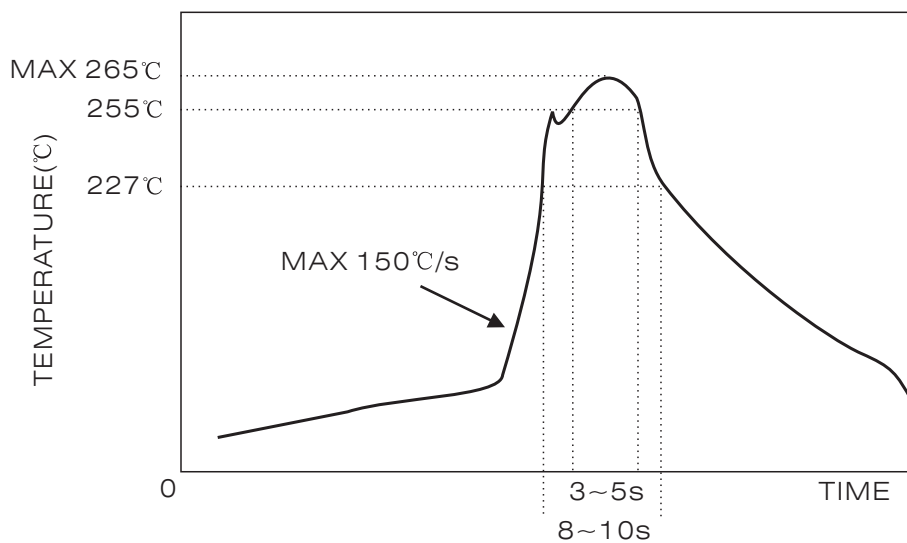

壓敏電阻器

ZINC OXIDE VARISTOR

● 高溫產品

工作溫度可達125℃，適用於持續高溫工作的場合。

Operating temperature up to 125℃(ambient), it is designed for the applications requiring high temperature.

型號系列 Part Series	壓敏電壓 Varistor Voltage	工作溫度 Operating temperature
07T series	82~680	-40~125℃
10T series	82~1100	-40~125℃
14T series	82~1100	-40~125℃
20T series	82~1100	-40~125℃

● 溫度降額曲線 Derating Curve

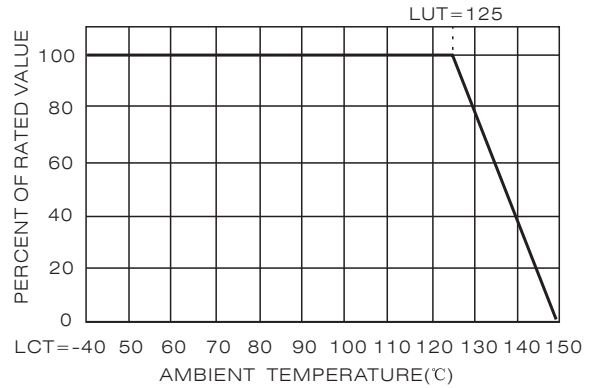

● 高溫產品訂貨方式

