

# SPECIFICATION FOR APPROVAL

CUSTOMER : \_\_\_\_\_

PRODUCT TYPE : SMD GLASS SEALING XTAL 3.2 × 2.5

NOMINAL FREQ. : 26.000000MHz

TXC P/N : 7V26006001

REVISION : A1

CUSTOMER P/N : \_\_\_\_\_

PM / SALES : \_\_\_\_\_

DATE : \_\_\_\_\_

CUSTOMER SIGNATURE & Date \_\_\_\_\_

\_\_\_\_\_

- (1) TXC requires one copy returned with signature and title of authorized individual that signifies acceptance of the attached specifications.
- (2) Orders received and accepted by TXC after return of signed copy of specification will be produced per these specifications.
- (3) Any changes to these specifications must be agreed upon by both parties and new revision of the Product Specification Sheet will be issued.
- (4) Any issuance of purchase order prior to consigning back the Approval page of "Specification Sheets" from customers will be regarded as the agreement on the contents of these specifications.

**MSL:Level 1  
RoHS Compliant**

Pb used in sealing glass material is exempt from EU directive

# PRODUCT SPECIFICATION SHEET

PRODUCT TYPE : SMD GLASS SEALING XTAL 3.2 × 2.5

---

NOMINAL FREQ. : 26.000000MHz

---

TXC P/N : 7V26006001

---

REVISION : A1

---

PE/RD	QA	MFG
<i>Shih-Yung Pao</i> Shih-Yung Pao	<i>Samson Xiong</i> Samson Xiong	<i>Jake Liu</i> Jake Liu
<i>4-Jan-13</i>	<i>4-Jan-13</i>	<i>4-Jan-13</i>

**NOTE:**

- (1)Lead Free Products are "Directive 2002/95/EC of The European Parliament of 27 January 2003 on the restriction of the use of certain hazardous substances (RoHS) in electrical and electronic equipment" Compliant (Attachment: SGS Test Report).
- (2)Revision "Sx" is for engineering samples only. PE/RD's approval required.
- (3)Revision "Ax" is production ready. PE, QA and MFG's approval required

**MSL:Level 1  
RoHS Compliant**

Pb used in sealing glass material is exempt from EU directive





## Spec Sheet Contents

No.	Content	Page
1	ELECTRICAL SPECIFICATIONS	P.3
2	FACTORY LOCATION	P.3
3	DIMENSIONS	P.4
4	MARKING	P.4
5	SUGGESTED REFLOW PROFILE& MANUAL SOLDER CONDITION	P.4
6	STRUCTURE ILLUSTRATION	P.5
7	EMBOSS CARRIER TAPE & REEL	P.6
8	PACKING	P.7
9	RELIABILITY SPECIFICATIONS	P.8~9

**■ ELECTRICAL SPECIFICATIONS**

**Standard atmospheric conditions**

Unless otherwise specified, the standard range of atmospheric conditions for making measurement and tests are as follow:

- Ambient temperature : 25±5°C
- Relative humidity : 40%~70%

If there is any doubt about the results, measurement shall be made within the following limits:

- Ambient temperature : 25±3°C
- Relative humidity : 40%~70%

**Measure equipment**

Electrical characteristics measured by S&A250B or equivalent.

**Crystal cutting type**

The crystal is using AT CUT (thickness shear mode).

**Unit Weight:**

0.018±0.001 g/pcs

	Parameters	SYM.	Electrical Spec.				Notes
			MIN	TYP	MAX	UNITS	
1	Nominal Frequency	FL	26.000000			MHz	-
2	Oscillation Mode	-	Fundamental			-	-
3	Load Capacitance	CL	12			pF	-
4	Frequency Tolerance	-	±10			ppm	at 25 ± 3 °C
5	Frequency Stability	-	±20			ppm	Over Operating Temp. Range (Reference 25°C )
6	Operating Temperature	-	-40	~	85	°C	-
7	Aging	-	±2			ppm	1st Year
8	Drive Level	DL	-	100	-	uW	-
9	Equivalent Resistance Rr	Rr	-	-	40	Ω	-
10	Shunt Capacitance C0	C0	-	-	3	pF	-
11	Insulation Resistance	-	500	-	-	MΩ	at DC 100V
12	Storage Temperature Range	-	-40	~	85	°C	-

**■ FACTORY LOCATION**

TXC (NINGBO) CORPORATION  
 NO.189 Huang Shan West Road, Beilun District,  
 Ningbo Zhejiang China

**■ DIMENSIONS**

(Unit:mm)

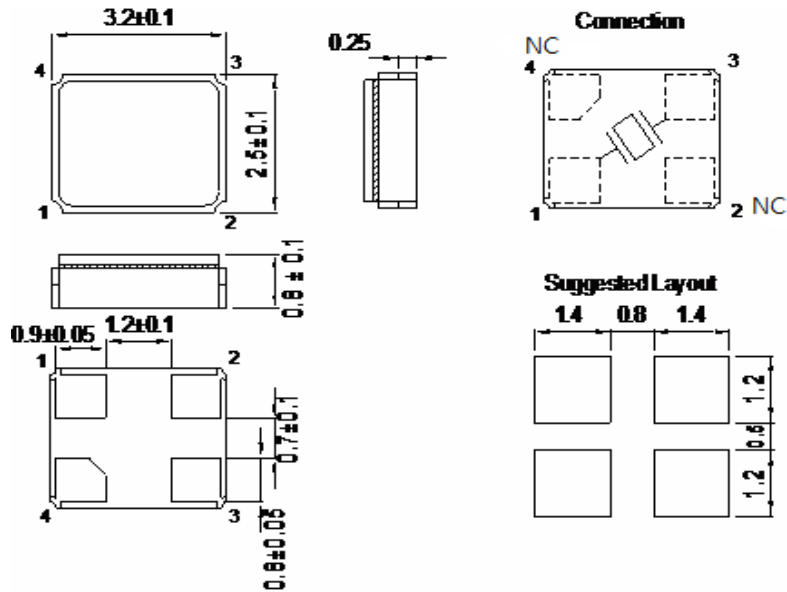

\*Coplanarity of solderable areas Camber 0.10 mm Max

**■ MARKING**

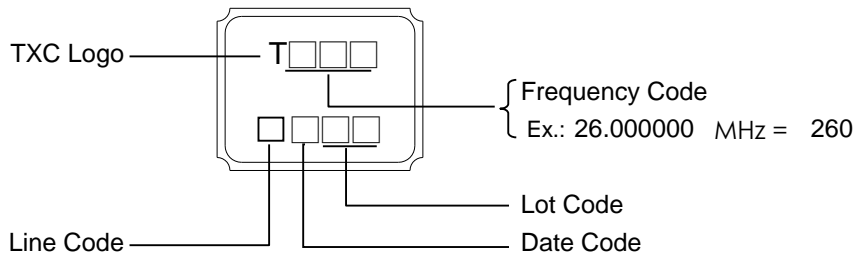

**Date Code:**

YEAR		MONTH													
		JAN	FEB	MAR	APR	MAY	JUN	JUL	AUG	SEP	OCT	NOV	DEC		
2005	2009	2013	2017	A	B	C	D	E	F	G	H	J	K	L	M
2006	2010	2014	2018	N	P	Q	R	S	T	U	V	W	X	Y	Z
2007	2011	2015	2019	a	b	c	d	e	f	g	h	j	k	l	m
2008	2012	2016	2020	n	p	q	r	s	t	u	v	w	x	y	z

\*This date code will be cycled every four years

**■ SUGGESTED REFLOW PROFILE**

Solder melting point :220±10 °C, 60 sec. Min.  
Peak Temperature: 260 ± 5 °C, 10 sec. Max.

**■ SUGGESTED MANUAL SOLDER CONDITION**

Temperature: 350 ± 10 °C  
Time: 3 sec.  
Re-solder times: twice

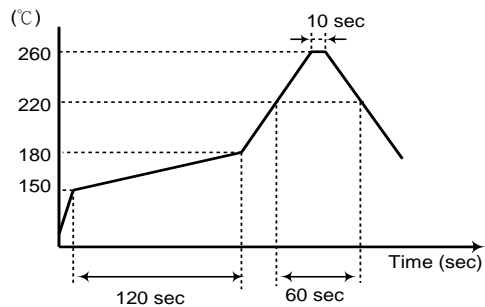

■ STRUCTURE ILLUSTRATION

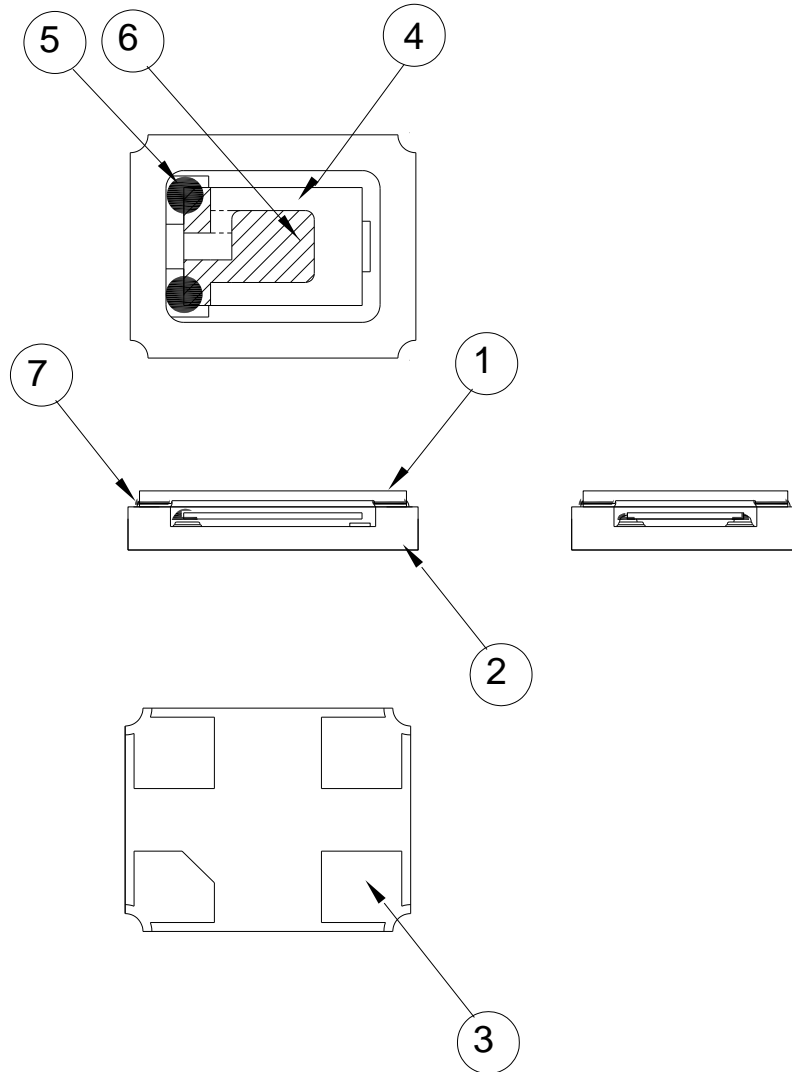

NO	COMPONENTS	MATERIALS	FINISH/SPECIFICATIONS
1	Cap	Ceramic (Al <sub>2</sub> O <sub>3</sub> )	-
2	Package	Ceramic (Al <sub>2</sub> O <sub>3</sub> )	-
3	PAD	Au	Tungsten metalize + Ni plating + Au plating
4	Crystal blank	SiO <sub>2</sub>	-
5	Conductive adhesive	Resin+Ag	-
6	Electrode	Ag	-
7	Sealing Glass	Glass(PbO)	-

■ **EMBOSS CARRIER TAPE & REEL**

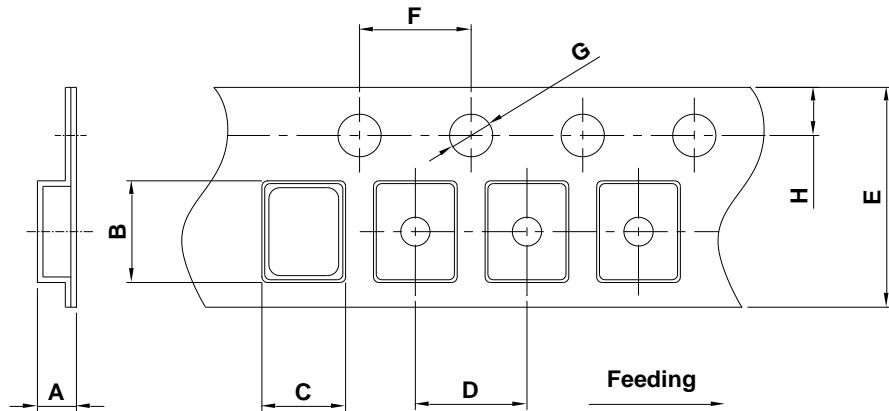

DIMENSIONS	A	B	C	D	E	F	G	H	(UNIT : mm)
	1.65±0.10	3.40±0.10	2.70±0.10	4.00±0.10	8.00±0.20	4.00±0.10	1.55±0.10	1.75±0.10	

REMARK :

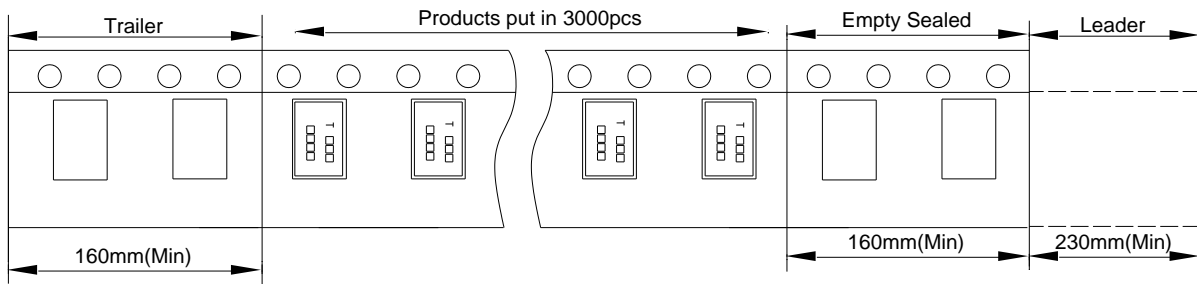

User direction of feed

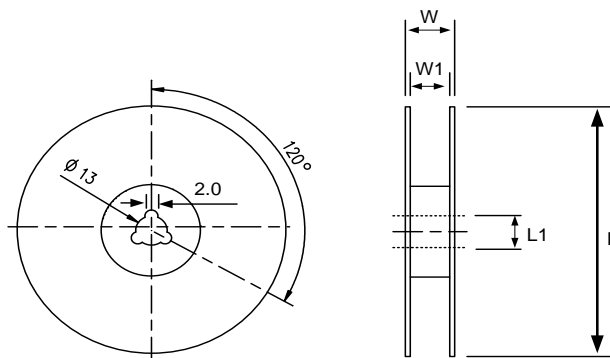

DIMENSIONS	L	L1	W	W1	(UNIT : mm)
	178±1.00	13±0.50	11.5±0.20	8±0.10	



**PACKING**

Reel Quantity :

- 1. Reel X 6 (6 Reels)
- 2. Reel X 12 (12 Reels)
- 3. Reel X 25 (12 Reels + 13 Reels)
- 4. Reel X 50 ( 12 Reelsx2 + 13 Reelsx2 )

Box Size:

- 1. L200 X W200 X H140mm
- 2. L200 X W200 X H250mm
- 3. L400 X W200 X H250mm
- 4. L400 X W400 X H280mm

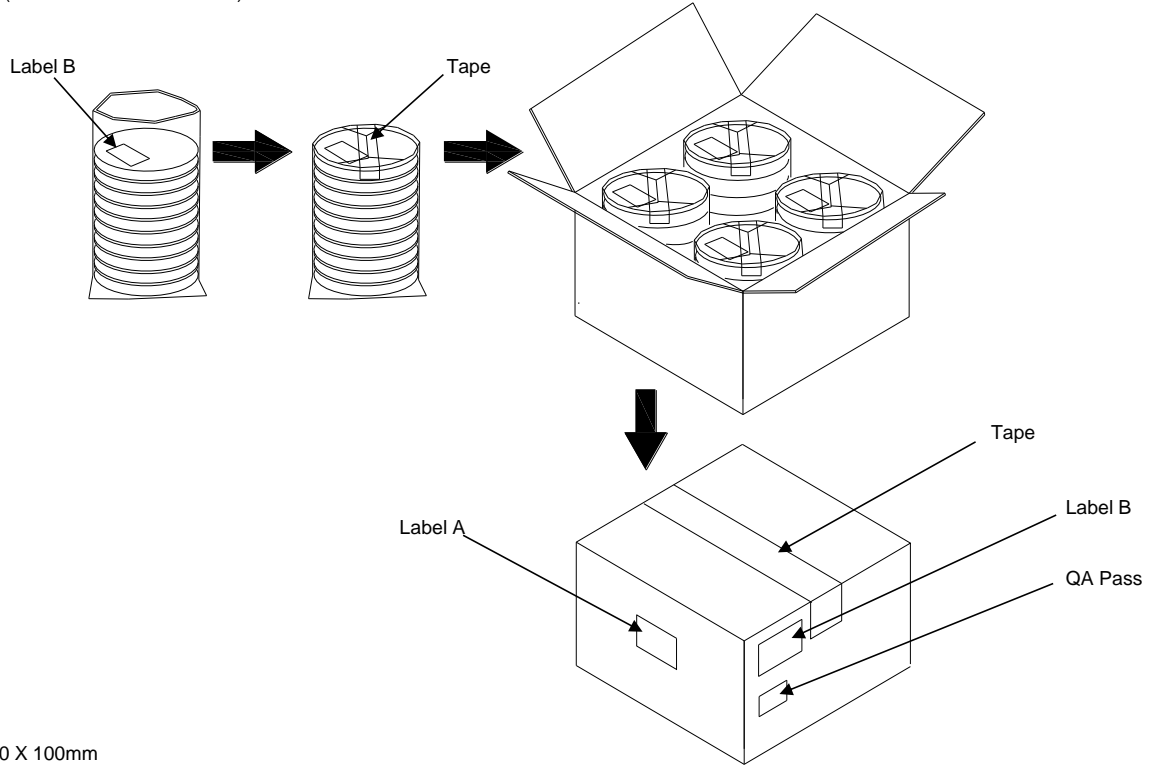

(Label A) Size:100 X 100mm

TXC
Inv No: 00096815
Po No: 21106326- 24- 1
Part No: <span style="border: 1px solid black; padding: 2px;">  </span> <span style="border: 1px solid black; padding: 2px;">  </span> <span style="border: 1px solid black; padding: 2px;">  </span> <span style="border: 1px solid black; padding: 2px;">  </span> <span style="border: 1px solid black; padding: 2px;">  </span> <span style="border: 1px solid black; padding: 2px;">  </span> <span style="border: 1px solid black; padding: 2px;">  </span> <span style="border: 1px solid black; padding: 2px;">  </span>
Qty: 40000 PCS
C/No: 157- 44

(Label B) Size:80 X 40mm

TXC CORPORATION		QA PASS
DATE CODE:	QTY:	2011/09/02
<span style="border: 1px solid black; padding: 2px;">  </span> <span style="border: 1px solid black; padding: 2px;">  </span> <span style="border: 1px solid black; padding: 2px;">  </span> <span style="border: 1px solid black; padding: 2px;">  </span> <span style="border: 1px solid black; padding: 2px;">  </span> <span style="border: 1px solid black; padding: 2px;">  </span> <span style="border: 1px solid black; padding: 2px;">  </span> <span style="border: 1px solid black; padding: 2px;">  </span>		<span style="border: 1px solid black; padding: 2px;">  </span> <span style="border: 1px solid black; padding: 2px;">  </span> <span style="border: 1px solid black; padding: 2px;">  </span> <span style="border: 1px solid black; padding: 2px;">  </span>
LOT NO:	<b>RoHS</b>	
PART NO:	<b>HF</b>	
FREQ: <span style="border: 1px solid black; padding: 2px;">  </span> <span style="border: 1px solid black; padding: 2px;">  </span> <span style="border: 1px solid black; padding: 2px;">  </span> <span style="border: 1px solid black; padding: 2px;">  </span> <span style="border: 1px solid black; padding: 2px;">  </span> <span style="border: 1px solid black; padding: 2px;">  </span> <span style="border: 1px solid black; padding: 2px;">  </span> <span style="border: 1px solid black; padding: 2px;">  </span> <span style="border: 1px solid black; padding: 2px;">  </span> <span style="border: 1px solid black; padding: 2px;">  </span> <span style="border: 1px solid black; padding: 2px;">  </span> <span style="border: 1px solid black; padding: 2px;">  </span>		

**[STORAGE]**

- 1.The storage time to be 1 year maximum.
- 2.Don't be caught in the rain.
- 3.The storage environment shall be 5°C ~40°C temperature and 30% ~ 75%RH humidity and free from the sun shine.
- 4.If customers have special requirements, we can paste labels according to it.

**■ RELIABILITY SPECIFICATIONS**
**1.Mechanical Endurance**

No.	Test Item	Test Methods	Test Criteria
1.1	Drop Test	150 cm height,3 times on concrete floor .	A . C
1.2	Mechanical Shock	Device are shocked to half sine wave ( 1000 G ) three mutually perpendicular axes each 3 times. 0.5 ms duration time	A . C
1.3	Vibration	Frequency range                      10 ~ 2000 Hz Amplitude                                    1.52 mm/20G Sweep time                                    20 minutes Perpendicular axes each test time    4 Hrs (Total test time 12 Hrs)	A . C
1.4	Solderability	Temperature                                245 °C ± 5°C Immersing depth                            0.5 mm minimum Immersion time                              5 ± 1 seconds Flux    Rosin resin methyl alcohol solvent ( 1 : 4 )	E

**2.Environmental Endurance**

No.	Test Item	Test Methods	Test Criteria
2.1	Resistance To Soldering Heat	Pre-heat temperature                      125 °C Pre-heat time                                60 ~ 120 sec. Test temperature                              260 ± 5 °C Test time                                        10 ± 1 sec.	B . C . D
2.2	High Temp. Storage	+ 125 °C ± 3 °C for 500 ± 12 Hrs	B . C . D
2.3	Low Temp. Storage	- 40 °C ± 3 °C for 500 ± 12 Hrs	B . C . D
2.4	Temperature cycle	Total 100 cycles of the following temperature cycle 	B . C . D
2.5	High Temp & Humidity	85°C ± 3°C , RH 85% , 500 Hrs	B . C . D



**RELIABILITY SPECIFICATIONS**

Specifications	
A	Frequency change: Within $\pm 5$ ppm or in customer's specification.
B	Frequency change: Within $\pm 10$ ppm or in customer's specification.
C	Equivalent series resistance(E.S.R) change: Within $\pm 15\%$ or $10\Omega$ (larger value).
D	After conditioning , quartz crystal units shall be subjected to standard atmospheric conditions for 2 hour, and measured.
E	Minimum 95% of immersed terminal shall be covered with new uniform solder.

**Measurement condition**

Electrical characteristics measured by S&A250B or equivalent.