

Description

The HSO8205 is the low R_{DS(on)} trenched N-CH MOSFETs. This product is suitable for Lithium-ion battery pack applications.

The HSO8205 meet the RoHS and Green Product requirement with full function reliability approved.

Product Summary

V _{DS}	20	V
R _{DS(ON),max}	27	mΩ
I _D	6	A

- Green Device Available
- Super Low Gate Charge
- Excellent C_{dv/dt} effect decline
- Advanced high cell density Trench technology

TSSOP8 Pin Configuration

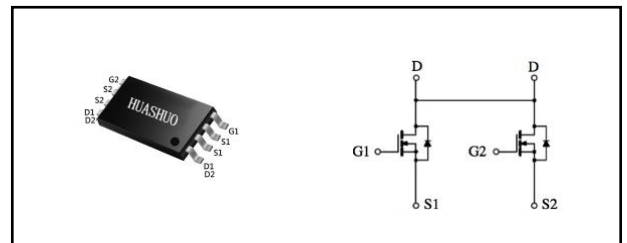

Absolute Maximum Ratings

Symbol	Parameter	Rating	Units
V _{DS}	Drain-Source Voltage	20	V
V _{GS}	Gate-Source Voltage	±12	V
I _D @T _A =25°C	Continuous Drain Current ₁	6	A
I _D @T _A =70°C	Continuous Drain Current ₁	5.4	A
I _{DM}	Pulsed Drain Current ₂	24	A
P _D @T _A =25°C	Total Power Dissipation ₃	1.5	W
T _{STG}	Storage Temperature Range	-55 to 150	°C
T _J	Operating Junction Temperature Range	-55 to 150	°C

Thermal Data

Symbol	Parameter	Typ.	Max.	Unit
R _{θJA}	Thermal Resistance Junction-ambient ₁	---	83	°C/W



Electrical Characteristics (T_J=25 °C, unless otherwise noted)

Symbol	Parameter	Conditions	Min.	Typ.	Max.	Unit
B _V DSS	Drain-Source Breakdown Voltage	V _{GS} =0V, I _D =250uA	20	---	---	V
R _{DS(ON)}	Static Drain-Source On-Resistance ²	V _{GS} =4.5V, I _D =6A	---	23	27	mΩ
		V _{GS} =2.5V, I _D =5.2A	---	30	38	
V _{GS(th)}	Gate Threshold Voltage	V _{GS} =V _{DS} , I _D =250uA	0.5	0.9	1.5	V
I _{DSS}	Drain-Source Leakage Current	V _{DS} =20V, V _{GS} =0V, T _J =25°C	---	---	1	uA
I _{GSS}	Gate-Source Leakage Current	V _{GS} =±12V, V _{DS} =0V	---	---	±100	nA
g _{fs}	Forward Transconductance	V _{DS} =5V, I _D =3.5A	---	21	---	S
Q _g	Total Gate Charge (4.5V)	V _{DS} =10V, V _{GS} =4.5V, I _D =3A	---	6.1	---	nC
Q _{gs}	Gate-Source Charge		---	1.7	---	
Q _{gd}	Gate-Drain Charge		---	1.4	---	
T _{d(on)}	Turn-On Delay Time	V _{DD} =10V, V _{GS} =4.5V, R _G =3Ω I _D =1A	---	10	---	ns
T _r	Rise Time		---	8.2	---	
T _{d(off)}	Turn-Off Delay Time		---	2.5	---	
T _f	Fall Time		---	6	---	
C _{iss}	Input Capacitance	V _{DS} =8V, V _{GS} =0V, f=1MHz	---	522	---	pF
C _{oss}	Output Capacitance		---	124	---	
C _{rss}	Reverse Transfer Capacitance		---	148	---	

Diode Characteristics

Symbol	Parameter	Conditions	Min.	Typ.	Max.	Unit
I _S	Continuous Source Current ^{1,4}	V _G =V _D =0V, Force Current	---	---	6	A
V _{SD}	Diode Forward Voltage ²	V _{GS} =0V, I _S =1A, T _J =25°C	---	---	1.2	V

Note :

- 1.The data tested by surface mounted on a 1 inch² FR-4 board with 2OZ copper.
- 2.The data tested by pulsed , pulse width ≤ 300us , duty cycle ≤ 2%
- 3.The power dissipation is limited by 150°C junction temperature
- 4.The data is theoretically the same as I_D and I_{DM} , in real applications , should be limited by total power dissipation.

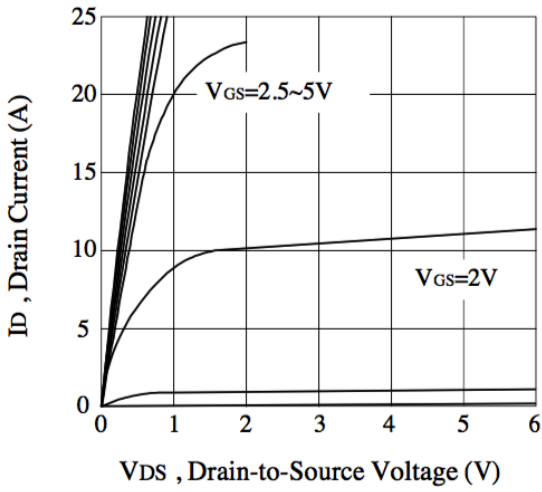

Figure 1. Output Characteristics

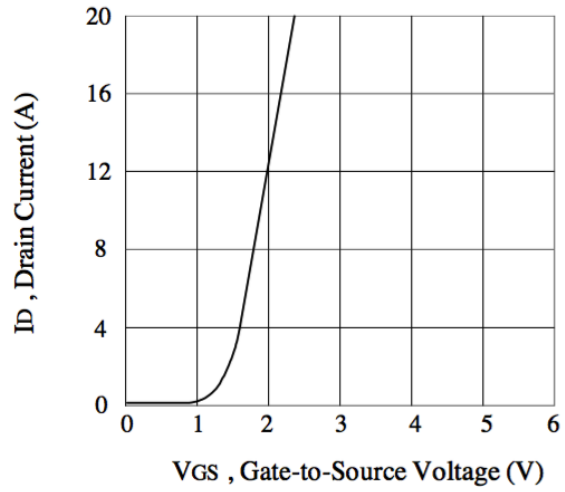

Figure 2. Transfer Characteristics

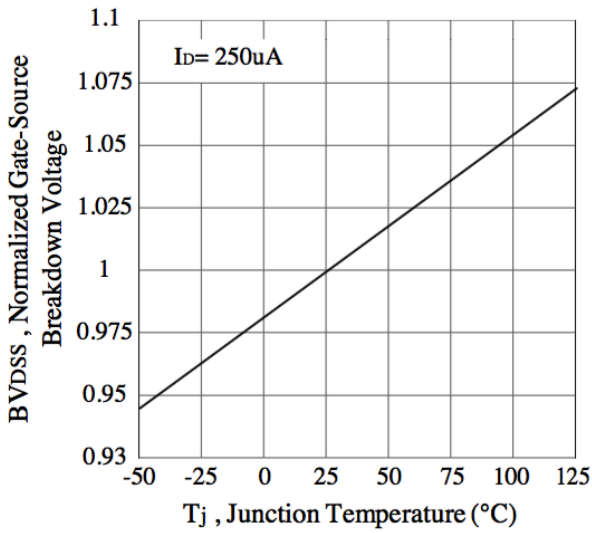

Figure 3. Breakdown Voltage Variation with Temperature

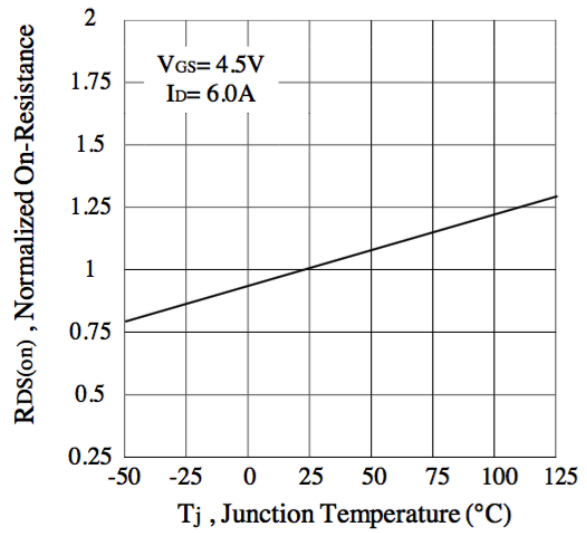

Figure 4. On-Resistance Variation with Temperature

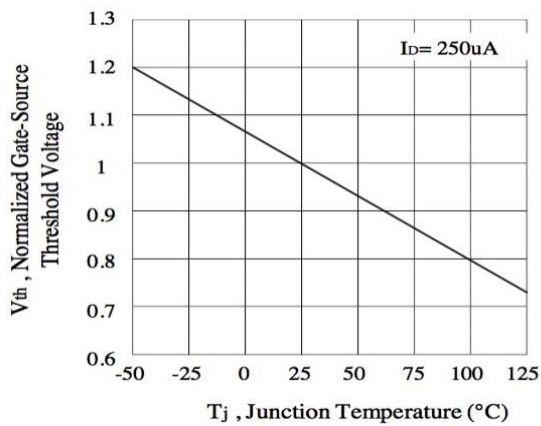

Figure 5. Gate Threshold Variation with Temperature

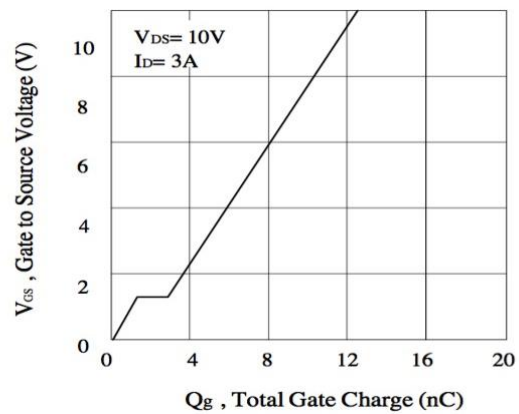
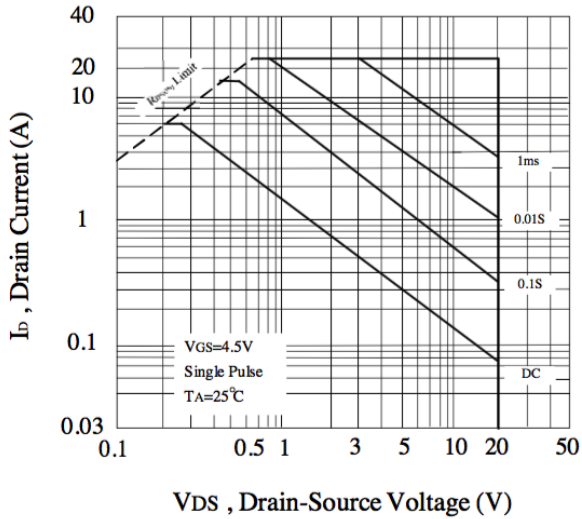
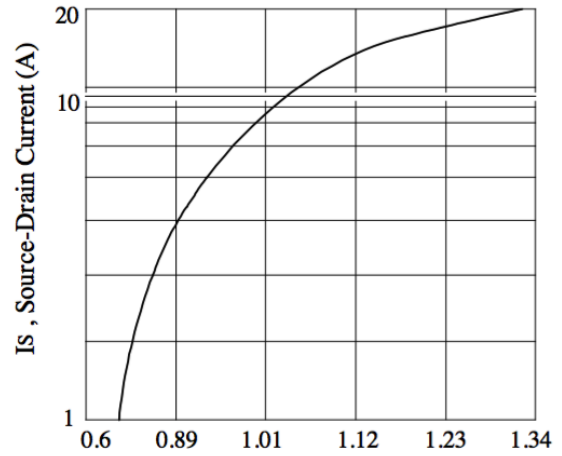

Figure 6. Gate Charge



VDS, Drain-Source Voltage (V)
Figure 7. Maximum Safe Operating Area



VSD, Body Diode Forward Voltage (V) Figure 8.
Body Diode Forward Voltage Variation with Source Current

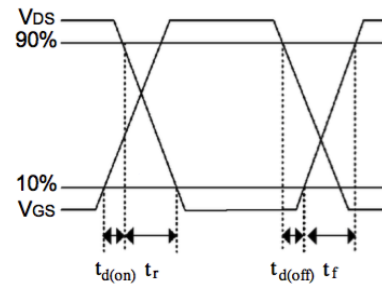
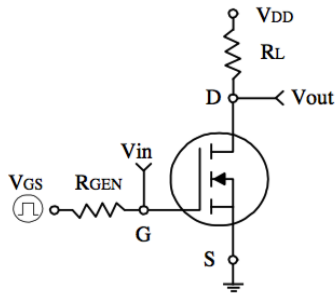

Figure 9. Switching Test Circuit and Switching Waveforms

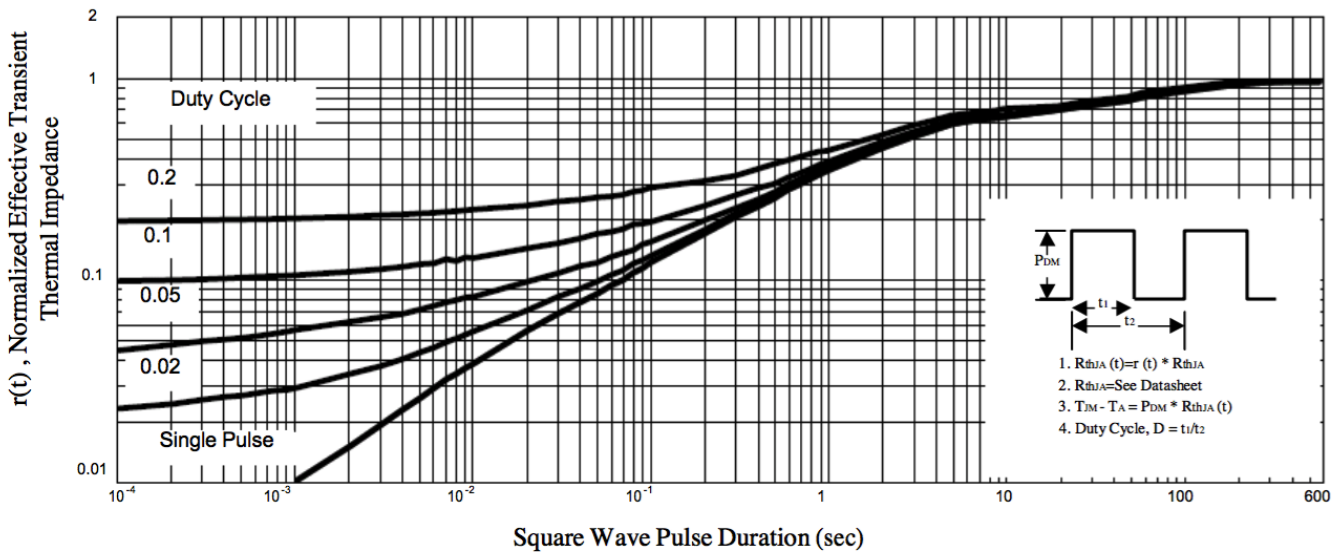
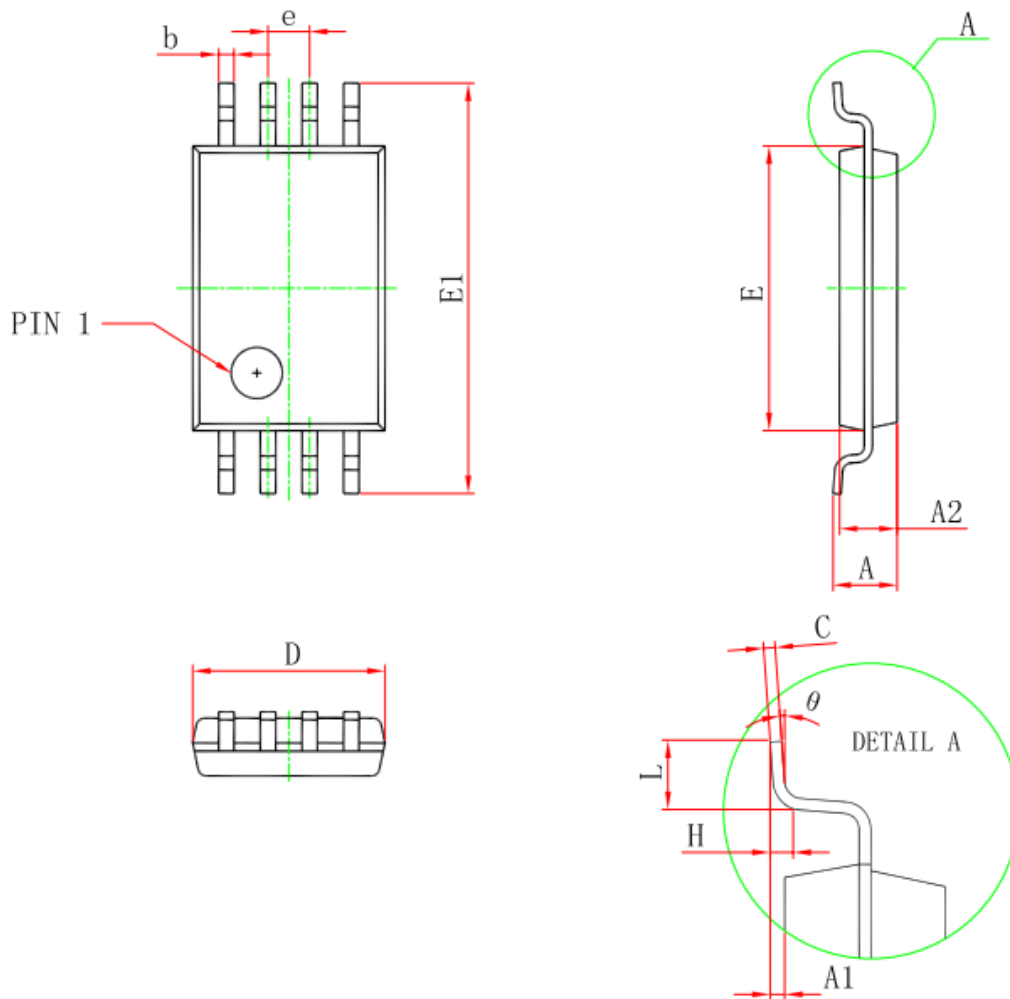

Figure 10. Normalized Thermal Transient Impedance Curve



TSSOP8 Package Outline Dimensions



Symbol	Dimensions In Millimeters		Dimensions In Inches	
	Min	Max	Min	Max
D	2.900	3.100	0.114	0.122
E	4.300	4.500	0.169	0.177
b	0.190	0.300	0.007	0.012
c	0.090	0.200	0.004	0.008
E1	6.250	6.550	0.246	0.258
A		1.200		0.047
A2	0.800	1.000	0.031	0.039
A1	0.050	0.150	0.002	0.006
e	0.65 (BSC)		0.026 (BSC)	
L	0.500	0.700	0.020	0.028
H	0.25(TYP)		0.01(TYP)	
θ	1°	7°	1°	7°