

Technical Data Sheet

3mm 1pcs Circuit Board Indicator

A214B/SDRSYGW/S530-A3

■ Features :

- Low power consumption
- High efficiency and low cost
- Good control and free combinations on the colors of LED lamps
- Good lock and easy to assembly
- Stackable and easy to assembly
- Stackable vertically and easy to assembly
- Versatile mounting on P.C board or panel
- Stackable horizontally and easy to assembly
- Pb free
- The product itself will remain within RoHS compliant version

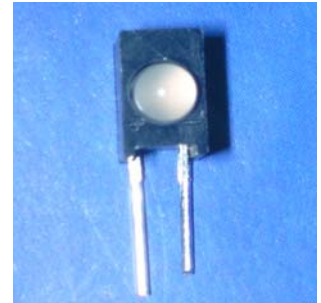

■ Descriptions :

- ARRAY=Plastic Holder+Combinations of Lamps
- The array will easily mount the applicable lamps on any panel up to

■ Applications :

- 1.Used as indicators of indicating the Degree, Functions, Positions etc, in electronic instruments.

PART NO.	Chip		Lens Color
	Material	Emitted Color	
264-2SDRSYGW/S530-A3	AlGaInP	Super Deep-Red	White Diffused
	AlGaInP	Super Yellow Green	

Technical Data Sheet
 3mm 1pcs Circuit Board Indicator

A214B/SDRSYGW/S530-A3

Package Dimensions

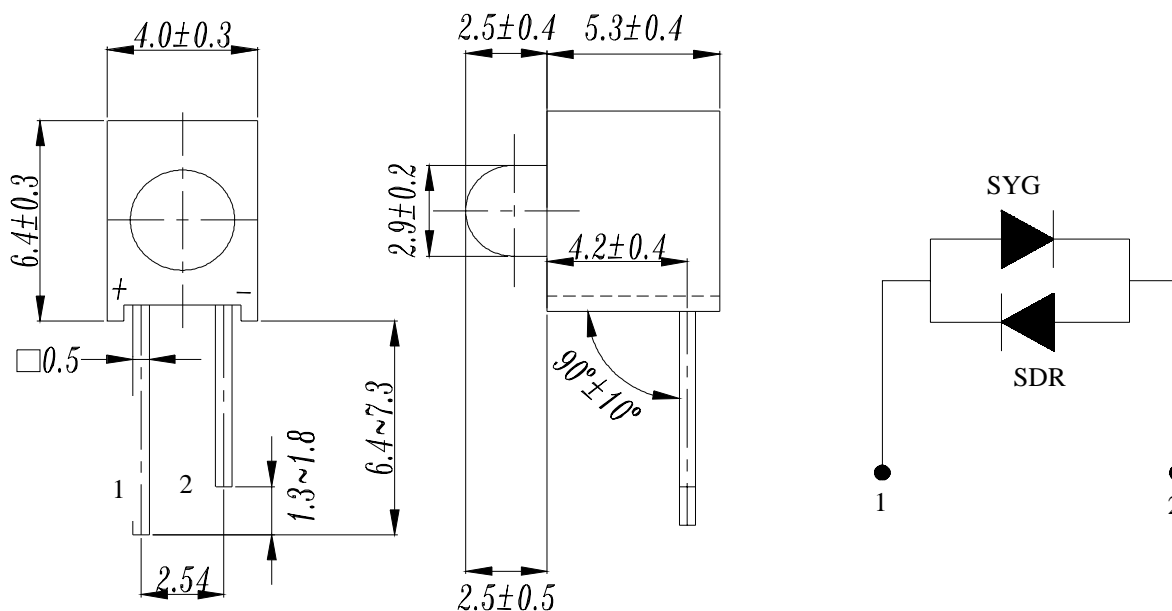

- Notes:
- 1.All dimensions are in millimeters, tolerance is 0.25mm except being specified
 - 2.Lead spacing is measured where the lead emerge from the package

 Absolute Maximum Ratings at $T_a = 25^\circ\text{C}$

Parameter	Symbol	Rating	Unit
Forward Current	I _F	SDRW/S530	25
		SYGW/S530	25
Operating Temperature	T _{opr}	-40 to +85	°C
Storage Temperature	T _{stg}	-40 to +100	°C
Soldering Temperature	T _{sol}	260 ± 5	°C
Electrostatic Discharge	ESD	SDRW/S530	2000
		SYGW/S530	2000
Power Dissipation	P _d	SDRW/S530	60
		SYGW/S530	60
Reverse Voltage	V _R	5	V

Note: *1:Soldering time \leq 5 seconds.



Technical Data Sheet

3mm 1pcs Circuit Board Indicator

A214B/SDRSYGW/S530-A3

Electro-Optical Characteristics (Ta=25°C)

Parameter	Symbol	Condition	Min	Typ	Max	Unit
Luminous Intensity	SDRW/S530	IV I _F = 2 mA	2.5	5.0	/	mcd
	SYGW/S530		2.5	5.0	/	
Peak Wavelength	SDRW/S530	λ p I _F = 20 mA	/	650	/	nm
	SYGW/S530		/	575	/	
Dominant Wavelength	SDRW/S530	λ d I _F = 20 mA	/	639	/	nm
	SYGW/S530		/	573	/	
Viewing Angle	2θ 1/2	I _F = 20 mA	/	100	/	deg
Spectrum Radiation Bandwidth	SDRW/S530	Δ λ I _F = 20 mA	/	20	/	nm
	SYGW/S530		/	20	/	
Forward Voltage	SDRW/S530	VF I _F = 20 mA	/	2.0	2.4	V
	SYGW/S530		/	2.0	2.4	
Reverse Current	SDRW/S530	IR V _R = 5 V	/	/	10	μ A
	SYGW/S530		/	/	10	

Technical Data Sheet
3mm 1pcs Circuit Board Indicator

A214B/SDRSYGW/S530-A3

■ Typical Electro-Optical Characteristic Curves:

(SDR)

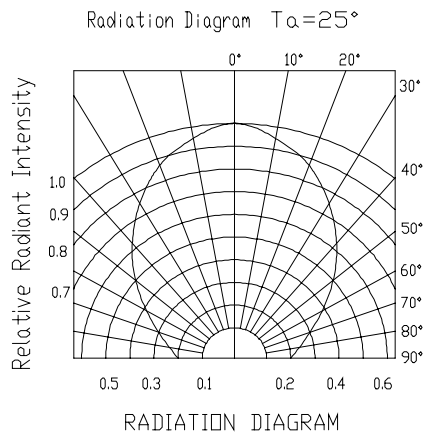
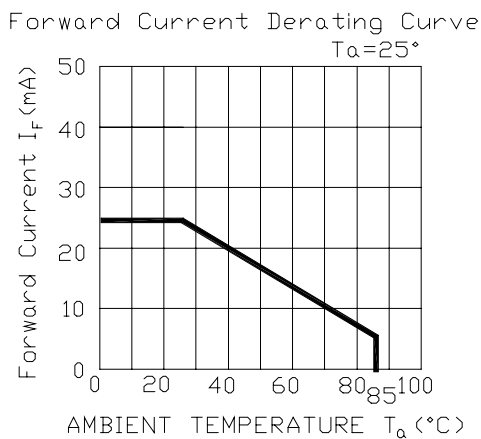
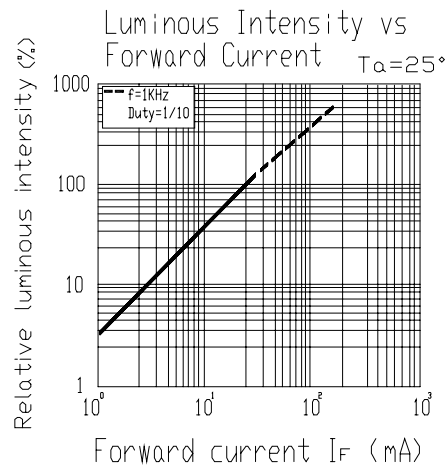
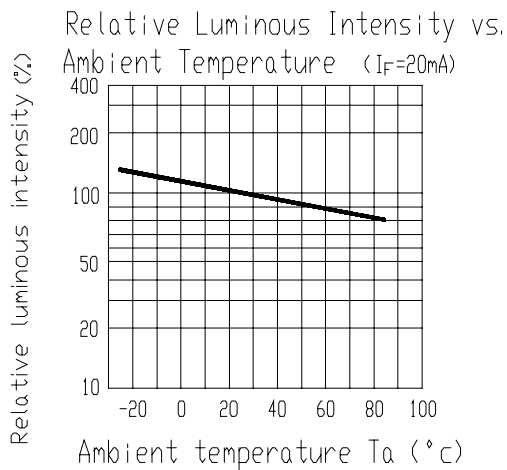
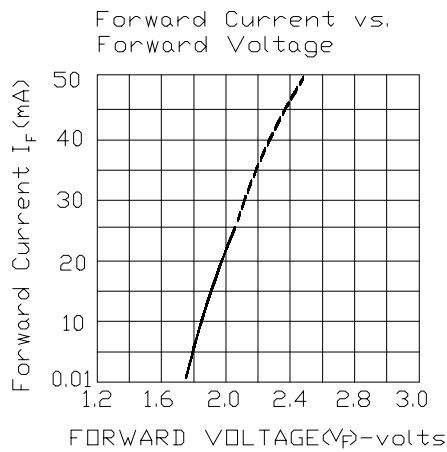
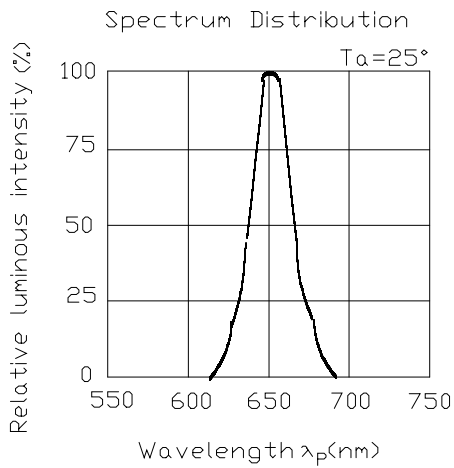

Technical Data Sheet
3mm 1pcs Circuit Board Indicator

A214B/SDRSYGW/S530-A3

■ Typical Electro-Optical Characteristic Curves:

(SYG)

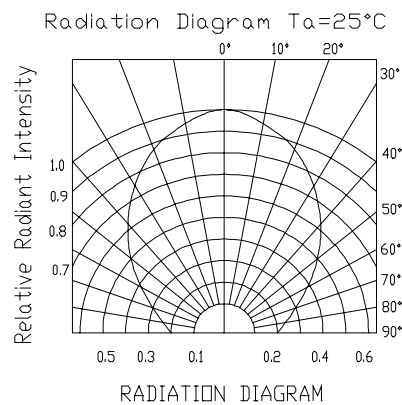
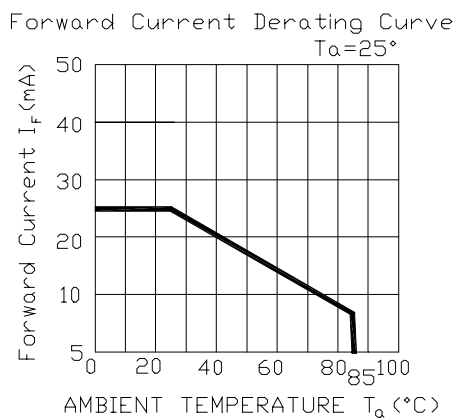
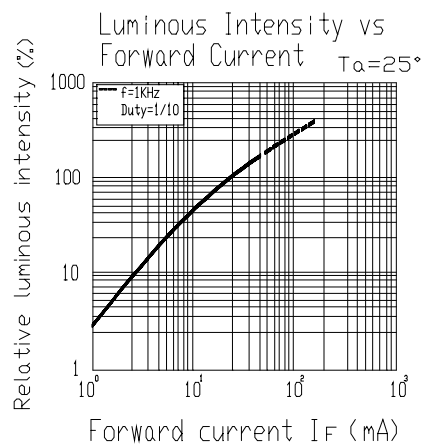
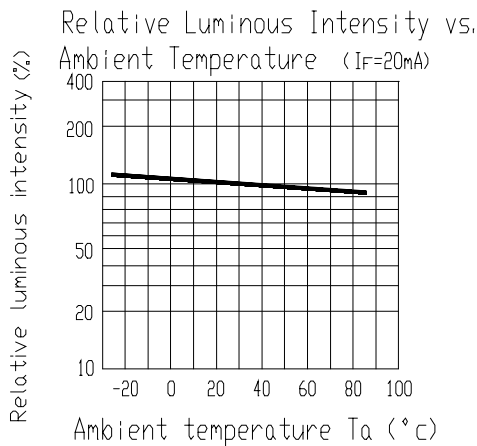
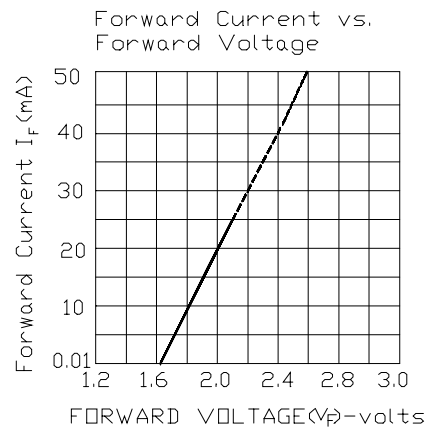
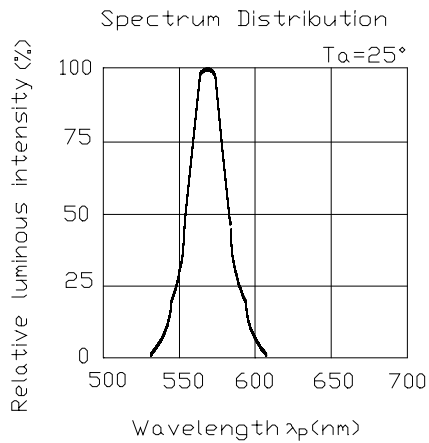



Technical Data Sheet

3mm 1pcs Circuit Board Indicator

A214B/SDRSYGW/S530-A3

■ Reliability test items and conditions:

The reliability of products shall be satisfied with items listed below.

Confidence level : 97%

LTPD : 3%

NO	Item	Test Conditions	Test Hours/Cycle	Sample Size	Failure Judgment Criteria	Ac/Re
1	Solder Heat	TEMP : 260°C ± 5 °C	10 SEC	76 PCS	$I_v \leq I_{vt} * 0.5$ or $V_f \geq U$ or $V_f \leq L$	0/1
2	Temperature Cycle	H : +100°C 15min \int 5 min L : -40°C 15min	300 CYCLES	76 PCS		0/1
3	Thermal Shock	H : +100°C 5min \int 10 sec L : -10°C 5min	300 CYCLES	76 PCS		0/1
4	High Temperature Storage	TEMP : 100°C	1000 HRS	76 PCS		0/1
5	Low Temperature Storage	TEMP : -40°C	1000 HRS	76 PCS		0/1
6	DC Operating Life	TEMP : 25°C $I_F = 20mA$	1000 HRS	76 PCS		0/1
7	High Temperature / High Humidity	85°C / 85% RH	1000 HRS	76 PCS		0/1

Note : I_{vt} : To test I_v value of the chip before the reliability test

I_v : The test value of the chip that has completed the reliability test

U : Upper Specification Limit

L : Lower Specification Limit



Technical Data Sheet

3mm 1pcs Circuit Board Indicator

A214B/SDRSYGW/S530-A3

Packing Quantity Specification

- 1.500PCS/1plate , 4 plates/1Box
- 2. 10Boxes/1Carton

Label Form Specification



CPN: Customer' s Production Number
P/N : Production Number
QTY: Packing Quantity
CAT: Ranks
HUE: Dominant Wavelength
REF: Reference
LOT No: Lot Number
MADE IN TAIWAN: Production Place

Notes

1. Above specification may be changed without notice. EVERLIGHT will reserve authority on material change for above specification.
2. When using this product, please observe the absolute maximum ratings and the instructions for using outlined in these specification sheets. EVERLIGHT assumes no responsibility for any damage resulting from use of the product which does not comply with the absolute maximum ratings and the instructions included in these specification sheets.
3. These specification sheets include materials protected under copyright of EVERLIGHT corporation. Please don' t reproduce or cause anyone to reproduce them without EVERLIGHT' s consent.

<i>EVERLIGHT ELECTRONICS CO., LTD.</i>	<i>Tel: 886-2-2267-2000, 2267-9936</i>
<i>Office: No 25, Lane 76, Sec 3, Chung Yang Rd,</i>	<i>Fax: 886-2267-6244, 2267-6189, 2267-6306</i>
<i>Tucheng, Taipei 236, Taiwan, R.O.C</i>	<i>http://www.everlight.com</i>