

	E480232
---	----------------

Features

- For Surface Mount Application in Order to Optimize Board Space
- Fast Response Time: Typical Less Than 1.0ps From 0 Volts to V_{BR} Minimum
- Low Inductance
- Low Profile Package
- Excellent Clamping Capability
- Halogen Free. "Green" Device (Note 1)
- Moisture Sensitivity Level 1
- Epoxy Meets UL 94 V-0 Flammability Rating
- Lead Free Finish/RoHS Compliant (Note2) ("P" Suffix Designates Compliant. See Ordering Information)
- For Bidirectional Devices Add "C" To The Suffix of The Part Number: i.e.SMCJ1.5KE6.8CA for 5% Tolerance

Mechanical Data

- Polarity: Color Band Denotes Positive End(Cathode) Except Bi-directional Types
- Maximum Soldering Temperature: 260 °C for 10 Seconds
- Terminals: Solderable Per MIL-STD-750, Method 2026

Maximum Ratings

- Operating Junction Temperature Range: -55°C to +175°C
- Storage Temperature Range: -55°C to +175°C
- Typical Thermal Resistance: 15°C/W Junction to Lead
- Typical Thermal Resistance: 75°C/W Junction to Ambient

Electrical Characteristics @ 25°C Unless Otherwise Specified

Peak Pulse Power Surge Current on 10/1000µs Waveform	I_{PP}	See the Table	Note 3
Peak Pulse Power Dissipation	P_{PP}	1500W(Min)	Note 3,4

Note:

1. Halogen free "Green" products are defined as those which contain <900ppm bromine, <900ppm chlorine (<1500ppm total Br + Cl) and <1000ppm antimony compounds.
2. High Temperature Solder Exemption Applied, see EU Directive Annex 7a.
3. Non-repetitive current pulse, per Fig.3 and derated above $T_A=25^\circ\text{C}$ per Fig.4.
4. Mounted on 8.0mm² copper pads to each terminal.

Pin Configuration:

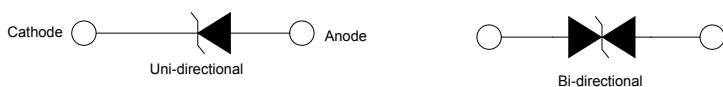

1500 Watt TVS 6.8 to 550 Volts

SMC (DO-214AB) (LEAD FRAME)

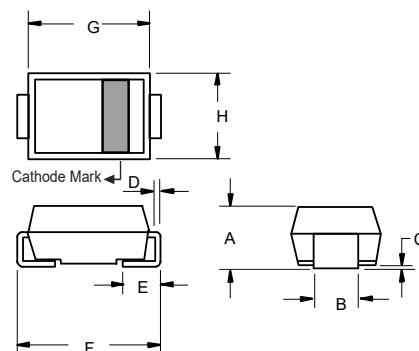

DIM	INCHES		MM		NOTE
	MIN	MAX	MIN	MAX	
A	0.079	0.103	2.00	2.62	
B	0.108	0.128	2.75	3.25	
C	0.002	0.008	0.051	0.203	
D	0.006	0.012	0.152	0.305	
E	0.030	0.060	0.76	1.52	
F	0.305	0.320	7.75	8.13	
G	0.260	0.280	6.60	7.11	
H	0.220	0.245	5.59	6.22	

Suggested Solder Pad Layout

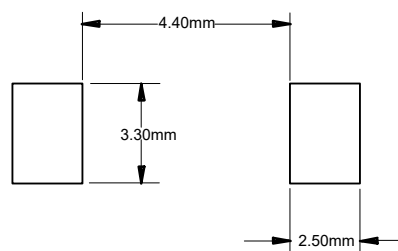

Electrical Characteristics @ 25°C Unless Otherwise Specified

MCC Part Number	Reverse Stand-Off Voltage	Breakdown Voltage $V_{BR}(V)$		Test Current	Max. Clamping Voltage @ I_{PP}	Peak Pulse Current	Reverse Leakage Current @ V_{WM}	Marking Code
		Min	Max					
Uni-directional	$V_{WM}(V)$			$I_T(mA)$	$V_C(V)$	$I_{PP}(A)$	$I_D(\mu A)$	
SMCJ1.5KE6.8A	5.80	6.45	7.14	10	10.5	144.8	1000	6V8A
SMCJ1.5KE7.5A	6.40	7.13	7.88	10	11.3	134.5	500	7V5A
SMCJ1.5KE8.2A	7.02	7.79	8.61	10	12.1	125.6	200	8V2A
SMCJ1.5KE9.1A	7.78	8.65	9.55	1	13.4	113.4	50	9V1A
SMCJ1.5KE10A	8.55	9.50	10.50	1	14.5	104.8	10	10A
SMCJ1.5KE11A	9.40	10.50	11.60	1	15.6	97.4	5	11A
SMCJ1.5KE12A	10.20	11.40	12.60	1	16.7	91.0	5	12A
SMCJ1.5KE13A	11.10	12.40	13.70	1	18.2	83.5	5	13A
SMCJ1.5KE15A	12.80	14.30	15.80	1	21.2	71.7	5	15A
SMCJ1.5KE16A	13.60	15.20	16.80	1	22.5	67.6	5	16A
SMCJ1.5KE18A	15.30	17.10	18.90	1	25.5	60.3	5	18A
SMCJ1.5KE20A	17.10	19.00	21.00	1	27.7	54.9	5	20A
SMCJ1.5KE22A	18.80	20.90	23.10	1	30.6	49.7	5	22A
SMCJ1.5KE24A	20.50	22.80	25.20	1	33.2	45.8	5	24A
SMCJ1.5KE27A	23.10	25.70	28.40	1	37.5	40.5	5	27A
SMCJ1.5KE30A	25.60	28.50	31.50	1	41.4	36.7	5	30A
SMCJ1.5KE33A	28.20	31.40	34.70	1	45.7	33.3	5	33A
SMCJ1.5KE36A	30.80	34.20	37.80	1	49.9	30.5	5	36A
SMCJ1.5KE39A	33.30	37.10	41.00	1	53.9	28.2	5	39A
SMCJ1.5KE43A	36.80	40.90	45.20	1	59.3	25.6	5	43A
SMCJ1.5KE47A	40.20	44.70	49.40	1	64.8	23.5	5	47A
SMCJ1.5KE51A	43.60	48.50	53.60	1	70.1	21.7	5	51A
SMCJ1.5KE56A	47.80	53.20	58.80	1	77.0	19.7	5	56A
SMCJ1.5KE62A	53.00	58.90	65.10	1	85.0	17.9	5	62A
SMCJ1.5KE68A	58.10	64.60	71.40	1	92.0	16.5	5	68A
SMCJ1.5KE75A	64.10	71.30	78.80	1	103.0	14.8	5	75A
SMCJ1.5KE82A	70.10	77.90	86.10	1	113.0	13.5	5	82A
SMCJ1.5KE91A	77.80	86.50	95.50	1	125.0	12.2	5	91A
SMCJ1.5KE100A	85.50	95.00	105.00	1	137.0	11.1	5	100A
SMCJ1.5KE110A	94.00	105.00	116.00	1	152.0	10.0	5	110A
SMCJ1.5KE120A	102.00	114.00	126.00	1	165.0	9.2	5	120A
SMCJ1.5KE130A	111.00	124.00	137.00	1	179.0	8.5	5	130A
SMCJ1.5KE150A	128.00	143.00	158.00	1	207.0	7.3	5	150A
SMCJ1.5KE160A	136.00	152.00	168.00	1	219.0	6.9	5	160A
SMCJ1.5KE170A	145.00	162.00	179.00	1	234.0	6.5	5	170A
SMCJ1.5KE180A	154.00	171.00	189.00	1	246.0	6.2	5	180A
SMCJ1.5KE200A	171.00	190.00	210.00	1	274.0	5.5	5	200A
SMCJ1.5KE220A	185.00	209.00	231.00	1	328.0	4.6	5	220A
SMCJ1.5KE250A	214.00	237.00	263.00	1	344.0	4.4	5	250A
SMCJ1.5KE300A	256.00	285.00	315.00	1	414.0	3.7	5	300A
SMCJ1.5KE350A	300.00	332.00	368.00	1	482.0	3.2	5	350A
SMCJ1.5KE400A	342.00	380.00	420.00	1	548.0	2.8	5	400A
SMCJ1.5KE440A	376.00	418.00	462.00	1	602.0	2.5	5	440A
SMCJ1.5KE480A	408.00	456.00	504.00	1	658.0	2.3	5	480A
SMCJ1.5KE510A	434.00	485.00	535.00	1	698.0	2.1	5	510A
SMCJ1.5KE530A	477.00	503.50	556.50	1	725.0	2.1	5	530A
SMCJ1.5KE540A	459.00	513.00	567.00	1	740.0	2.0	5	540A
SMCJ1.5KE550A	495.00	522.50	577.50	1	760.0	2.0	5	550A

1. For Bi-directional type having V_{WM} of 10 volts and less, the I_R limit is double.
2. The available parts are "A" type only, the parts without A (V_{BR} is $\pm 10\%$) is not available.

Electrical Characteristics @ 25°C Unless Otherwise Specified

MCC Part Number	Reverse Stand-Off Voltage	Breakdown Voltage $V_{BR}(V)$		Test Current	Max. Clamping Voltage @ I_{PP}	Peak Pulse Current	Reverse Leakage Current @ V_{WM}	Marking Code
		Min	Max					
Bi-directional	$V_{WM}(V)$			$I_T(mA)$	$V_C(V)$	$I_{PP}(A)$	$I_D(\mu A)$	
SMCJ1.5KE6.8CA	5.80	6.45	7.14	10	10.5	144.8	1000	6V8C
SMCJ1.5KE7.5CA	6.40	7.13	7.88	10	11.3	134.5	500	7V5C
SMCJ1.5KE8.2CA	7.02	7.79	8.61	10	12.1	125.6	200	8V2C
SMCJ1.5KE9.1CA	7.78	8.65	9.55	1	13.4	113.4	50	9V1C
SMCJ1.5KE10CA	8.55	9.50	10.50	1	14.5	104.8	10	10C
SMCJ1.5KE11CA	9.40	10.50	11.60	1	15.6	97.4	5	11C
SMCJ1.5KE12CA	10.20	11.40	12.60	1	16.7	91.0	5	12C
SMCJ1.5KE13CA	11.10	12.40	13.70	1	18.2	83.5	5	13C
SMCJ1.5KE15CA	12.80	14.30	15.80	1	21.2	71.7	5	15C
SMCJ1.5KE16CA	13.60	15.20	16.80	1	22.5	67.6	5	16C
SMCJ1.5KE18CA	15.30	17.10	18.90	1	25.5	60.3	5	18C
SMCJ1.5KE20CA	17.10	19.00	21.00	1	27.7	54.9	5	20C
SMCJ1.5KE22CA	18.80	20.90	23.10	1	30.6	49.7	5	22C
SMCJ1.5KE24CA	20.50	22.80	25.20	1	33.2	45.8	5	24C
SMCJ1.5KE27CA	23.10	25.70	28.40	1	37.5	40.5	5	27C
SMCJ1.5KE30CA	25.60	28.50	31.50	1	41.4	36.7	5	30C
SMCJ1.5KE33CA	28.20	31.40	34.70	1	45.7	33.3	5	33C
SMCJ1.5KE36CA	30.80	34.20	37.80	1	49.9	30.5	5	36C
SMCJ1.5KE39CA	33.30	37.10	41.00	1	53.9	28.2	5	39C
SMCJ1.5KE43CA	36.80	40.90	45.20	1	59.3	25.6	5	43C
SMCJ1.5KE47CA	40.20	44.70	49.40	1	64.8	23.5	5	47C
SMCJ1.5KE51CA	43.60	48.50	53.60	1	70.1	21.7	5	51C
SMCJ1.5KE56CA	47.80	53.20	58.80	1	77.0	19.7	5	56C
SMCJ1.5KE62CA	53.00	58.90	65.10	1	85.0	17.9	5	62C
SMCJ1.5KE68CA	58.10	64.60	71.40	1	92.0	16.5	5	68C
SMCJ1.5KE75CA	64.10	71.30	78.80	1	103.0	14.8	5	75C
SMCJ1.5KE82CA	70.10	77.90	86.10	1	113.0	13.5	5	82C
SMCJ1.5KE91CA	77.80	86.50	95.50	1	125.0	12.2	5	91C
SMCJ1.5KE100CA	85.50	95.00	105.00	1	137.0	11.1	5	100C
SMCJ1.5KE110CA	94.00	105.00	116.00	1	152.0	10.0	5	110C
SMCJ1.5KE120CA	102.00	114.00	126.00	1	165.0	9.2	5	120C
SMCJ1.5KE130CA	111.00	124.00	137.00	1	179.0	8.5	5	130C
SMCJ1.5KE150CA	128.00	143.00	158.00	1	207.0	7.3	5	150C
SMCJ1.5KE160CA	136.00	152.00	168.00	1	219.0	6.9	5	160C
SMCJ1.5KE170CA	145.00	162.00	179.00	1	234.0	6.5	5	170C
SMCJ1.5KE180CA	154.00	171.00	189.00	1	246.0	6.2	5	180C
SMCJ1.5KE200CA	171.00	190.00	210.00	1	274.0	5.5	5	200C
SMCJ1.5KE220CA	185.00	209.00	231.00	1	328.0	4.6	5	220C
SMCJ1.5KE250CA	214.00	237.00	263.00	1	344.0	4.4	5	250C
SMCJ1.5KE300CA	256.00	285.00	315.00	1	414.0	3.7	5	300C
SMCJ1.5KE350CA	300.00	332.00	368.00	1	482.0	3.2	5	350C
SMCJ1.5KE400CA	342.00	380.00	420.00	1	548.0	2.8	5	400C
SMCJ1.5KE440CA	376.00	418.00	462.00	1	602.0	2.5	5	440C
SMCJ1.5KE480CA	408.00	456.00	504.00	1	658.0	2.3	5	480C
SMCJ1.5KE510CA	434.00	485.00	535.00	1	698.0	2.1	5	510C
SMCJ1.5KE530CA	477.00	503.50	556.50	1	725.0	2.1	5	530C
SMCJ1.5KE540CA	459.00	513.00	567.00	1	740.0	2.0	5	540C
SMCJ1.5KE550CA	495.00	522.50	577.50	1	760.0	2.0	5	550C

1. For Bi-directional type having V_{WM} of 10 volts and less, the I_R limit is double.
2. The available parts are "A" type only, the parts without A (V_{BR} is $\pm 10\%$) is not available.

Curve Characteristics

Fig. 1 - Peak Pulse Power Rating Curve

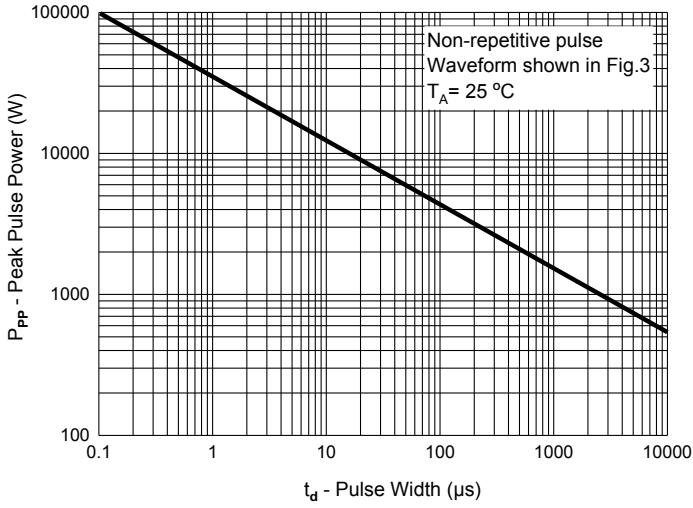

Fig. 2 - Typical Junction Capacitance

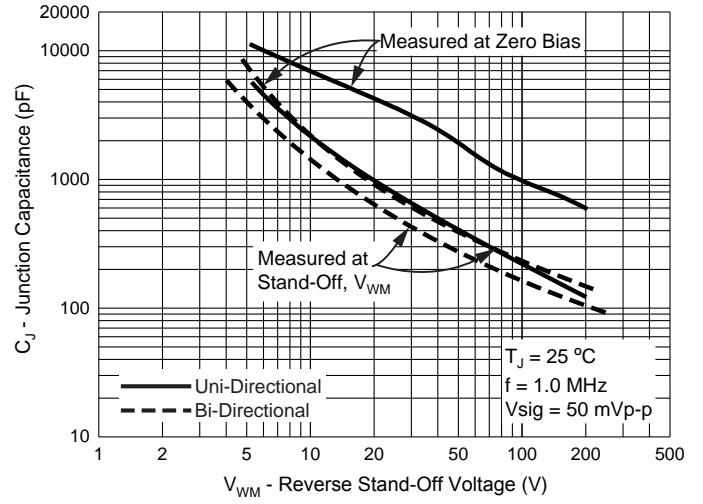

Fig. 3 - Pulse Waveform

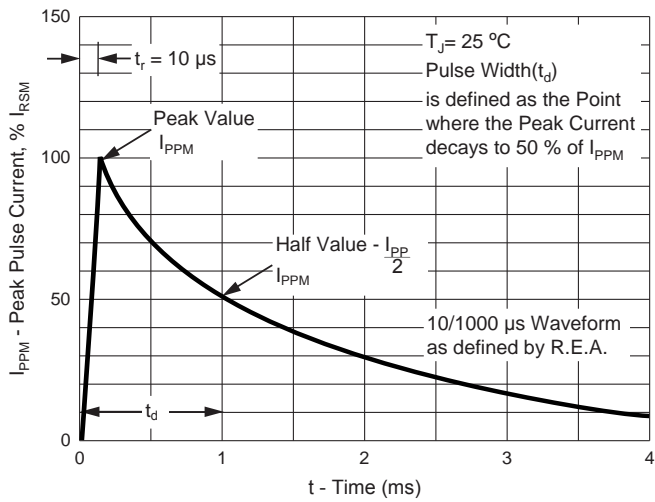
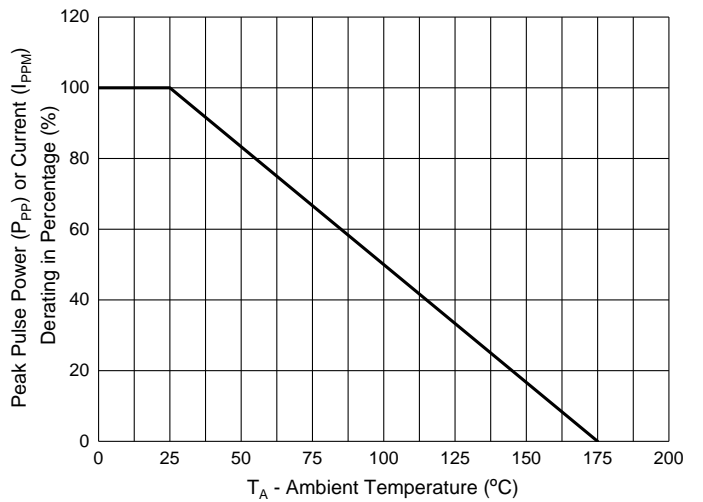

Fig. 4 - Pulse Derating Curve



Ordering Information

Device	Packing
Part Number-TP	Tape&Reel:3Kpcs/Reel

*****IMPORTANT NOTICE*****

Micro Commercial Components Corp. reserves the right to make changes without further notice to any product herein to make corrections, modifications, enhancements, improvements, or other changes. *Micro Commercial Components Corp.* does not assume any liability arising out of the application or use of any product described herein; neither does it convey any license under its patent rights, nor the rights of others. The user of products in such applications shall assume all risks of such use and will agree to hold *Micro Commercial Components Corp.* and all the companies whose products are represented on our website, harmless against all damages.

*****LIFE SUPPORT*****

MCC's products are not authorized for use as critical components in life support devices or systems without the express written approval of Micro Commercial Components Corporation.

*****CUSTOMER AWARENESS*****

Counterfeiting of semiconductor parts is a growing problem in the industry. Micro Commercial Components (MCC) is taking strong measures to protect ourselves and our customers from the proliferation of counterfeit parts. MCC strongly encourages customers to purchase MCC parts either directly from MCC or from Authorized MCC Distributors who are listed by country on our web page cited below. Products customers buy either from MCC directly or from Authorized MCC Distributors are genuine parts, have full traceability, meet MCC's quality standards for handling and storage. **MCC will not provide any warranty coverage or other assistance for parts bought from Unauthorized Sources.** MCC is committed to combat this global problem and encourage our customers to do their part in stopping this practice by buying direct or from authorized distributors.