

**SURFACE MOUNT
UNIDIRECTIONAL AND BIDIRECTIONAL
TRANSIENT VOLTAGE SUPPRESSORS**

**STAND-OFF VOLTAGE - 5.0 to 350 Volts
POWER DISSIPATION - 600 Watts**

FEATURES

- For surface mounted applications
- Reliable low cost construction utilizing molded plastic technique
- Typical IR less than 1uA above 10V
- Fast response time : typically less than 1.0ns for Uni-direction, less than 5.0ns for Bi-direction, from 0 volts to BV min
- RoHs compliant

MECHANICAL DATA

- Case : Molded plastic
- Case Material: Molding compound, UL Flammability classification 94V-0, (No Br. Sb. Cl.) "Halogen-free".
- Polarity : By cathode band denotes Uni-directional device none cathode band denotes Bi-directional device.
- Weight: 0.003 ounces, 0.093 grams

SMB

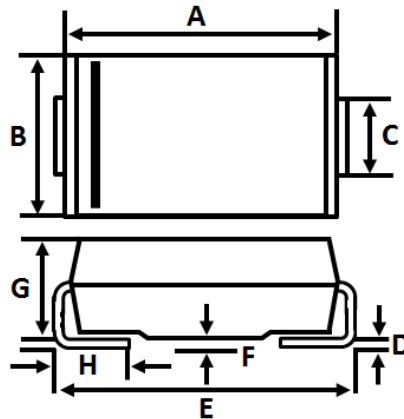

SMB		
DIM.	MIN.	MAX
A	4.06	4.57
B	3.30	3.93
C	1.96	2.21
D	0.15	0.31
E	5.21	5.59
F	0.05	0.20
G	2.01	2.50
H	0.76	1.52

All Dimensions in millimeter

MAXIMUM RATINGS AND ELECTRICAL CHARACTERISTICS

Ratings at 25°C ambient temperature unless otherwise specified.

ABSOLUTE RATINGS

PARAMETER	SYMBOL	VALUE	UNIT
Peak power dissipation @ $T_J = 25^\circ\text{C}$, $T_P = 1\text{ms}$ (Note 1)	P_{PK}	600	W
Peak forward surge current 8.3ms single half sine-wave @ $T_J = 25^\circ\text{C}$ (Note 2)	I_{FSM}	100	A
Steady state power dissipation @ $T_L = 120^\circ\text{C}$ lead lengths 0.375"(9.5mm), see fig. 4 without heatsink	$P_{M(AV)}$	1.5	W
Maximum instantaneous forward voltage at 16A f(Note 2,3)	V_F	2.5	V
Typical thermal resistance (Note 4)	RthJA RthJL RthJC	90 21 25	$^\circ\text{C/W}$
Operating temperature range	T_J	-55 to +175	$^\circ\text{C}$
Storage temperature range	T_{STG}	-55 to +175	$^\circ\text{C}$

NOTES:

REV.15, APR.-2020, KSIB02

1. Non-repetitive current pulse, per fig. 3 and derated above $T_J = 25^\circ\text{C}$ per fig.1
2. Only for unidirectional units.
3. V_F max = 2.5V at I_F 16A 300us square wave pulse.
4. Thermal resistance from junction to ambient, lead and case

Please be aware that an **Important Notice and Disclaimer** concerning availability, disclaimers, and use in Critical applications of LSC products thereto appears at the end of this Data Sheet.

FIG.1- Pulse Derating Curve

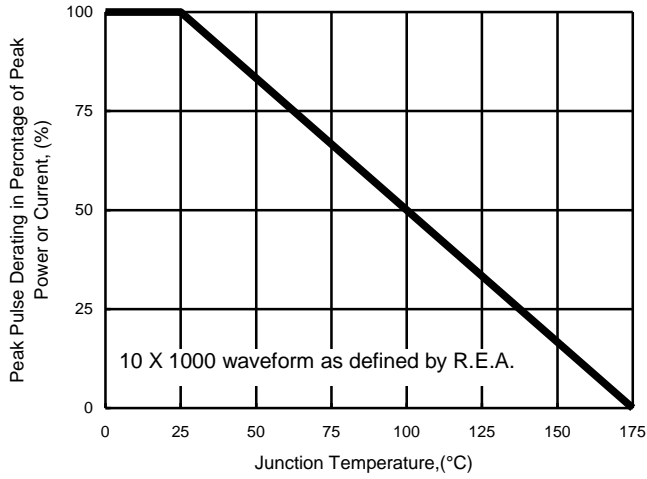

FIG.2- Maximum Non-Repetitive Surge Current

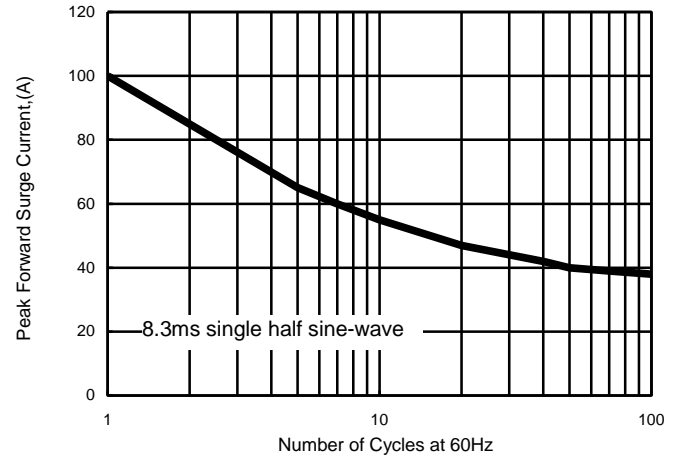

FIG.3- Pulse Waveform

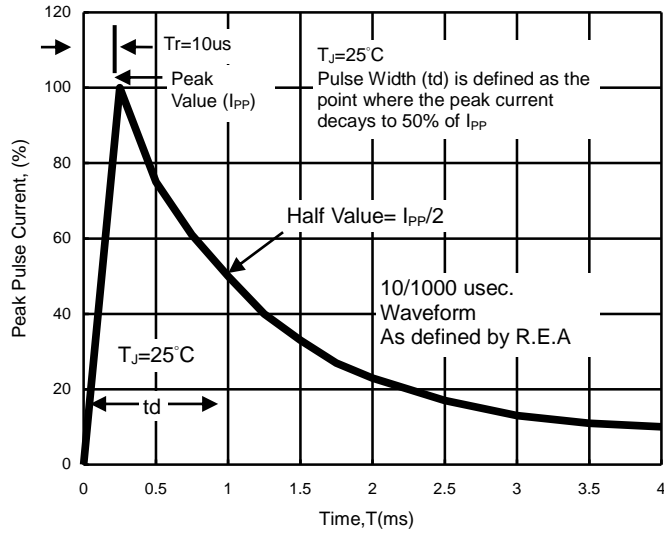

FIG.4- Typical Junction Capacitance

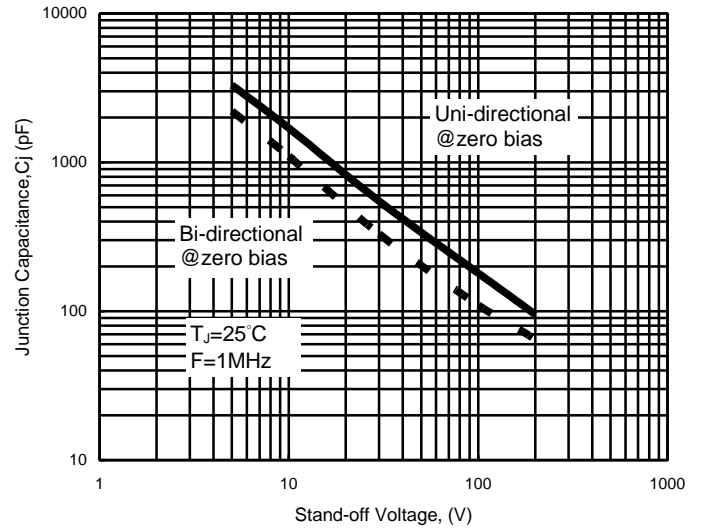

FIG.5- Peak Pulse Power Rating Curve

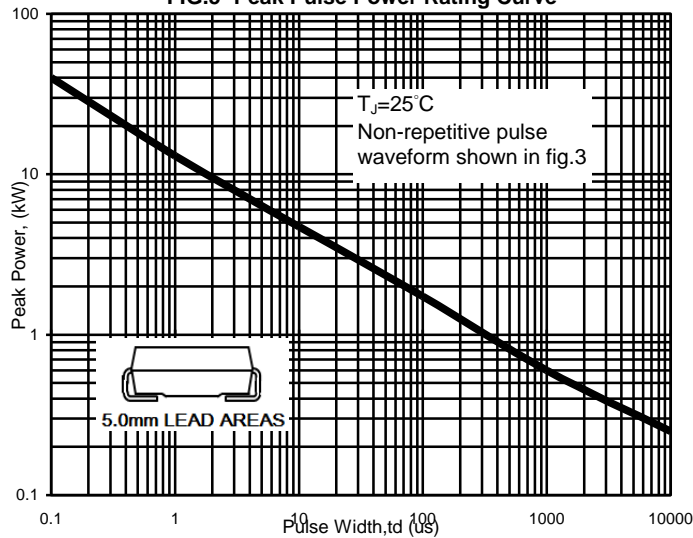
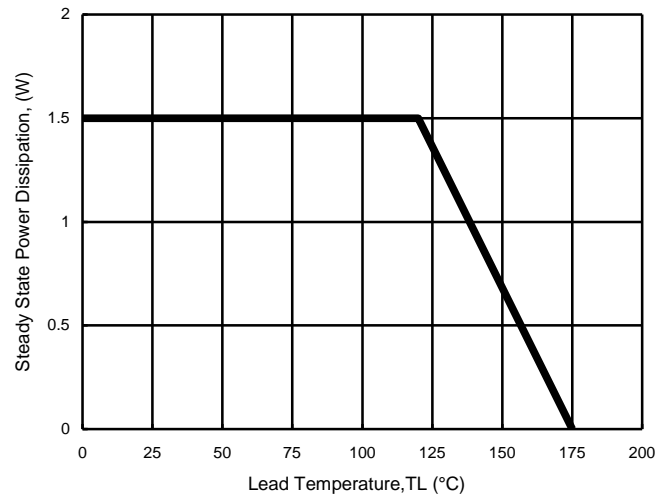

FIG.6- Steady State Power Derating Curve



SMBJ SERIES
Electrical Characteristics ($T_A = 25^\circ\text{C}$ unless otherwise noted)



Device		Marking code		Working reverse voltage	Breakdown voltage V_{BR} volts			Maximum reverse voltage at I_{RSM} (clamping voltage)	Maximum reverse surge current	Maximum reverse leakage at V_{RWM}
Uni	Bi	Uni	Bi	$V_R(V)$	Min	Max	@ $I_T(mA)$	$V_c(V)$	$I_{PP}(A)$	$I_R(\mu A)$
SMBJ5.0A	SMBJ5.0CA	KE	AE	5.0	6.40	7.07	10	9.2	65.2	800
SMBJ6.0A	SMBJ6.0CA	KG	AG	6.0	6.67	7.37	10	10.3	58.3	800
SMBJ6.5A	SMBJ6.5CA	KK	AK	6.5	7.22	7.98	10	11.2	53.6	500
SMBJ7.0A	SMBJ7.0CA	KM	AM	7.0	7.78	8.60	10	12.0	50.0	200
SMBJ7.5A	SMBJ7.5CA	KP	AP	7.5	8.33	9.21	1.0	12.9	46.5	100
SMBJ8.0A	SMBJ8.0CA	KR	AR	8.0	8.89	9.83	1.0	13.6	44.1	50.0
SMBJ8.5A	SMBJ8.5CA	KT	AT	8.5	9.44	10.40	1.0	14.4	41.7	20.0
SMBJ9.0A	SMBJ9.0CA	KV	AV	9.0	10.0	11.1	1.0	15.4	39.0	10.0
SMBJ10A	SMBJ10CA	KX	AX	10.0	11.1	12.3	1.0	17.0	35.3	5.0
SMBJ11A	SMBJ11CA	KZ	AZ	11.0	12.2	13.5	1.0	18.2	33.0	0.5
SMBJ12A	SMBJ12CA	LE	BE	12.0	13.3	14.7	1.0	19.9	30.2	0.5
SMBJ13A	SMBJ13CA	LG	BG	13.0	14.4	15.9	1.0	21.5	27.9	0.5
SMBJ14A	SMBJ14CA	LK	BK	14.0	15.6	17.2	1.0	23.2	25.8	0.5
SMBJ15A	SMBJ15CA	LM	BM	15.0	16.7	18.5	1.0	24.4	24.0	0.5
SMBJ16A	SMBJ16CA	LP	BP	16.0	17.8	19.7	1.0	26.0	23.1	0.5
SMBJ17A	SMBJ17CA	LR	BR	17.0	18.9	20.9	1.0	27.6	21.7	0.5
SMBJ18A	SMBJ18CA	LT	BT	18.0	20.0	22.1	1.0	29.2	20.5	0.5
SMBJ20A	SMBJ20CA	LV	BV	20.0	22.2	24.5	1.0	32.4	18.5	0.5
SMBJ22A	SMBJ22CA	LX	BX	22.0	24.4	27.0	1.0	35.5	16.9	0.5
SMBJ24A	SMBJ24CA	LZ	BZ	24.0	26.7	29.5	1.0	38.9	15.4	0.5
SMBJ26A	SMBJ26CA	ME	CE	26.0	28.9	31.9	1.0	42.1	14.2	0.5
SMBJ28A	SMBJ28CA	MG	CG	28.0	31.1	34.4	1.0	45.4	13.2	0.5
SMBJ30A	SMBJ30CA	MK	CK	30.0	33.3	36.8	1.0	48.4	12.4	0.5
SMBJ33A	SMBJ33CA	MM	CM	33.0	36.7	40.6	1.0	53.3	11.3	0.5
SMBJ36A	SMBJ36CA	MP	CP	36.0	40.0	44.2	1.0	58.1	10.3	0.5

SMBJ SERIES

Electrical Characteristics (T_A = 25°C unless otherwise noted)

Device		Marking code		Working reverse voltage	Breakdown voltage V _{BR} volts			Maximum reverse voltage at I _{RSM} (clamping voltage)	Maximum reverse surge current	Maximum reverse leakage at V _{RWM}
Uni	Bi	Uni	Bi	V _R (V)	Min	Max	@I _T (mA)	V _C (V)	I _{PP} (A)	I _R (uA)
SMBJ40A	SMBJ40CA	MR	CR	40.0	44.4	49.1	1.0	64.5	9.3	0.5
SMBJ43A	SMBJ43CA	MT	CT	43.0	47.8	52.8	1	69.4	8.6	0.5
SMBJ45A	SMBJ45CA	MV	CV	45.0	50	55.3	1	72.7	8.3	0.5
SMBJ48A	SMBJ48CA	MX	CX	48.0	53.3	58.9	1	77.4	7.7	0.5
SMBJ51A	SMBJ51CA	MZ	CZ	51.0	56.7	62.7	1	82.4	7.3	0.5
SMBJ54A	SMBJ54CA	NE	DE	54.0	60	66.3	1	87.1	6.9	0.5
SMBJ58A	SMBJ58CA	NG	DG	58.0	64.4	71.2	1	93.6	6.4	0.5
SMBJ60A	SMBJ60CA	NK	DK	60.0	66.7	73.7	1	96.8	6.2	0.5
SMBJ64A	SMBJ64CA	NM	DM	64.0	71.1	78.6	1	103	5.8	0.5
SMBJ70A	SMBJ70CA	NP	DP	70.0	77.8	86	1	113	5.3	0.5
SMBJ75A	SMBJ75CA	NR	DR	75.0	83.3	92.1	1	121	4.9	0.5
SMBJ78A	SMBJ78CA	NT	DT	78.0	86.7	95.8	1	126	4.7	0.5
SMBJ85A	SMBJ85CA	NV	DV	85.0	94.4	104	1	137	4.4	0.5
SMBJ90A	SMBJ90CA	NX	DX	90.0	100	111	1	146	4.1	0.5
SMBJ100A	SMBJ100CA	NZ	DZ	100.0	111	123	1	162	3.7	0.5
SMBJ110A	SMBJ110CA	PE	EE	110.0	122	135	1	177	3.4	0.5
SMBJ120A	SMBJ120CA	PG	EG	120.0	133	147	1	193	3.1	0.5
SMBJ130A	SMBJ130CA	PK	EK	130	144	159	1	209	2.9	0.5
SMBJ150A	SMBJ150CA	PM	EM	150	167	185	1	243	2.5	0.5
SMBJ160A	SMBJ160CA	PP	EP	160	178	197	1	259	2.3	0.5
SMBJ170A	SMBJ170CA	PR	ER	170	189	209	1	275	2.2	0.5
SMBJ188A	SMBJ188CA	PT	ET	188	209	231	1	328	1.83	0.5
SMBJ200A	SMBJ200CA	PV	EV	200	224	247	1	324	1.9	0.5
SMBJ220A	SMBJ220CA	PX	EX	220	246	272	1	356	1.7	0.5
SMBJ350A	---	QG	---	350	391	432	1	567	1.1	0.5

Notes:

1. Suffix 'A' denotes 5% tolerance device.
2. Add suffix 'C' or 'CA' after part number to specify Bi-directional devices.
3. The I_R limit is double for Bi-directional devices

IMPORTANT NOTICE AND DISCLAIMER

LSC reserves the right to make changes to this document and its products and specifications at any time without notice. Customers should obtain and confirm the latest product information and specifications before final design purchase or use.

ALL INFORMATION ARE PROVIDED AS-IS, EVEN IT HAS QUALIFIED BY THE AEC-Q101 WHICH SATISFY INDUSTRIAL APPLICATION REQUIREMENT, EXCEPT AS EXPRESSLY STATED IN THIS DATA SHEET IS APPLIED FOR AUTOMOTIVE GRADE, LSC MAKE NO WARRANTIES, REPRESENTATION OR GUARANTEE, WHETHER EXPRESS, IMPLIED OR STATUTORY, INCLUDING, WITHOUT LIMITATION, REGARDING ANY MERCHANTABILITY, SATISFACTORY QUALITY, OR FITNESS FOR A PARTICULAR PURPOSE WITH RESPECT TO THE LSC TECHNOLOGY.

LSC DOES NOT ASSUME ANY LIABILITY OR COMPENSATION FOR ANY APPLICATION ASSISTANCE OR CUSTOMER PRODUCT DESIGN, AND MAKE NO WARRANTY OR ACCEPT ANY LIABILITY WITH PRODUCTS, WHICH ARE PURCHASED OR USED FOR ANY UNINTENDED OR UNAUTHORIZED APPLICATION.

No license is granted by implication or otherwise under any intellectual property rights of LSC.

LSC products are not authorized for use as critical components in life support devices or systems without express written approval of LSC.