

SOT-23 Plastic-Encapsulate MOSFETS

N-Channel 20-V(D-S) MOSFET

■ Features

- $V_{DS}=20V, R_{DS(ON)}=40m\Omega @ V_{GS}=4.5V, I_D=5.0A$
- $V_{DS}=20V, R_{DS(ON)}=60m\Omega @ V_{GS}=2.5V, I_D=4.0A$
- $V_{DS}=20V, R_{DS(ON)}=75m\Omega @ V_{GS}=1.8V, I_D=1.0A$

MARKING

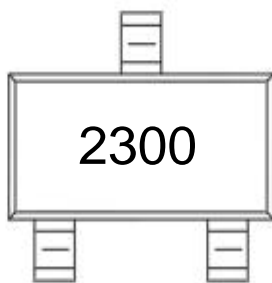

Equivalent Circuit

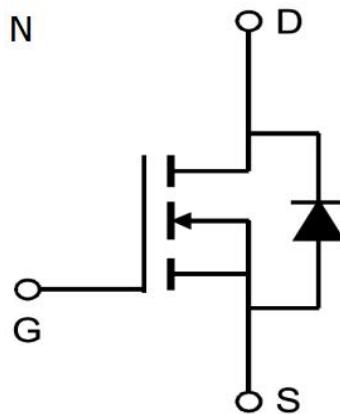

SOT-23

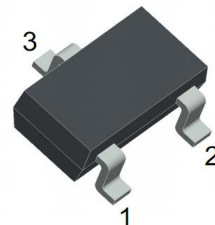

- 1.GATE
- 2.SOURCE
- 3.DRAIN

■ Absolute Maximum Ratings $T_a = 25^\circ C$

Parameter	Symbol	Rating	Unit	
Drain-Source Voltage	V_{DS}	20	V	
Gate-Source Voltage	V_{GS}	± 10	V	
Drain-Current	I_D	-Continuous * $T_J=125^\circ C$	3.8	A
		-Pulsed	15	A
Power Dissipation *	P_D	1.25	W	
Thermal Resistance, Junction- to-Ambient	R_{thJA}	100	$^\circ C/W$	
Operating Junction and Storage Temperature Range	T_j, T_{stg}	-55 to 150	$^\circ C$	

* Surface Mounted on FR 4 Board, $t \leq 10$ sec.

■ Electrical Characteristics Ta = 25°C

Parameter	Symbol	Testconditions	Min	Typ	Max	Unit
Drain-Source Breakdown Voltage	V _{DSS}	V _{GS} =0V, I _D =250uA	20			V
Zero Gate Voltage Drain Current	I _{DSS}	V _{DS} =20V, V _{GS} =0V			1	uA
Gate-Body Leakage	I _{GSS}	V _{GS} =±10V, V _{DS} =0V			±100	nA
Gate Threshold Voltage *	V _{GS(th)}	V _{GS} =V _{DS} , I _D =250uA	0.6	0.78	1.5	V
Drain- Source on-state Resistance *	R _{DS(ON)}	V _{GS} =4.5V, I _D =5.0A		32	40	mΩ
		V _{GS} =2.5V, I _D =4.0A		50	60	mΩ
		V _{GS} =1.8V, I _D =1.0A		62	75	mΩ
On-State Drain Current *	I _{D(ON)}	V _{DS} =5V, V _{GS} =4.5V	18			A
Forward Transconductance *	g _{FS}	V _{DS} =5V, I _D =5A	5			S
Input Capacitance	C _{ISS}	V _{DS} = 15V, V _{GS} = 0V, f = 1.0MHZ		888		pF
Output Capacitance	C _{OSS}			144		pF
Reverse Transfer Capacitance	C _{RSS}			115		pF
Turn-On Delay Time	t _{D(on)}			31.8		ns
Rise Time	t _r	V _{DD} =10V, I _D =1A, V _{GS} =4.5V, R _L =10Ω, R _{GEN} =6Ω		14.5		ns
Turn-Off Delay Time	t _{D(off)}			50.3		ns
Fall Time	t _f			31.9		ns
Total Gate Charge	Q _g	V _{DS} = 10V, I _D = 3.5A, V _{GS} = 4.5V		16.8		nC
Gate-Source Charge	Q _{gs}			2.5		nC
Gate-Drain Charge	Q _{gd}			5.4		nC
Drain-Source Diode Forward Current *	I _S				1.25	A
Diode Forward Voltage	V _{SD}	V _{GS} =0V, I _S =1.25A		0.825	1.2	V

* Pulse Test: Pulse Width ≤ 300 μs, Duty Cycle ≤ 2%

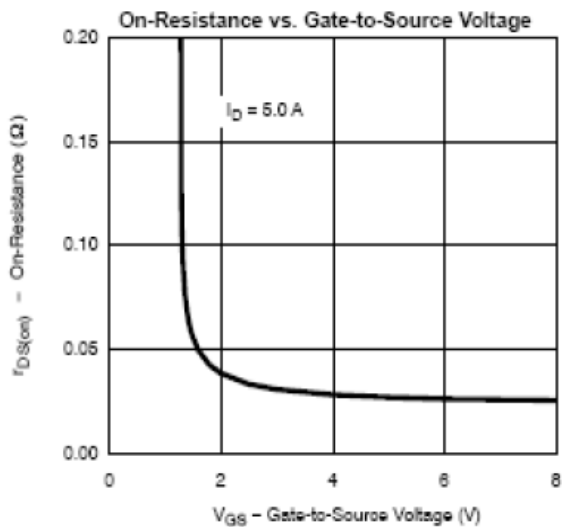
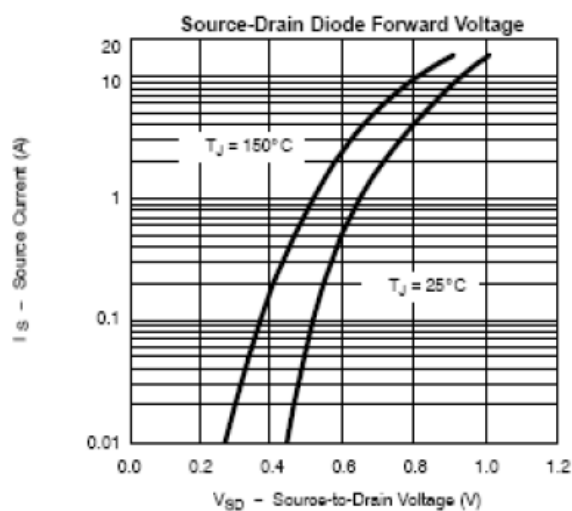
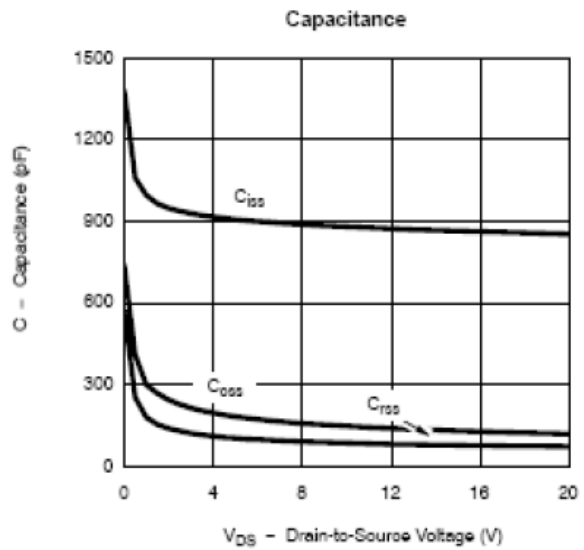
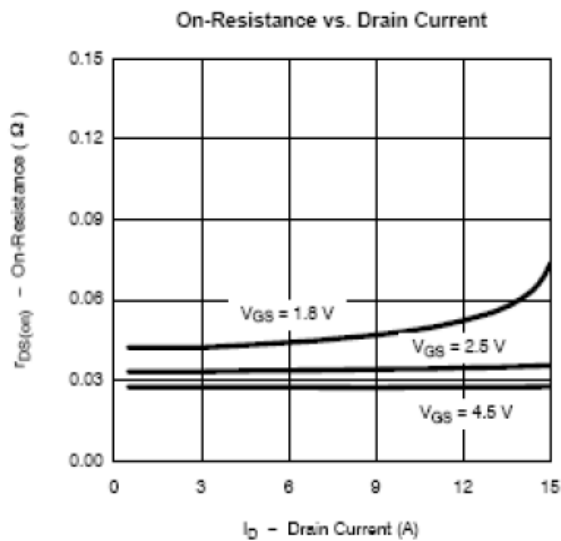
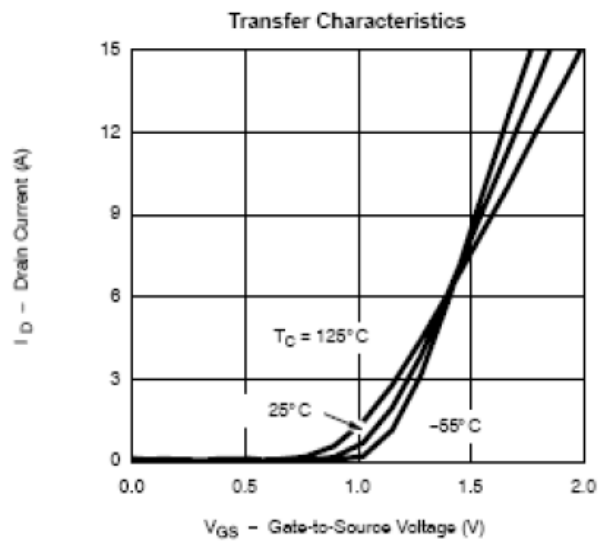
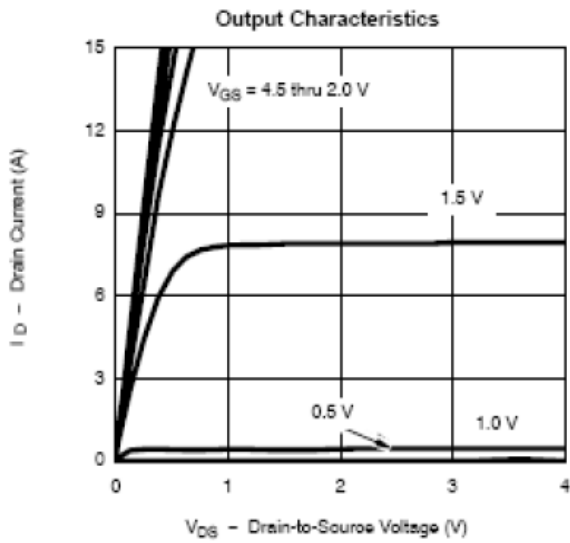

PACKAGE OUTLINE

Plastic surface mounted package; 3 leads

SOT-23

