

HSF

NOTES:

Rated Current:9.0AMP
 Contact Resistance:30mΩ max
 Withstand Voltage:1500V AC/minute
 Insulation Resistance:1000MΩ min
 Operation Temperature:-25℃ to +85℃

Contact Material:Brass
 Contact Plating:Sn Over Ni
 Insulator Material:PA66 White(UL94-V0)

Recommended P.C.B Layout(Top Side)
 (PCB BOARD TOLERANCE±0.05)

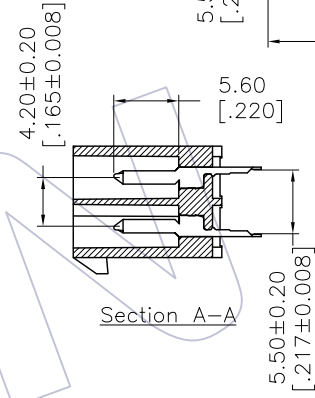
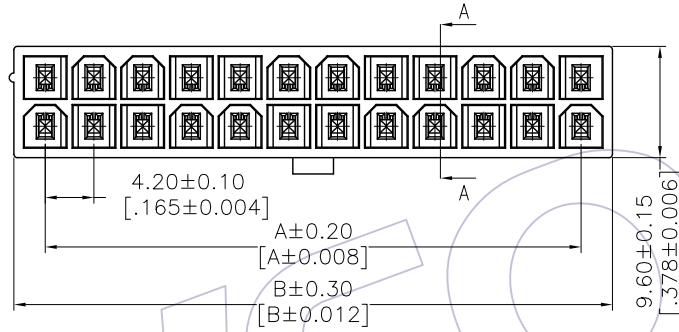
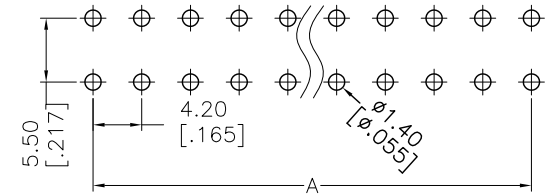

Ordering Information

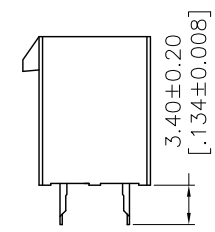
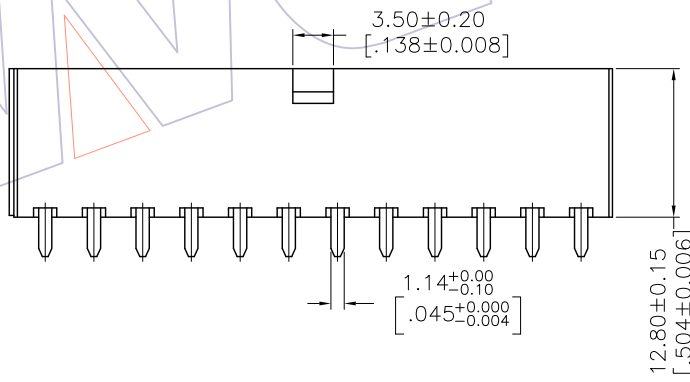
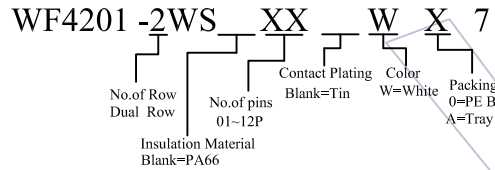

Dimensional & Ordering Information

Circuit	Part No.	Dimension	
		A	B
2x01	WF4201-2WS01WX7	---	5.40
2x02	WF4201-2WS02WX7	4.20	9.60
2x03	WF4201-2WS03WX7	8.40	13.80
2x04	WF4201-2WS04WX7	12.60	18.00
2x05	WF4201-2WS05WX7	16.80	22.20
2x06	WF4201-2WS06WX7	21.00	26.40
2x07	WF4201-2WS07WX7	25.20	30.60
2x08	WF4201-2WS08WX7	29.40	34.80
2x09	WF4201-2WS09WX7	33.60	39.00
2x10	WF4201-2WS10WX7	37.80	43.20
2x11	WF4201-2WS11WX7	42.00	47.40
2x12	WF4201-2WS12WX7	46.20	51.60

OPERATION	DRAW	DATE	SCALE	FIT	PART NO. SEE TAB
X.X ±0.40	Dwg	2017/10/17	UNIT	mm	
X.XX ±0.25	CHECK	DATE	SIZE	A4	TITLE: 4.20 MINI FIT DUAL ROW 180° WITH SHORT BUMP WITHOUT POST
X.XXX ±0.15	APPROVE	DATE	SHEET	1/2	Customer NO.
Angle ± 3'	DIM	TOL	PROJ.	⌀	
AO 2017/10/17	NEW				
REV	DATE	MODIFICATION DESCRIPTION	CHANGE		

WCON
 Http: www.wcon.com

WCON-Dongguan Tel: +86 769 85358920 Fax: +86 769 85358915 E-mail: sales@wcon.com

WCON-Kunshan Tel: +86 512 57468408 Fax: +86 512 57468468 E-mail: salesks@wcon.com

HSF

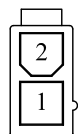

2x01P

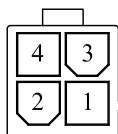

2x02P

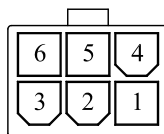

2x03P

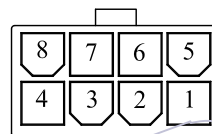

2x04P

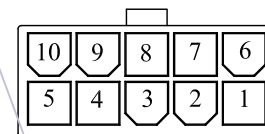

2x05P

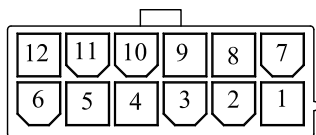

2x06P

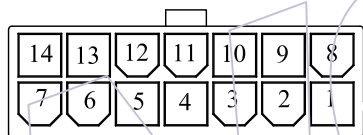

2x07P

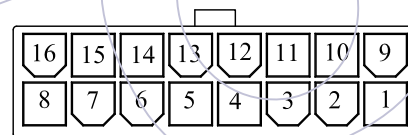

2x08P

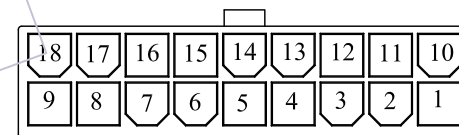

2x09P

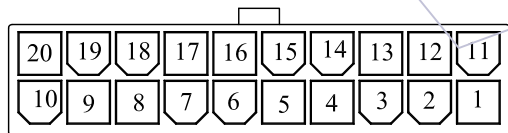

2x10P

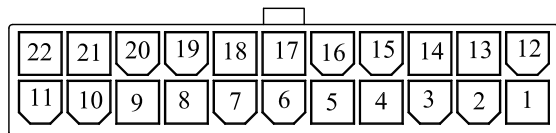

2x11P

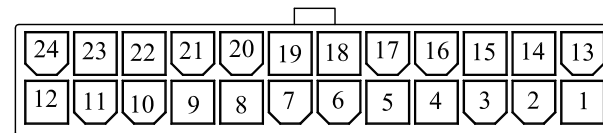

2x12P

				OPERATION	DRAW	DATE	SCALE	FIT	PART NO.	 Http: www.wcon.com
				X.X ±0.40	Ding	2017/10/17	UNIT	mm	WF4201-2WSXXWX7	
				X.XX ±0.25	CHECK	DATE	SIZE	A4	TITLE:	
AO	2017/10/17	NEW	—	X.XXX ±0.15	APPROVE	DATE	SHEET	2/2	4.20 MINI FIT DUAL ROW 180° WITH SHORT BUMP WITHOUT POST	
REV	DATE	MODIFICATION DESCRIPTION	CHANGE	Angle ± 3'			PROJ.	⌀ ↺	Customer NO.	WCON-Dongguan Tel: +86 769 85358920 Fax: +86 769 85358915 E-mail: sales@wcon.com
				DIM TOL						WCON-Kunshan Tel: +86 512 57468408 Fax: +86 512 57468468 E-mail: salesks@wcon.com