

Product Overview

AR0135CS: CMOS Image Sensor, Digital, Global Shutter, 1.2 MP, 1/3"

For complete documentation, see the data sheet.

This 1/3-inch format, 1.2 MP imaging device has been designed to address the challenging requirements of Industrial, consumer and IoT applications. The new global shutter sensor allows the camera to “freeze” fast moving scene data, and ensures effective synchronization with pulsed light sources. The AR0135 sensor incorporates a new innovative global shutter pixel design, with 10X lower dark current and 4X higher shutter efficiency vs. previous generation products. These improvements allow the sensor to produce clear, low-noise images, in both low-light and bright scenes, and in high temperature environments. This performance enables the required eye tracking and gesture detection functionality in 3D scanner, gesture recognition devices.

Features

- ON Semiconductor's Next Generation Global Shutter Technology
- Superior Low-light Performance
- HD Video (720p60)
- Video/Single Frame Mode
- Flexible Row-skip Modes
- On-chip AE and Statistics Engine
- Parallel and Serial Output
- Support for External LED or Flash
- Auto Black Level Calibration
- Context Switching

For more features, see the data sheet

Applications

- Barcode scanner
- 3D scanning
- Positional tracking
- Iris Scanning
- Augmented Reality

Part Electrical Specifications

Product	Pricing (\$/Unit)	Compliance	Status	Type	Megapixels	Frame Rate (fps)	Optical Format	Shutter Type	Pixel Size (µm)	Output Interface	Color	Package Type
AR0135CS2C00SUD20		Pb-free Halide free	Active	CMOS	1.2	1.2MP 54fps, 720P 60fps	1/3 inch	Global Shutter	3.75 x 3.75	Parallel HiSPi™	RGB	
AR0135CS2C00SUEA0 -DPBR		Pb-free Halide free	Active	CMOS	1.2	1.2MP 54fps, 720P 60fps	1/3 inch	Global Shutter	3.75 x 3.75	Parallel HiSPi™	RGB	IBGA-63
AR0135CS2C00SUEA0 -DPBR1		Pb-free Halide free	Active	CMOS	1.2	1.2MP 54fps, 720P 60fps	1/3 inch	Global Shutter	3.75 x 3.75	Parallel HiSPi™	RGB	IBGA-63
AR0135CS2C00SUEA0 -DRBR		Pb-free Halide free	Active	CMOS	1.2	1.2MP 54fps, 720P 60fps	1/3 inch	Global Shutter	3.75 x 3.75	Parallel HiSPi™	RGB	IBGA-63
AR0135CS2C00SUEA0 -DRBR1		Pb-free Halide free	Active	CMOS	1.2	1.2MP 54fps, 720P 60fps	1/3 inch	Global Shutter	3.75 x 3.75	Parallel HiSPi™	RGB	IBGA-63
AR0135CS2C19SUD20		Pb-free Halide free	Active	CMOS	1.2	1.2MP 54fps, 720P 60fps	1/3 inch	Global Shutter	3.75 x 3.75	HiSPi™ Parallel	RGB	
AR0135CS2C19SUEA0 -DPBR		Pb-free Halide free	Active	CMOS	1.2	1.2MP 54fps, 720P 60fps	1/3 inch	Global Shutter	3.75 x 3.75	Parallel HiSPi™	RGB	IBGA-63
AR0135CS2C19SUEA0 -DPBR1		Pb-free Halide free	Active	CMOS	1.2	1.2MP 54fps, 720P 60fps	1/3 inch	Global Shutter	3.75 x 3.75	Parallel HiSPi™	RGB	IBGA-63
AR0135CS2C19SUEA0 -DRBR		Pb-free Halide free	Active	CMOS	1.2	1.2MP 54fps, 720P 60fps	1/3 inch	Global Shutter	3.75 x 3.75	Parallel HiSPi™	RGB	IBGA-63
AR0135CS2C19SUEA0 -DRBR1		Pb-free Halide free	Active	CMOS	1.2	1.2MP 54fps, 720P 60fps	1/3 inch	Global Shutter	3.75 x 3.75	Parallel HiSPi™	RGB	IBGA-63
AR0135CS2M00SUD20		Pb-free Halide free	Active	CMOS	1.2	1.2MP 54fps, 720P 60fps	1/3 inch	Global Shutter	3.75 x 3.75	HiSPi™ Parallel	Mono	
AR0135CS2M00SUEA0 -DPBR		Pb-free Halide free	Active	CMOS	1.2	1.2MP 54fps, 720P 60fps	1/3 inch	Global Shutter	3.75 x 3.75	HiSPi™ Parallel	Mono	IBGA-63
AR0135CS2M00SUEA0 -DPBR1		Pb-free Halide free	Active	CMOS	1.2	1.2MP 54fps, 720P 60fps	1/3 inch	Global Shutter	3.75 x 3.75	HiSPi™ Parallel	Mono	IBGA-63
AR0135CS2M00SUEA0 -DRBR		Pb-free Halide free	Active	CMOS	1.2	1.2MP 54fps, 720P 60fps	1/3 inch	Global Shutter	3.75 x 3.75	HiSPi™ Parallel	Mono	IBGA-63
AR0135CS2M00SUEA0 -DRBR1		Pb-free Halide free	Active	CMOS	1.2	1.2MP 54fps, 720P 60fps	1/3 inch	Global Shutter	3.75 x 3.75	HiSPi™ Parallel	Mono	IBGA-63
AR0135CS2M25SUD20		Pb-free Halide free	Active	CMOS	1.2	1.2MP 54fps, 720P 60fps	1/3 inch	Global Shutter	3.75 x 3.75	Parallel HiSPi™	Mono	
AR0135CS2M25SUEA0 -DPBR		Pb-free Halide free	Active	CMOS	1.2	1.2MP 54fps, 720P 60fps	1/3 inch	Global Shutter	3.75 x 3.75	Parallel HiSPi™	Mono	IBGA-63
AR0135CS2M25SUEA0 -DPBR1		Pb-free Halide free	Active	CMOS	1.2	1.2MP 54fps, 720P 60fps	1/3 inch	Global Shutter	3.75 x 3.75	Parallel HiSPi™	Mono	IBGA-63
AR0135CS2M25SUEA0 -DRBR		Pb-free Halide free	Active	CMOS	1.2	1.2MP 54fps, 720P 60fps	1/3 inch	Global Shutter	3.75 x 3.75	HiSPi™ Parallel	Mono	IBGA-63
AR0135CS2M25SUEA0 -DRBR1		Pb-free Halide free	Active	CMOS	1.2	1.2MP 54fps, 720P 60fps	1/3 inch	Global Shutter	3.75 x 3.75	HiSPi™ Parallel	Mono	IBGA-63
AR0135CS2M25SUEA0 -TPBR		Pb-free Halide free	Active	CMOS	1.2	1.2MP 54fps, 720P 60fps	1/3 inch	Global Shutter	3.75 x 3.75	HiSPi™ Parallel	Mono	IBGA-63
AR0135CS2M25SUEA0 -TRBR		Pb-free Halide free	Active	CMOS	1.2	1.2MP 54fps, 720P 60fps	1/3 inch	Global Shutter	3.75 x 3.75	HiSPi™ Parallel	Mono	IBGA-63

Application Diagram

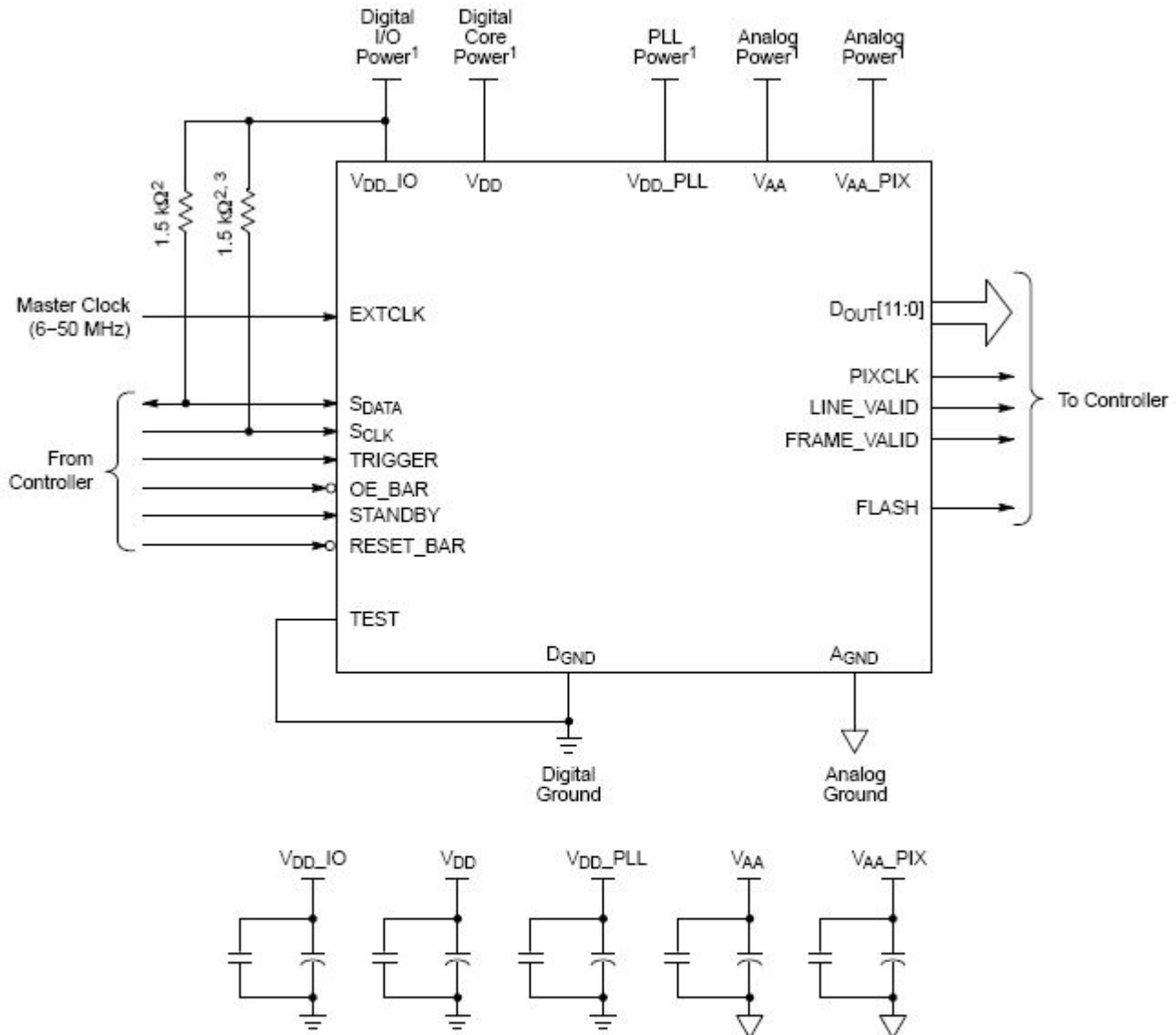

Notes:

1. All power supplies must be adequately decoupled.
2. ON Semiconductor recommends a resistor value of 1.5 kΩ, but a greater value may be used for slower two-wire speed.
3. This pull-up resistor is not required if the controller drives a valid logic level on SCLK at all times.
4. The serial interface output pads can be left unconnected if the parallel output interface is used.
5. ON Semiconductor recommends that 0.1 μF and 10 μF decoupling capacitors for each power supply are mounted as close as possible to the pad. Actual values and results may vary depending on the layout and design considerations. Refer to the AR0135CS demo headboard schematics for circuit recommendations.
6. ON Semiconductor recommends that analog power planes are placed in a manner such that coupling with the digital power planes is minimized.

For more information please contact your local sales support at www.onsemi.com.

Created on: 8/21/2020