



Is Now Part of



**ON Semiconductor®**

To learn more about ON Semiconductor, please visit our website at  
[www.onsemi.com](http://www.onsemi.com)

Please note: As part of the Fairchild Semiconductor integration, some of the Fairchild orderable part numbers will need to change in order to meet ON Semiconductor's system requirements. Since the ON Semiconductor product management systems do not have the ability to manage part nomenclature that utilizes an underscore (\_), the underscore (\_) in the Fairchild part numbers will be changed to a dash (-). This document may contain device numbers with an underscore (\_). Please check the ON Semiconductor website to verify the updated device numbers. The most current and up-to-date ordering information can be found at [www.onsemi.com](http://www.onsemi.com). Please email any questions regarding the system integration to [Fairchild\\_questions@onsemi.com](mailto:Fairchild_questions@onsemi.com).

ON Semiconductor and the ON Semiconductor logo are trademarks of Semiconductor Components Industries, LLC dba ON Semiconductor or its subsidiaries in the United States and/or other countries. ON Semiconductor owns the rights to a number of patents, trademarks, copyrights, trade secrets, and other intellectual property. A listing of ON Semiconductor's product/patent coverage may be accessed at [www.onsemi.com/site/pdf/Patent-Marking.pdf](http://www.onsemi.com/site/pdf/Patent-Marking.pdf). ON Semiconductor reserves the right to make changes without further notice to any products herein. ON Semiconductor makes no warranty, representation or guarantee regarding the suitability of its products for any particular purpose, nor does ON Semiconductor assume any liability arising out of the application or use of any product or circuit, and specifically disclaims any and all liability, including without limitation special, consequential or incidental damages. Buyer is responsible for its products and applications using ON Semiconductor products, including compliance with all laws, regulations and safety requirements or standards, regardless of any support or applications information provided by ON Semiconductor. "Typical" parameters which may be provided in ON Semiconductor data sheets and/or specifications can and do vary in different applications and actual performance may vary over time. All operating parameters, including "Typicals" must be validated for each customer application by customer's technical experts. ON Semiconductor does not convey any license under its patent rights nor the rights of others. ON Semiconductor products are not designed, intended, or authorized for use as a critical component in life support systems or any FDA Class 3 medical devices or medical devices with a same or similar classification in a foreign jurisdiction or any devices intended for implantation in the human body. Should Buyer purchase or use ON Semiconductor products for any such unintended or unauthorized application, Buyer shall indemnify and hold ON Semiconductor and its officers, employees, subsidiaries, affiliates, and distributors harmless against all claims, costs, damages, and expenses, and reasonable attorney fees arising out of, directly or indirectly, any claim of personal injury or death associated with such unintended or unauthorized use, even if such claim alleges that ON Semiconductor was negligent regarding the design or manufacture of the part. ON Semiconductor is an Equal Opportunity/Affirmative Action Employer. This literature is subject to all applicable copyright laws and is not for resale in any manner.



2015 年 4 月

# FCD850N80Z / FCU850N80Z

## N- 沟道 SuperFET<sup>®</sup> II MOSFET

800 V, 6 A, 850 mΩ

### 特性

- 典型值  $R_{DS(on)} = 710 \text{ m}\Omega$  (典型值)
- 超低栅极电荷 (典型值  $Q_g = 22 \text{ nC}$ )
- 低  $E_{oss}$  (典型值  $2.3 \text{ uJ @ } 400 \text{ V}$ )
- 低有效输出电容 (典型值  $C_{oss(eff.)} = 106 \text{ pF}$ )
- 100% 经过雪崩测试
- 符合 RoHS 标准
- 增强的 ESD 能力

### 描述

SuperFET<sup>®</sup> II MOSFET 是飞兆利用电荷平衡技术实现出色的低导通电阻和更低栅极电荷性能的全新高压超级结 (SJ) MOSFET 系列产品。这项技术专用于最小化导通损耗并提供卓越的开关性能、dv/dt 额定值和更高雪崩能量。此外，内部栅源极 ESD 二极管允许经受超过 2 kV HBM 冲击压力。因此，SuperFET II MOSFET 非常适合功率开关应用，如音频、笔记本适配器、照明、ATX 电源和工业电源应用。

### 应用

- AC-DC 电源
- LED 照明

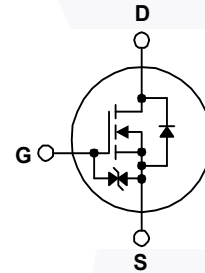
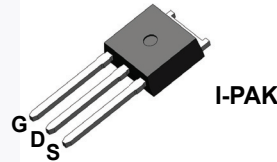
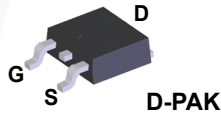

**最大绝对额定值**  $T_C = 25^\circ\text{C}$  除非另有说明。

符号	参数		FCD850N80Z FCU850N80Z	单位
$V_{DSS}$	漏极 - 源极电压		800	V
$V_{GSS}$	栅极 - 源极电压	- DC	$\pm 20$	V
		- AC ( $f > 1 \text{ Hz}$ )	$\pm 30$	
$I_D$	漏极电流	- 连续 ( $T_C = 25^\circ\text{C}$ )	6	A
		- 连续 ( $T_C = 100^\circ\text{C}$ )	3.8	
$I_{DM}$	漏极电流	- 脉冲 (注 1)	18	A
$E_{AS}$	单脉冲雪崩能量	(注 2)	114	mJ
$I_{AR}$	雪崩电流	(注 1)	1.2	A
$E_{AR}$	重复雪崩能量	(注 1)	0.284	mJ
dv/dt	MOSFET dv/dt		100	V/ns
	二极管恢复 dv/dt 峰值 (注 3)		20	
$P_D$	功耗	( $T_C = 25^\circ\text{C}$ )	75	$\Omega$
		- 高于 $25^\circ\text{C}$ 的功耗系数	0.6	$\text{W}/^\circ\text{C}$
$T_J, T_{STG}$	工作和存储温度范围		-55 至 +150	$^\circ\text{C}$
$T_L$	用于焊接的最大引脚温度，距离外壳 1/8"，持续 5 秒		300	$^\circ\text{C}$

### 热性能

符号	参数	FCD850N80Z FCU850N80Z	单位
$R_{\theta JC}$	结至外壳热阻最大值	1.65	$^\circ\text{C}/\text{W}$
$R_{\theta JA}$	结至环境热阻最大值	100	

FCD850N80Z / FCU850N80Z — N-沟道 SuperFET<sup>®</sup> II MOSFET

## 封装标识与订购信息

器件编号	顶标	封装	包装方法	卷尺寸	带宽	数量
FCD850N80Z	FCD850N80Z	DPAK	卷带	330 mm	16 mm	2500 颗
FCU850N80Z	FCU850N80Z	IPAK	塑料管	不适用	不适用	75 个

电气特性  $T_C = 25^\circ\text{C}$  除非另有说明。

符号	参数	测试条件	最小值	典型值	最大值	单位
----	----	------	-----	-----	-----	----

## 关断特性

$BV_{DSS}$	漏极-源极击穿电压	$V_{GS} = 0\text{ V}, I_D = 1\text{ mA}, T_J = 25^\circ\text{C}$	800	-	-	V
$\Delta BV_{DSS} / \Delta T_J$	击穿电压温度系数	$I_D = 1\text{ mA}$ , 参考 $25^\circ\text{C}$ 数值	-	0.8	-	$\text{V}/^\circ\text{C}$
$I_{DSS}$	零栅极电压漏极电流	$V_{DS} = 800\text{ V}, V_{GS} = 0\text{ V}$	-	-	25	$\mu\text{A}$
		$V_{DS} = 640\text{ V}, V_{GS} = 0\text{ V}, T_C = 125^\circ\text{C}$	-	-	250	
$I_{GSS}$	栅极-体漏电流	$V_{GS} = \pm 20\text{ V}, V_{DS} = 0\text{ V}$	-	-	$\pm 10$	$\mu\text{A}$

## 导通特性

$V_{GS(th)}$	栅极阈值电压	$V_{GS} = V_{DS}, I_D = 0.6\text{ mA}$	2.5	-	4.5	V
$R_{DS(on)}$	漏极至源极静态导通电阻	$V_{GS} = 10\text{ V}, I_D = 3\text{ A}$	-	710	850	$\text{m}\Omega$
$g_{FS}$	正向跨导	$V_{DS} = 20\text{ V}, I_D = 3\text{ A}$	-	3.5	-	S

## 动态特性

$C_{iss}$	输入电容	$V_{DS} = 100\text{ V}, V_{GS} = 0\text{ V}, f = 1\text{ MHz}$	-	990	1315	$\text{pF}$
$C_{oss}$	输出电容		-	28	37	$\text{pF}$
$C_{rss}$	反向传输电容		-	0.74	-	$\text{pF}$
$C_{oss}$	输出电容	$V_{DS} = 480\text{ V}, V_{GS} = 0\text{ V}, f = 1\text{ MHz}$	-	15	-	$\text{pF}$
$C_{oss(eff.)}$	有效输出电容	$V_{DS} = 0\text{ V}$ 至 $480\text{ V}, V_{GS} = 0\text{ V}$	-	106	-	$\text{pF}$
$Q_{g(tot)}$	10 V 的栅极电荷总量	$V_{DS} = 640\text{ V}, I_D = 6\text{ A}, V_{GS} = 10\text{ V}$	-	22	29	$\text{nC}$
$Q_{gs}$	栅极-源极栅极电荷		-	5	-	$\text{nC}$
$Q_{gd}$	栅极-漏极“米勒”电荷		(注 4)	-	8.6	-
ESR	等效串联电阻	$f = 1\text{ MHz}$	-	2.4	-	$\Omega$

## 开关特性

$t_{d(on)}$	导通延迟时间	$V_{DD} = 400\text{ V}, I_D = 6\text{ A}, V_{GS} = 10\text{ V}, R_g = 4.7\ \Omega$	-	16	42	ns
$t_r$	开通上升时间		-	10	30	ns
$t_{d(off)}$	关断延迟时间		-	40	90	ns
$t_f$	关断下降时间		(注 4)	-	4.5	19

## 漏极-源极二极管特性

$I_S$	漏极-源极二极管最大正向连续电流	-	-	6	A	
$I_{SM}$	漏极-源极二极管最大正向脉冲电流	-	-	18	A	
$V_{SD}$	漏极-源极二极管正向电压	$V_{GS} = 0\text{ V}, I_{SD} = 6\text{ A}$	-	-	1.2	V
$t_{rr}$	反向恢复时间	$V_{GS} = 0\text{ V}, I_{SD} = 6\text{ A}, di_F/dt = 100\text{ A}/\mu\text{s}$	-	318	-	ns
$Q_{rr}$	反向恢复电荷		-	4.5	-	$\mu\text{C}$

## 注:

- 重复额定值: 脉冲宽度受限于最大结温。
- $I_{AS} = 1.2\text{ A}, V_{DD} = 50\text{ V}, R_G = 25\ \Omega$ , 开始于  $T_J = 25^\circ\text{C}$
- $I_{SD} \leq 6\text{ A}, di/dt \leq 200\text{ A}/\mu\text{s}, V_{DD} \leq BV_{DSS}$ , 开始于  $T_J = 25^\circ\text{C}$
- 典型特性本质上独立于工作温度。

## 典型性能特征

图 1. 导通区域特性



图 2. 传输特性



图 3. 导通电阻变化与漏极电流和栅极电压的关系

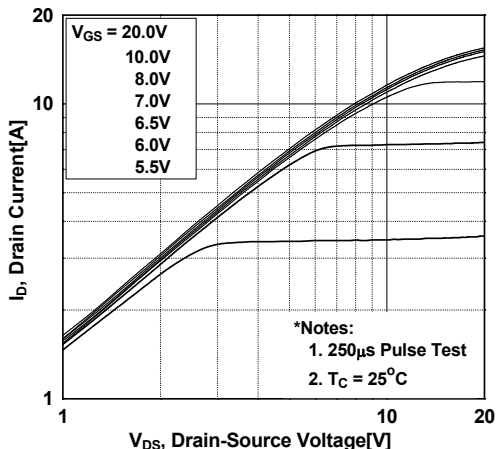

图 4. 体二极管正向电压变化与源极电流和温度的关系

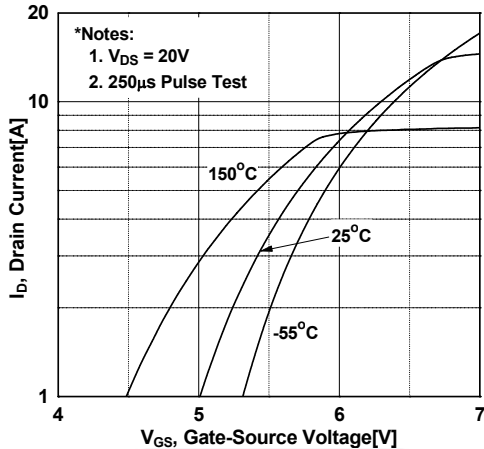

图 5. 电容特性

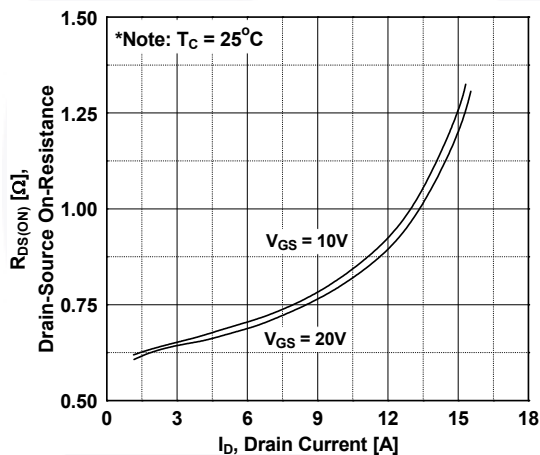

图 6. 栅极电荷特性

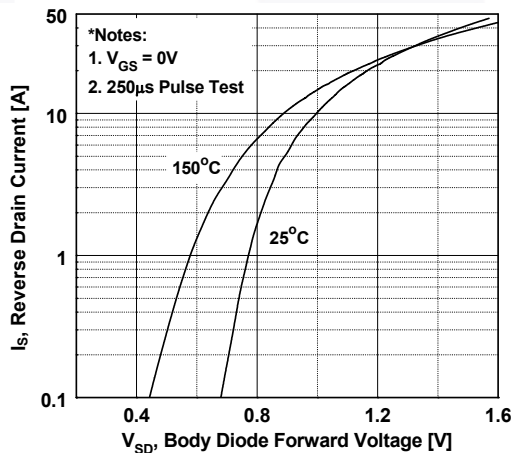

典型性能特征 (接上页)

图 7. 击穿电压变化与温度的关系

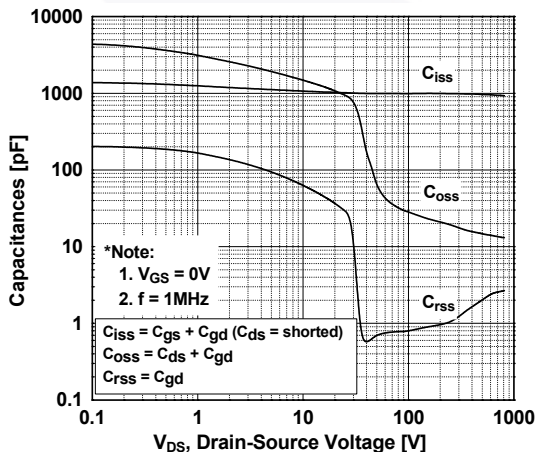
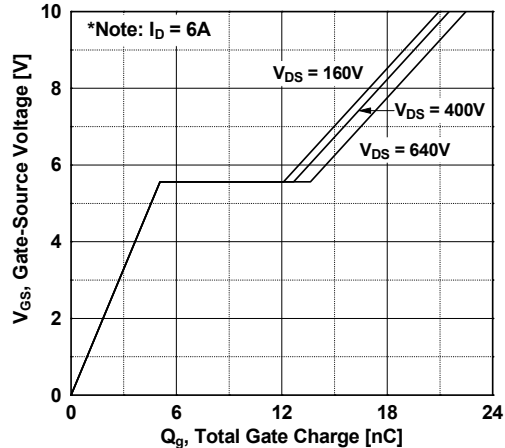

图 8. 导通电阻变化与温度的关系



图 9. 最大安全工作区

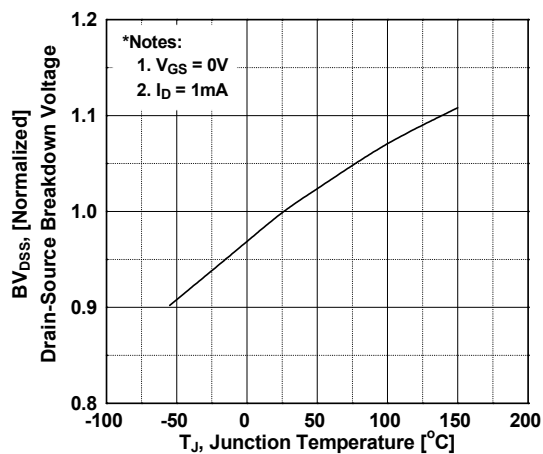

图 10. 最大漏极电流与壳温的关系

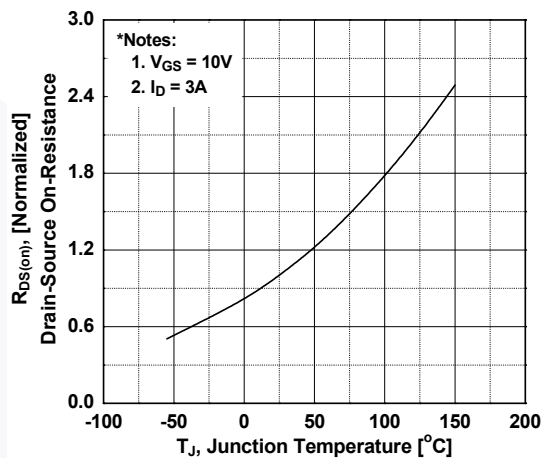

图 11. E\_oss 与漏源极电压的关系

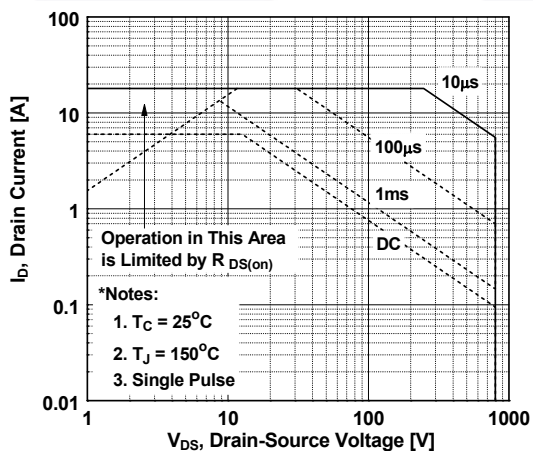

典型性能特征 (接上页)

图 12. 瞬态热响应曲线

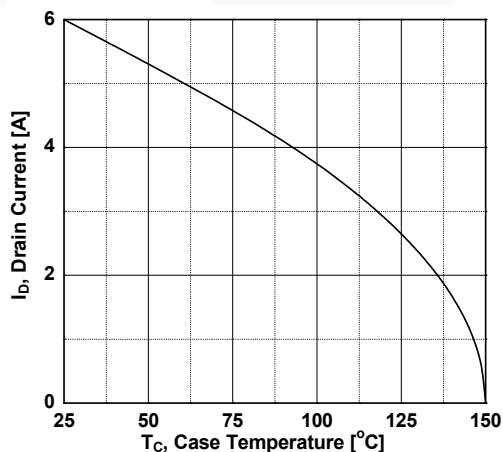
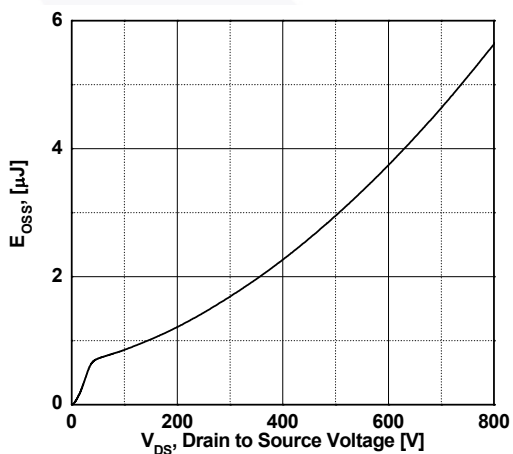
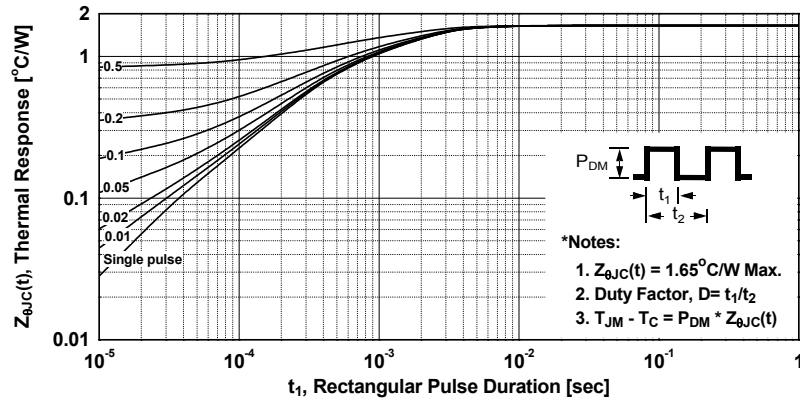



图 13. 栅极电荷测试电路与波形



图 14. 阻性开关测试电路与波形

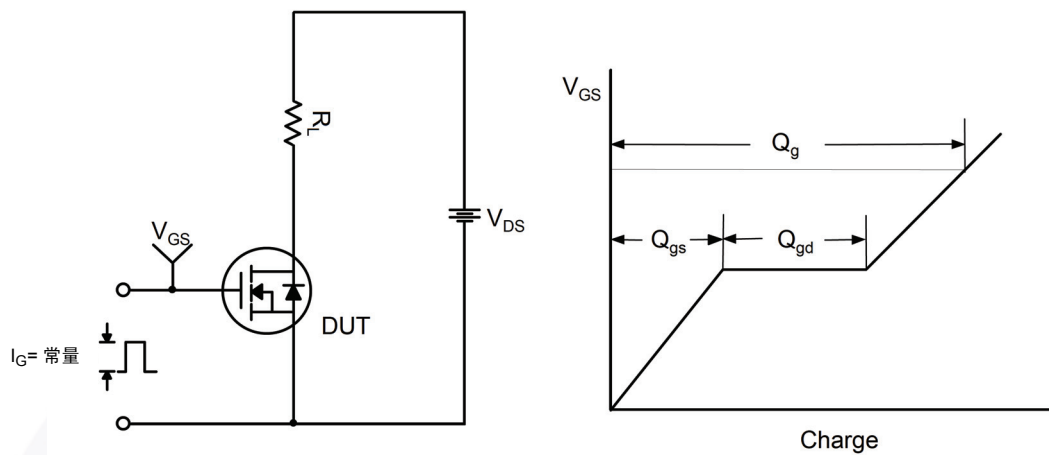

图 15. 非箝位电感开关测试电路与波形

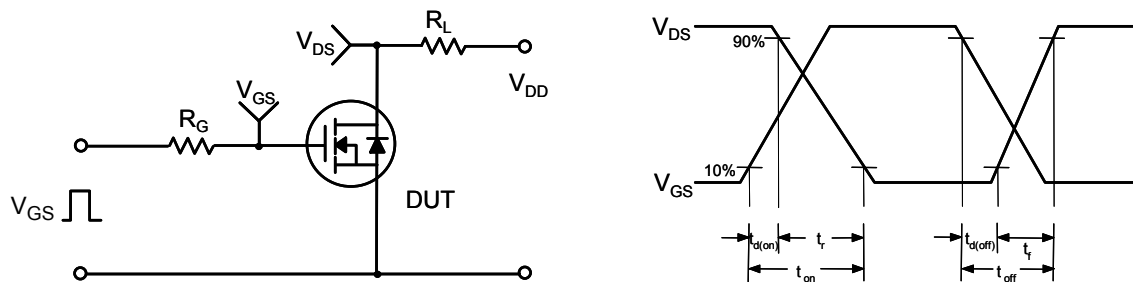

图 16. 二极管恢复  $dv/dt$  峰值测试电路与波形

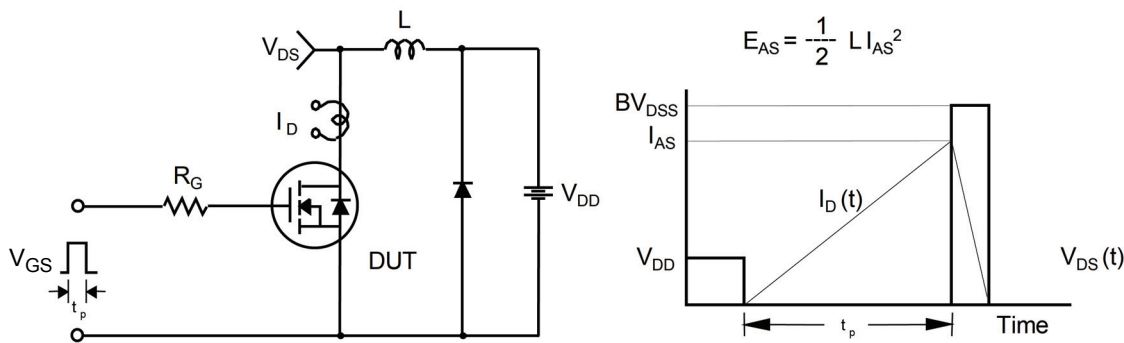

## 机械尺寸

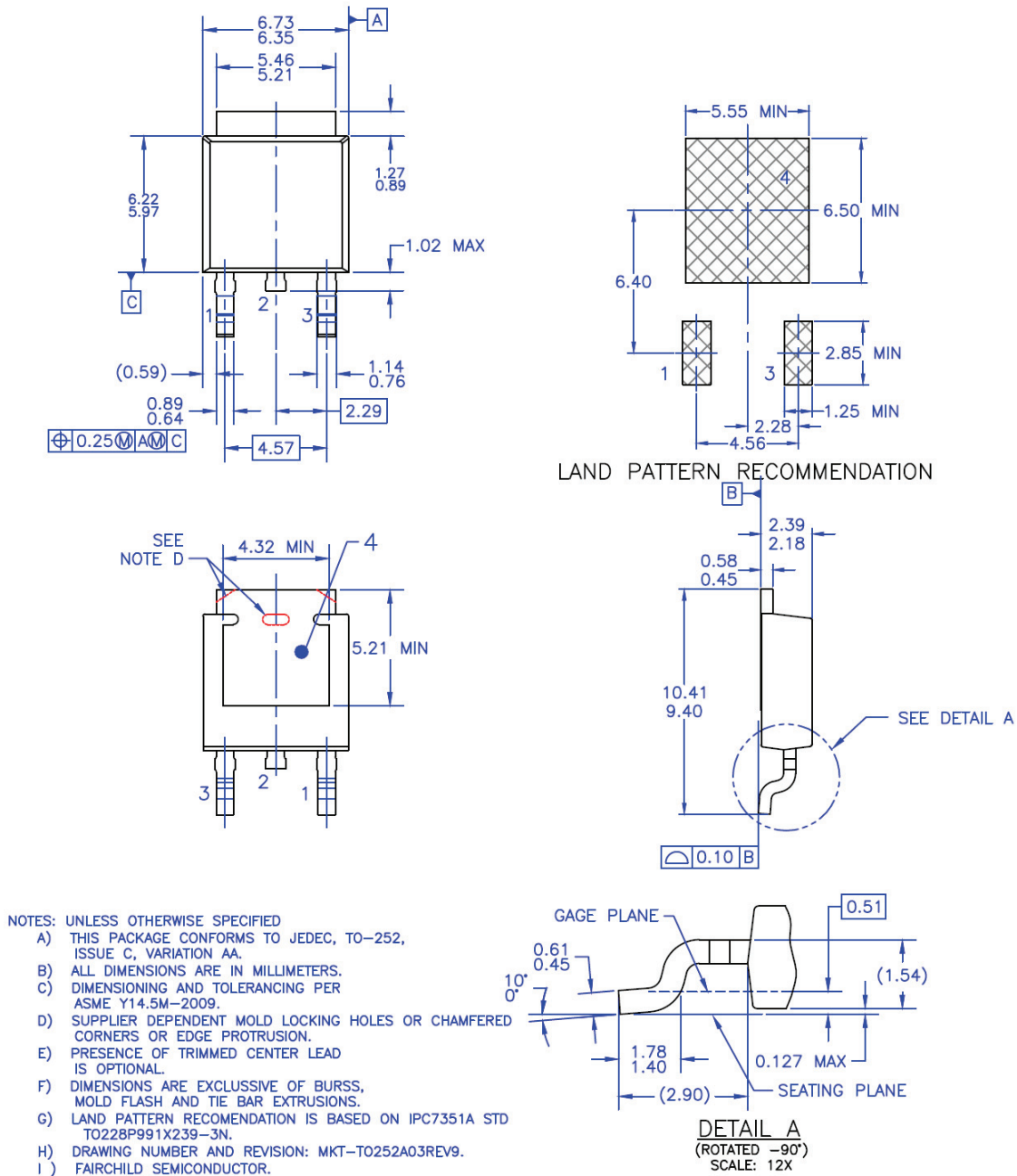

**图 17. TO252 (D-PAK), 模塑 3 引脚, Jedec 变体 AA&AB**

封装图纸作为一项服务, 提供给考虑飞兆半导体元件的客户。具体参数可能会有变化, 且不会做出相应通知。请注意图纸上的版本和 / 或日期, 并联系飞兆半导体代表核实或获得最新版本。封装规格并不扩大飞兆半导体全球范围内的条款与条件, 尤其是其中涉及飞兆半导体产品保修的部分。

随时访问飞兆半导体在线封装网页, 可以获取最新的封装图纸:

[http://www.fairchildsemi.com/package/packageDetails.html?id=PN\\_TT252-003](http://www.fairchildsemi.com/package/packageDetails.html?id=PN_TT252-003)

机械尺寸



图 18. TO251 (I-PAK), 模塑 3 引脚, 变体 AA

封装图纸作为一项服务, 提供给考虑飞兆半导体元件的客户。具体参数可能会有变化, 且不会做出相应通知。请注意图纸上的版本和 / 或日期, 并联系飞兆半导体代表核实或获得最新版本。封装规格并不扩大飞兆半导体全球范围内的条款与条件, 尤其是其中涉及飞兆半导体产品保修的部分。

随时访问飞兆半导体在线封装网页, 可以获取最新的封装图纸:

[http://www.fairchildsemi.com/package/packageDetails.html?id=PN\\_TT251-003](http://www.fairchildsemi.com/package/packageDetails.html?id=PN_TT251-003)

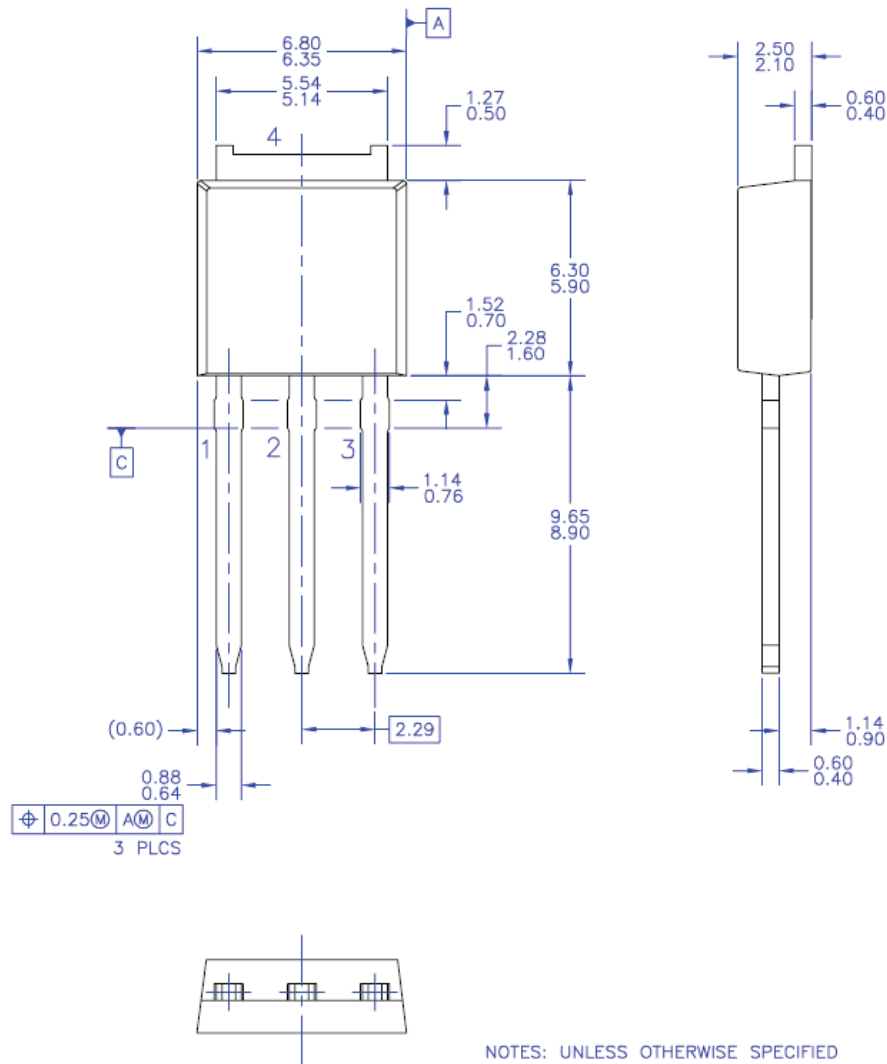

**商标**

以下注册及未注册的商标或服务标志均为飞兆半导体公司和 / 或其全球子公司所有，且并非所有该类商标的完整目录。

- |                          |   |                             |                  |
|--------------------------|---|-----------------------------|------------------|
| AccuPower™               | F-PFS™  | PowerTrench®                | SYSTEM®          |
| AX-CAP®*                 | FRFET®  | PowerXS™                    | GENERAL          |
| BitSiC™                  | Global Power ResourceSM                         | Programmable Active Droop™  | TinyBoost®       |
| Build it Now™            | GreenBridge™                                    | QFET®                       | TinyBuck®        |
| CorePLUS™                | Green FPS™                                      | QS™                         | TinyCalc™        |
| CorePOWER™               | Green FPS™ e-Series™                            | Quiet Series™               | TinyLogic®       |
| CROSSVOLT™               | Gmax™   | RapidConfigure™             | TINYOPTO™        |
| CTL™                     | GTO™  | SMART START™                | TinyPower™       |
| Current Transfer Logic™  | IntelliMAX™                                     | Solutions for Your Success™ | TinyPWM™         |
| DEUXPEED®                | ISOPLANAR™                                      | SPM®                        | TinyWire™        |
| Dual Cool™               | Marking Small Speakers Sound Louder and Better™ | STEALTH™                    | TranSiC™         |
| EcoSPARK®                | MegaBuck™                                       | SuperFET®                   | TriFault Detect™ |
| EfficientMax™            | MICROCOUPLER™                                   | SuperSOT™-3                 | TRUECURRENT®*    |
| ESBC™                    | MicroFET™                                       | SuperSOT™-6                 | μSerDes™         |
| <b>F</b> ®               | MicroPak™                                       | SuperSOT™-8                 | <b>μ</b> SerDes™ |
| Fairchild®               | MicroPak2™                                      | SupreMOS®                   | UHC®             |
| Fairchild Semiconductor® | MillerDrive™                                    | SyncFET™                    | Ultra FRFET®     |
| FACT Quiet Series™       | MotionMax™                                      | Sync-Lock™                  | UniFET™          |
| FACT®                    | mWSaver®  |                             | VCX™             |
| FAST®                    | OptoHiT™  |                             | VisualMax™       |
| FastvCore™               | OPTOLOGIC®                                      |                             | VoltagePlus™     |
| FETBench™                | OPTOPLANAR®                                     |                             | XS™              |
| FPS™                     |   |                             | 仙童™              |

\* 商标为 System General Corporation 所有，授权飞兆半导体公司使用。

**声明**

飞兆半导体公司为提高产品的可靠性、功能或设计，保留对其作出变动的权利，恕不另行通知。对于本文描述的任何产品和电路在应用中所出现的问题，飞兆半导体公司不承担任何责任；不转让其专利权下的任何许可证，也不转让其他权利。本文中的各项规格说明特定用于本文所述之产品，其保修条款仅用于本文相关产品，不适用于飞兆半导体全球销售的其他产品。

**使用寿命条款**

若无飞兆半导体公司正式的书面授权，其产品不可作为生命支持设备或系统中的关键器件。

具体如下：

1. 生命支持器件或系统是指如下的设备或系统 (a) 用于外科植入人体，或 (b) 支持或维持生命，以及 (c) 即使依照标示中的使用说明进行正确操作，但若操作失败，仍将对使用者造成严重的伤害。
2. 关键器件是指生命支持设备或系统中，由于该器件的失效会导致整个生命支持设备或系统的失效，或是影响其安全性及使用效果。

**防伪条款**

飞兆半导体防伪条款。飞兆半导体防伪条款也在我们的外部网站 [www.fairchildsemi.com](http://www.fairchildsemi.com) “销售支持” 部分清楚列明。

半导体产品的仿造行为在行业内已日趋严重。所有半导体产品制造商都正遭遇其零部件被仿造的问题。无意间购买到假冒零部件的客户遇到很多问题，如品牌声誉损失、性能不合格、应用失败、生产成本增加和制造延误增多等。飞兆半导体正在采取强有力的措施，保护自己并防止客户购买到仿造零部件。飞兆半导体强烈鼓励客户直接从飞兆半导体或其网页所列国家 / 地区的授权分销商处购买飞兆半导体的产品。客户直接从飞兆半导体公司或从其授权分销商购买到的产品都是正品。这些产品具有全面的可追溯性，符合飞兆半导体的质量标准，便于操作和存储，并提供飞兆半导体完整、最新的技术和产品信息的获取途径。飞兆半导体公司及其授权分销商将做好所有保修工作，并妥善处理可能出现的任何保修问题。对于从非授权分销商购买的零部件，飞兆半导体将不提供任何保修或其他援助。飞兆半导体致力于打击这一全球性问题，并鼓励客户尽力通过直接购买或从授权分销商购买的方式阻止产品仿造行为。

**产品状态定义  
术语定义**

数据表标识	产品状态	定义
預告	初级阶段 / 设计阶段	数据表包含了产品开发的设计规格。具体参数可进行改动，且无需做出相应通知。
初级	样品	该数据表包含了初始数据，补充数据随后发布。飞兆半导体保留在任何时间为改进设计而做出更改，且无需另行通知的权力。
无需标识	量产	该数据表包含了最终的技术规范。飞兆半导体保留在任何时间为改进设计而做出更改，且无需另行通知的权力。
废弃	停产	数据手册包含飞兆半导体已停产产品的规格数据。该数据表信息仅供参考。

ON Semiconductor and  are trademarks of Semiconductor Components Industries, LLC dba ON Semiconductor or its subsidiaries in the United States and/or other countries. ON Semiconductor owns the rights to a number of patents, trademarks, copyrights, trade secrets, and other intellectual property. A listing of ON Semiconductor's product/patent coverage may be accessed at [www.onsemi.com/site/pdf/Patent-Marking.pdf](http://www.onsemi.com/site/pdf/Patent-Marking.pdf). ON Semiconductor reserves the right to make changes without further notice to any products herein. ON Semiconductor makes no warranty, representation or guarantee regarding the suitability of its products for any particular purpose, nor does ON Semiconductor assume any liability arising out of the application or use of any product or circuit, and specifically disclaims any and all liability, including without limitation special, consequential or incidental damages. Buyer is responsible for its products and applications using ON Semiconductor products, including compliance with all laws, regulations and safety requirements or standards, regardless of any support or applications information provided by ON Semiconductor. "Typical" parameters which may be provided in ON Semiconductor data sheets and/or specifications can and do vary in different applications and actual performance may vary over time. All operating parameters, including "Typicals" must be validated for each customer application by customer's technical experts. ON Semiconductor does not convey any license under its patent rights nor the rights of others. ON Semiconductor products are not designed, intended, or authorized for use as a critical component in life support systems or any FDA Class 3 medical devices or medical devices with a same or similar classification in a foreign jurisdiction or any devices intended for implantation in the human body. Should Buyer purchase or use ON Semiconductor products for any such unintended or unauthorized application, Buyer shall indemnify and hold ON Semiconductor and its officers, employees, subsidiaries, affiliates, and distributors harmless against all claims, costs, damages, and expenses, and reasonable attorney fees arising out of, directly or indirectly, any claim of personal injury or death associated with such unintended or unauthorized use, even if such claim alleges that ON Semiconductor was negligent regarding the design or manufacture of the part. ON Semiconductor is an Equal Opportunity/Affirmative Action Employer. This literature is subject to all applicable copyright laws and is not for resale in any manner.

## PUBLICATION ORDERING INFORMATION

### LITERATURE FULFILLMENT:

Literature Distribution Center for ON Semiconductor  
19521 E. 32nd Pkwy, Aurora, Colorado 80011 USA  
**Phone:** 303-675-2175 or 800-344-3860 Toll Free USA/Canada  
**Fax:** 303-675-2176 or 800-344-3867 Toll Free USA/Canada  
**Email:** [orderlit@onsemi.com](mailto:orderlit@onsemi.com)

**N. American Technical Support:** 800-282-9855 Toll Free  
USA/Canada  
**Europe, Middle East and Africa Technical Support:**  
Phone: 421 33 790 2910  
**Japan Customer Focus Center**  
Phone: 81-3-5817-1050

**ON Semiconductor Website:** [www.onsemi.com](http://www.onsemi.com)  
**Order Literature:** <http://www.onsemi.com/orderlit>  
For additional information, please contact your local  
Sales Representative