

SURFACE MOUNT SUPER FAST RECOVERY RECTIFIER

PINNING

PIN	DESCRIPTION
1	Cathode
2	Anode

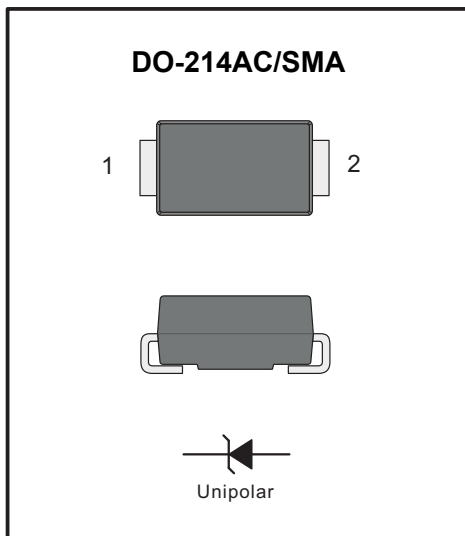

Features

- ◆ The plastic package carries Underwriters Laboratory Flammability Classification 94V-0
- ◆ For surface mounted applications
- ◆ Low reverse leakage
- ◆ Built-in strain relief, ideal for automated placement
- ◆ High forward surge current capability
- ◆ High temperature soldering guaranteed: 250°C/10 seconds at terminals
- ◆ Glass passivated chip junction

Mechanical Data

- ◆ **Case** : JEDEC DO-214AC/SMA Molded plastic body
- ◆ **Terminals** : Solder plated, solderable per MIL-STD-750, Method 2026
- ◆ **Polarity** : Polarity symbol marking on body
- ◆ **Mounting Position** : Any
- ◆ **Weight** : 0.002 ounce, 0.055 grams

Maximum Ratings And Electrical Characteristics

Ratings at 25°C ambient temperature unless otherwise specified.

Single phase half-wave 60Hz, resistive or inductive load, for capacitive load current derate by 20%.

Parameter	SYMBOLS	ES1A	ES1B	ES1C	ES1D	ES1E	ES1G	ES1J	UNITS
Maximum repetitive peak reverse voltage	V_{RRM}	50	100	150	200	300	400	600	V
Maximum RMS voltage	V_{RMS}	35	70	105	140	210	280	420	V
Maximum DC blocking voltage	V_{DC}	50	100	150	200	300	400	600	V
Maximum average forward rectified current at $T_L=55^\circ\text{C}$	$I_{(AV)}$	1.0							A
Peak forward surge current 8.3ms single half sine-wave superimposed on rated load (JEDEC Method)	I_{FSM}	30							A
Maximum instantaneous forward voltage at 1.0A	V_F	0.95			1.25		1.7		V
Maximum DC reverse current at rated DC blocking voltage $T_A=25^\circ\text{C}$ $T_A=125^\circ\text{C}$	I_R	5 50							μA
Maximum reverse recovery time (NOTE 1)	t_{rr}	35							ns
Typical junction capacitance (NOTE 2)	C_J	15.0							pF
Typical thermal resistance (NOTE 3)	$R_{\theta JA}$	60.0							$^\circ\text{C}/\text{W}$
Operating junction and storage temperature range	T_J, T_{STG}	-55 to +150							$^\circ\text{C}$

Note: 1. Reverse recovery condition $I_F=0.5\text{A}, I_R=1.0\text{A}, I_{rr}=0.25\text{A}$
 2. Measured at 1MHz and applied reverse voltage of 4.0V D.C.
 3. P.C.B. mounted with 0.2x0.2" (5.0x5.0mm) copper pad areas

Fig.1 Reverse Recovery Time Characteristic And Test Circuit Diagram

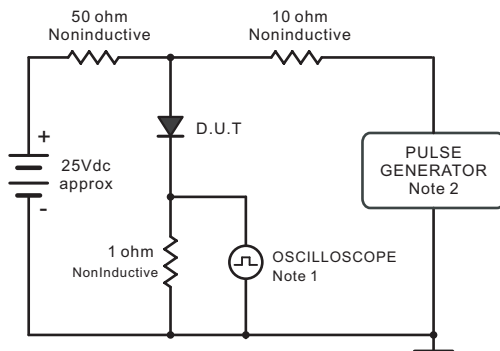

Note: 1. Rise Time = 7ns, max.
Input Impedance = 1megohm, 22pF.
2. Rises Time = 10ns, max.
Source Impedance = 50 ohms.

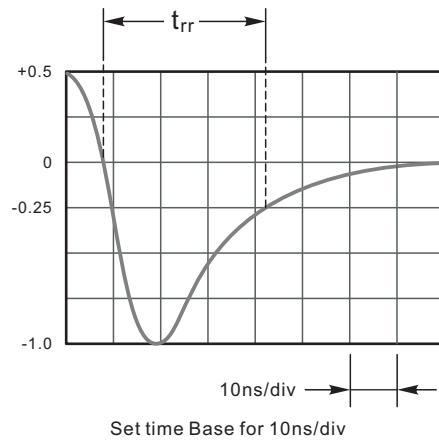

Fig.2 Maximum Average Forward Current Rating

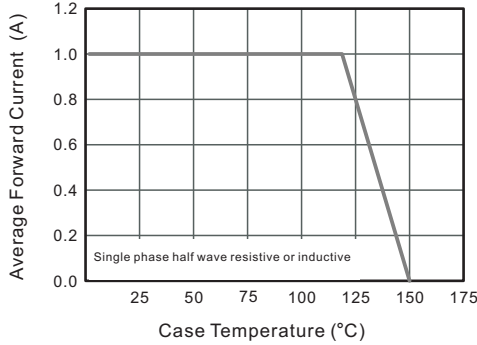

Fig.3 Typical Reverse Characteristics

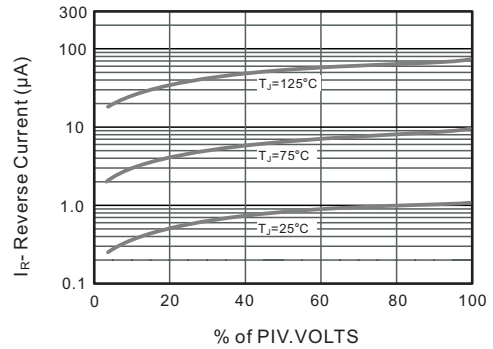

Fig.4 Typical Forward Characteristics

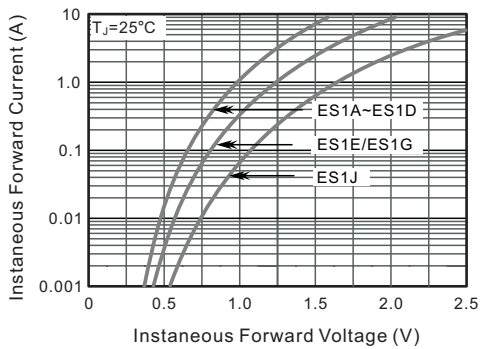

Fig.5 Typical Junction Capacitance

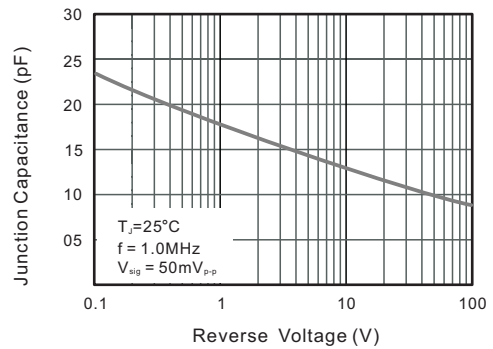
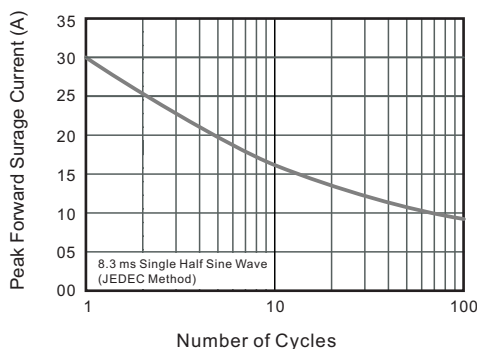

Fig.6 Maximum Non-Repetitive Peak Forward Surge Current



PACKAGE OUTLINE

Plastic surface mounted package; 2 leads

SMA

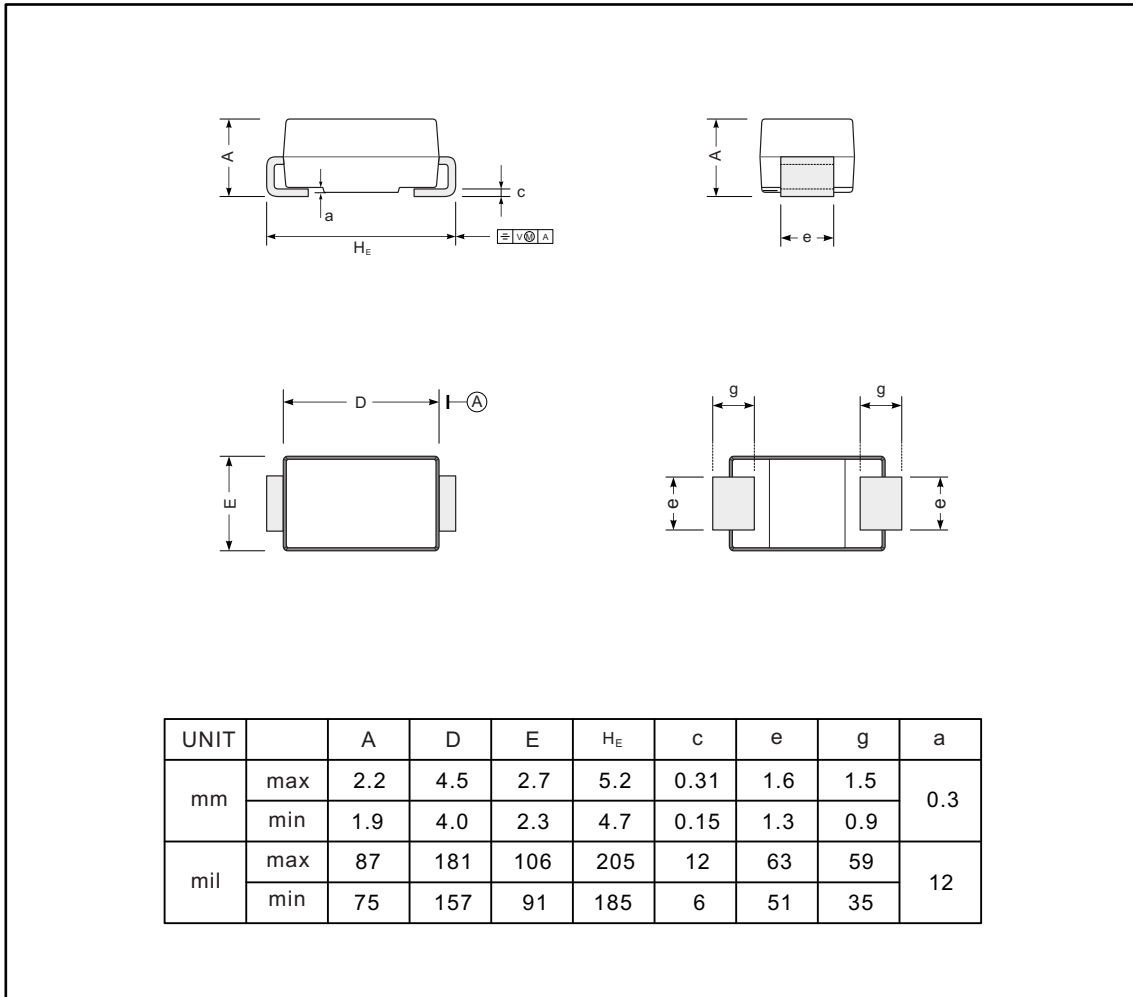

The recommended mounting pad size

