

VL CONNECTOR

6.2mm pitch/Disconnectable Crimp style connectors

(Combined use for both wire-to-board and wire-to-wire connections)

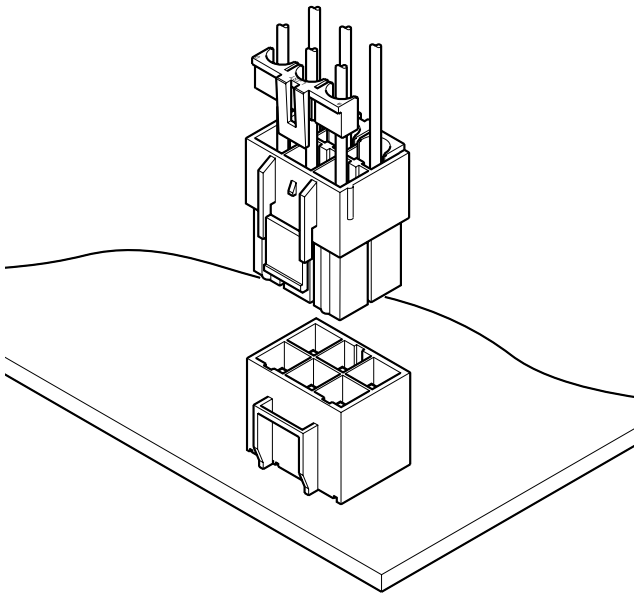

This VL connector is 6.2 mm pitch wire-to-wire and wire-to-board connector, designed for large current. Secondary retainer, which prevents from insufficient insertion of contact and coming off contact, may use and large current circuit can be connected certainly and safety.

- Housing lances
- Retainer
- Suited for large current
- Compatible for both wire-to-wire and wire-to-board connections

Specifications

- Current rating: 20 A AC, DC (Refer to the following table.)
- Voltage rating: 600 V AC, DC
- Temperature range: -25°C to +90°C
(including temperature rise in applying electrical current)
- Contact resistance: Initial value/ 7 mΩ max.
After environmental tests/ 10 mΩ max.
- Insulation resistance: 1,000 MΩ min.
- Withstanding voltage: 2,000 VAC/minute
- Applicable wire: AWG #22 to #12
- Applicable PC board thickness: 1.6 mm

* In using the products, refer to "Handling Precaution for Terminal and Connector" described on our website (Technical documents of Product information page).

* Contact JST for details.

* RoHS2 compliance

Note: The current rating differs depending on the number of circuits and the wire size used in each connector. The table below lists the current rating as a function of the number of circuits and the wire size.

No. of circuits	Wire size (AWG)					
	#12	#14	#16	#18	#20	#22
2	20	15	10	8	6	4
3	17	14	9	8	6	4
4	16	13	9	7	6	4
6	15	12	8	7	5	3
8	14	11	7	6	5	3
12	13	10	7	6	4	3

Current unit: A

Note: Do not branch in parallel current which exceeds the rated current (e.g. more than 17A in the case of 3 circuits with AWG #12). If branched in parallel, current imbalance or other problems may develop. If it is absolutely necessary to branch such a large current in parallel, design the circuits without causing any imbalance and provide an extra margin for each circuit.

Standards

Recognized E60389

Certified LR20812

R9351103

PC board layout and Assembly layout

<2, 3, 4 (Single-row) circuits>

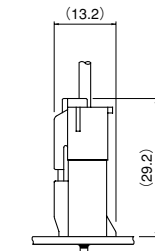
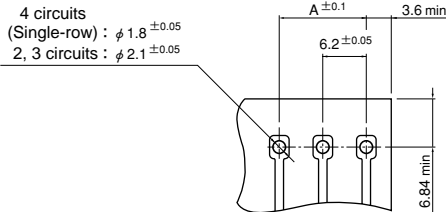

Inner-housing lock

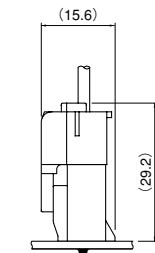

Outer-housing lock

<4, 6, 8, 12 circuits>

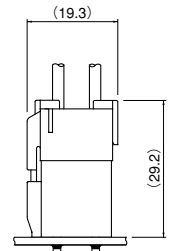
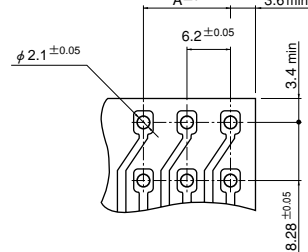

Inner-housing lock

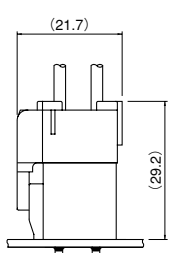

Outer-housing lock

Note: 1. The above figure is the figure viewed from soldering side.

2. Tolerances are non-cumulative: ± 0.05 mm for all centers.

3. Hole dimensions differ according to the type of PC board and piercing method. The dimensions above should serve as a guideline. Contact JST for details.

VL CONNECTOR

Contact

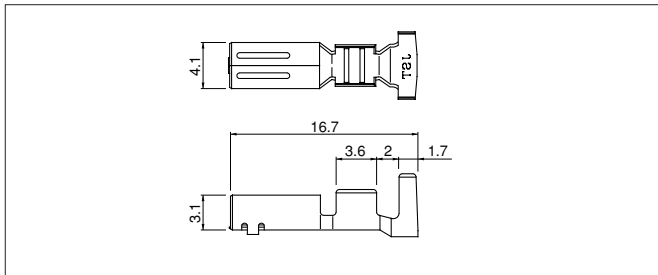

Model No.	Applicable wire		Insulation O.D. (mm)	Q'ty/reel
	mm ²	AWG #		
SVF-42T-P2.0	0.3~1.25	22~16	1.7~3.2	2,000
SVF-61T-P2.0	0.5~2.0	20~14	1.9~3.4	2,000
SVF-81T-P2.0	3.5	12	4.1	2,000

Material and Finish

Phosphor bronze, tin-plated (reflow treatment)

RoHS2 compliance

Contact	Crimping machine	Applicator		
		Crimp applicator	Dies	Crimp applicator with dies
SVF-42T-P2.0	AP-K2N	MKS-L	MK/SVF/M-42-20	APLMK SVF/M42-20
		—	—	—
SVF-61T-P2.0	—	MKS-L	MK/SVF/M-61-20	APLMK SVF/M61-20
		—	—	—

Note: Contact JST for fully automatic crimping applicator.

Housing (Inner-housing lock)

<2 circuits>

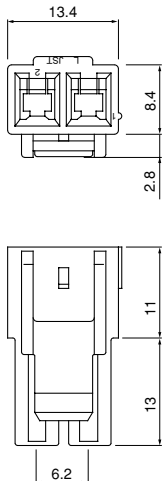

<3 circuits>

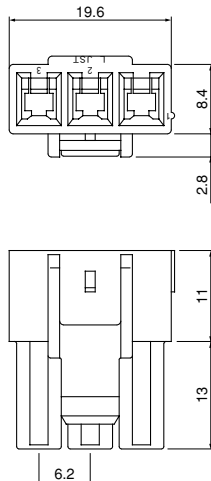

<4 circuits>

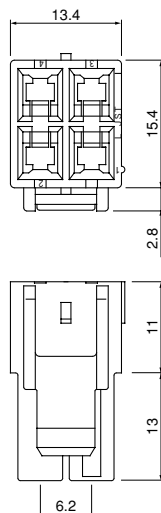

<6 circuits>

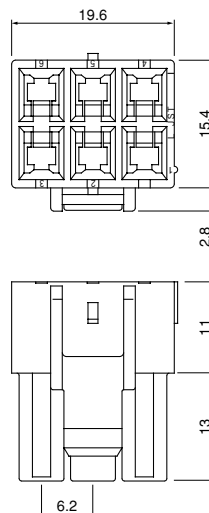

<8 circuits>

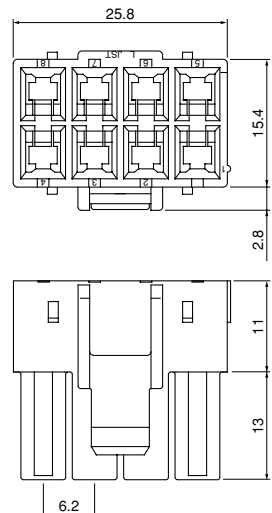

<12 circuits>

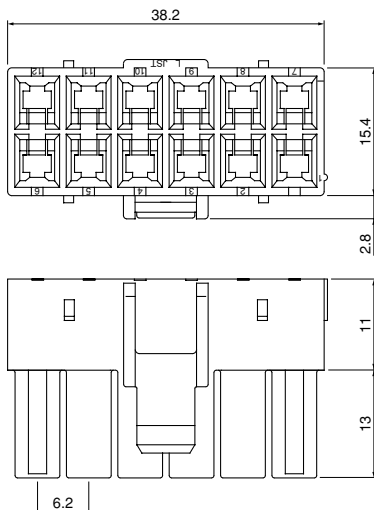

No. of circuits	Model No.	Q'ty/bag
2	VLP-02V	500
3	VLP-03V	500
4	VLP-04V	500
6	VLP-06V	500
8	VLP-08V	200
12	VLP-12V	100

Material

PA 66, UL94V-0, natural (white)

RoHS2 compliance

Note: Contact JST for Glow Wire compliant connectors.

VL CONNECTOR

Housing (Outer-housing lock)



No. of circuits	Model No.	Q'ty/bag
2	VLP-02V-1	500
3	VLP-03V-1	500
4	VLP-04V-1	500
4 (Single-row)	VLP-04VN-1	500
6	VLP-06V-1	500
8	VLP-08V-1	500
12	VLP-12V-1	500

Material

PA 66, UL94V-0, natural (white)

RoHS 2compliance

Note: Contact JST for Glow Wire compliant connectors.

VL CONNECTOR

Retainer

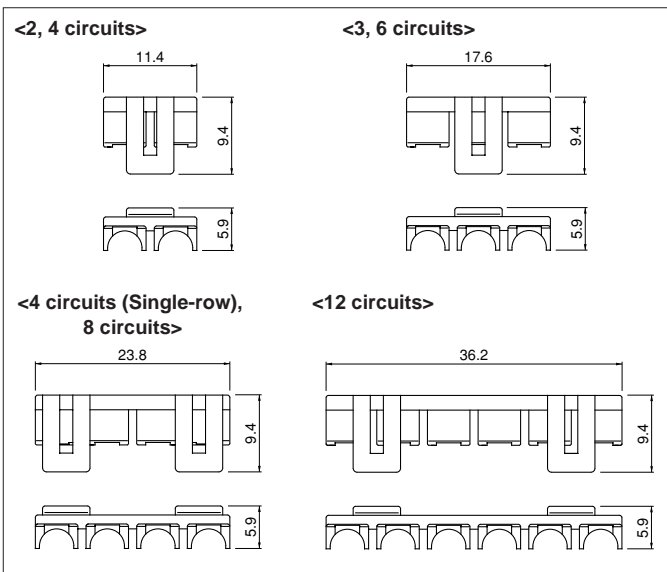

No. of circuits	Model No.	Q'ty/bag
2, 4	VLS-02V	1,000
3, 6	VLS-03V	1,000
4 (Single-row), 8	VLS-08V	1,000
12	VLS-12V	1,000

Material

Glass-filled PA 66, UL94V-0, natural (ivory)

RoHS2 compliance

Header

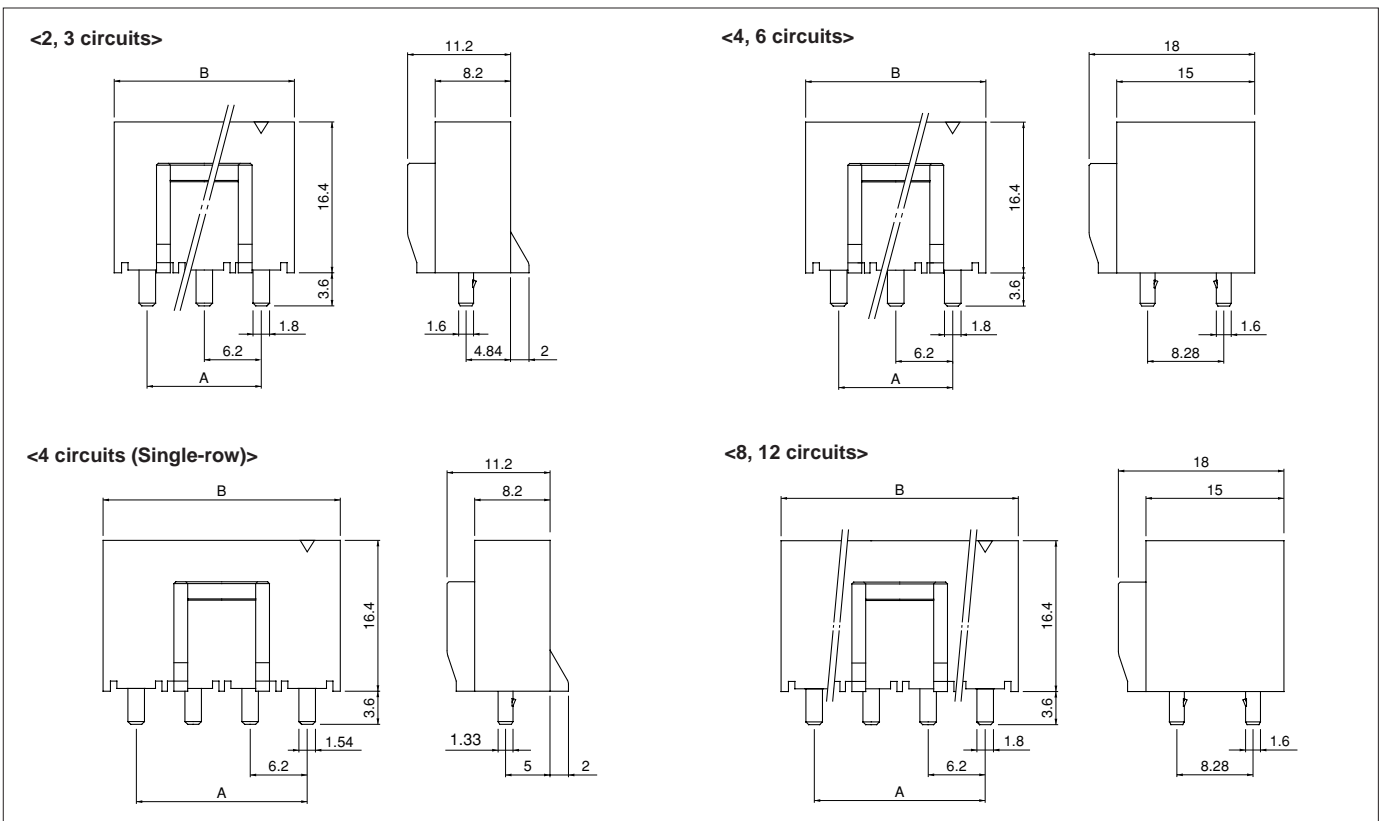

No. of circuits	Model No.	Dimensions (mm)		Q'ty/box
		A	B	
2	B02P-VL	6.2	13.4	100
3	B03P-VL	12.4	19.6	100
4	B04P-VL	6.2	13.4	100
4 (Single-row)	B04P-VL-VN-1.8	18.6	26.2	100
6	B06P-VL	12.4	19.6	50
8	B08P-VL	18.6	26.2	50
12	B12P-VL	31.0	38.6	35

Material and Finish

Post: Copper-alloy, tin-plated (reflow treatment)

Wafer: PA 66, UL94V-0, natural (white)

RoHS 2 compliance

Note: Contact JST for Glow Wire compliant connectors.

VL CONNECTOR

Contact position location numbers

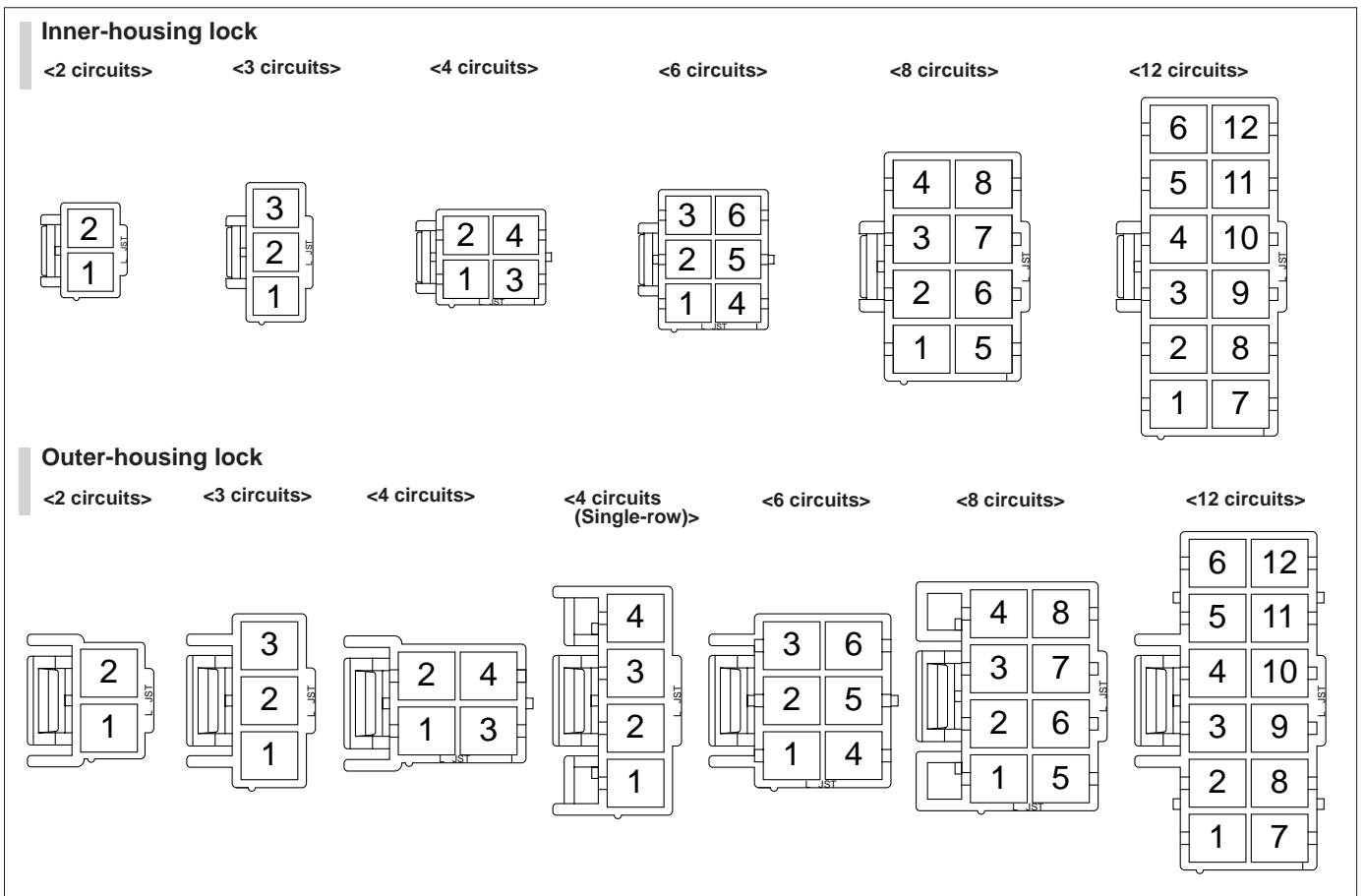

Model number identification

Connector

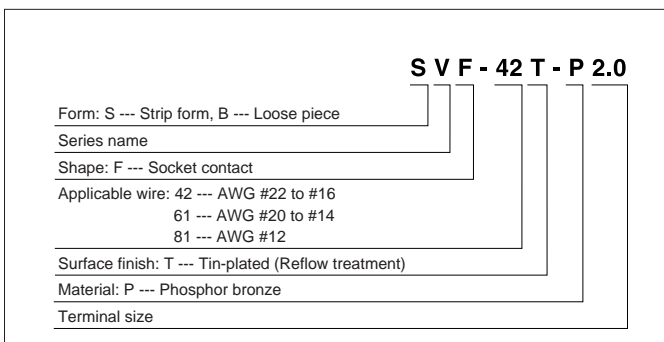

Housing

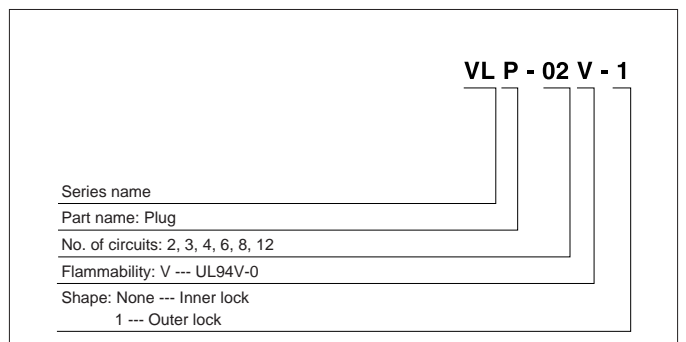

Header

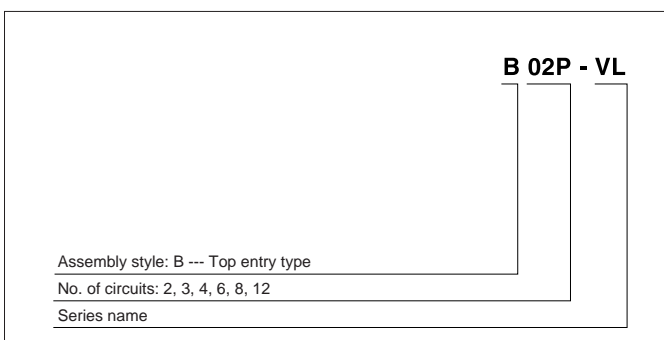

Retainer

