

MULTILAYER CHIP INDUCTORS FOR HIGH FREQUENCY APPLICATIONS HK 2125 TYPE

HK 2125 R39J-T

- [Notes]
- This document is for reference use only and does not guarantee the specifications of the products.
 - The contents of this document are based on the existing April 1, 2020.
 - This document is subject to change for improvements or others without notice.
 - Please request and agree to the specification document of the products before purchasing and using them regardless of types of applications.
 - Please check and comply with the usage conditions and precautions described in this specification. Before use, please be sure to verify and validate the products under intended operating environmental conditions with the products being installed in actual devices.

1. Scope

This specification covers multilayer chip inductors for high frequency applications (HK 2125 type) for use in electronic appliances and electric communication equipment. For the details of such equipment, please refer to "Section 6-1 Basic Information" in this specification.

2. Part Numbering System

Part number is indicated as follows:

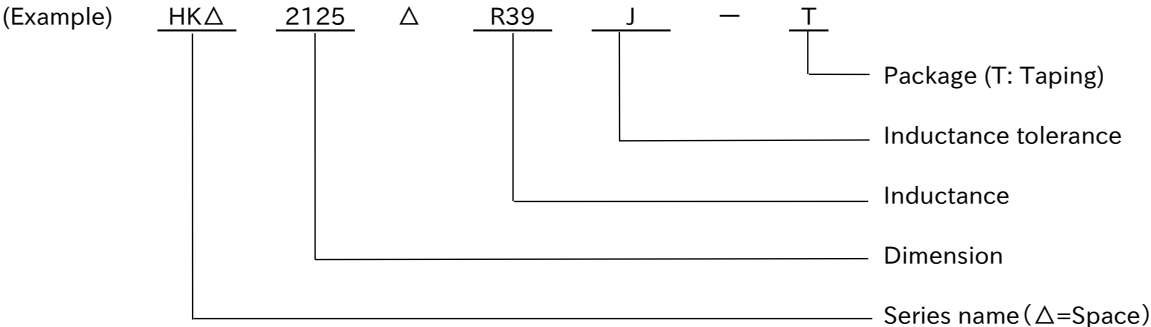

3. Shape, Structure, and Dimension

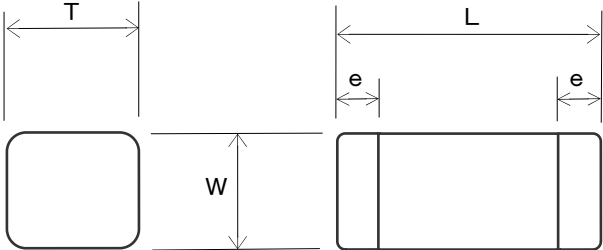

Type	Dimension [mm]			
	L	W	T	e
2125	2.0 +0.3/-0.1	1.25±0.2	1.0 +0.2/-0.3	0.5±0.3

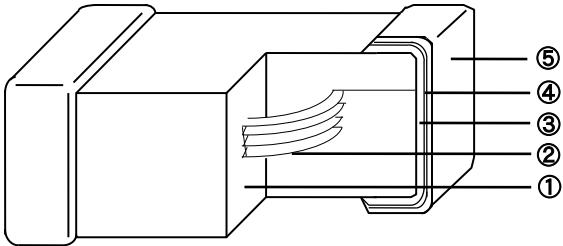

	Name	Material
①	Chip body	Dielectric ceramic
②	Internal Conductors	Ag
③	Terminal Electrodes (Base)	Ag
④	Terminal Electrodes (Plating)	Ni
⑤	Terminal Electrodes (Surface)	Sn

4. Rated Value

Operating Temperature Range: -40°C to +85°C

Part number	Nominal inductance	Inductance tolerance	Q (min.)	Measuring frequency	Self-resonant frequency (min.)	DC resistance (max.)	Rated current (max.)
HK 2125 R39J-T	0.39 uH	± 5 %	10	50 MHz	250 MHz	1.3 Ω	300 mA

5. Functions and Test Methods

•Test Conditions:

Standard test conditions shall be temperature of 5°C to 35°C, relative humidity of 25% to 85%. Tests shall be conducted at temperature of 20°C±2°C, relative humidity of 60% to 70% and air pressure of 86kPa to 106kPa if test results are suspicious. Unless otherwise specified, all tests shall be conducted under the standard test conditions.

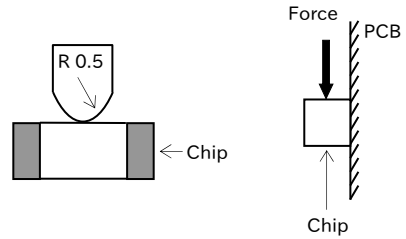
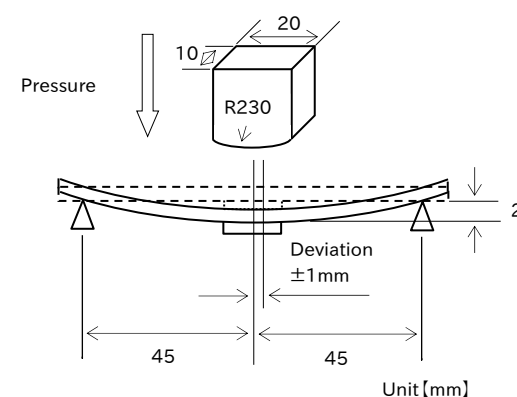
No.	Item	Specified Value	Testing Method
5.1	Inductance	Per Section 4	Inductance/Q shall be measured at 100±1MHz. Measuring equipment: 4291A (or equivalent equipment) Measuring jig: 16092A (or equivalent equipment)
5.2	Q		
5.3	Self-resonant frequency	Per Section 4	Measuring equipment: 8719C (or equivalent equipment)
5.4	DC Resistance	Per Section 4	DC resistance across electrodes shall be measured. Measuring equipment: VOAC-7512 (or equivalent equipment)
5.5	Definition of Rated Current	Inductance decrease within 5% and temperature rise in an element within 20°C	The rated current shall be applied to test samples.
5.6	Adhesion of Terminal Electrode	No exfoliation	<p>Test samples shall be soldered to test boards. A force of 10N shall be applied in vertically downward direction with a R 0.5 fixture for 10 seconds.</p> 
5.7	Bending Strength	No mechanical damage	<p>Test samples shall be soldered to test boards. A force shall be applied in a downward direction until amount of deflection reaches 2mm. Test board dimension: 100×40×0.8mm Test board material: Glass epoxy</p> 

No.	Item	Specified Value	Testing Method										
5.8	Vibration	<table border="1"> <tr> <td>Appearance</td> <td>No remarkable defect</td> </tr> <tr> <td>Inductance change rate</td> <td>Within $\pm 10\%$</td> </tr> <tr> <td>Q change rate</td> <td>Within $\pm 20\%$</td> </tr> </table>	Appearance	No remarkable defect	Inductance change rate	Within $\pm 10\%$	Q change rate	Within $\pm 20\%$	<p>Test samples shall be vibrated under the following conditions:</p> <ul style="list-style-type: none"> - Frequency range: 10Hz to 55Hz - Overall amplitude: 1.5mm - Sweeping method: 10Hz - 55Hz - 10Hz for 1 minute - 2 hours each in X, Y, Z directions: 6 hours in total 				
Appearance	No remarkable defect												
Inductance change rate	Within $\pm 10\%$												
Q change rate	Within $\pm 20\%$												
5.9	Solderability	<p>More than 90% of terminal electrode shall be covered with fresh solder.</p>	<p><Preconditioning> Test samples shall be immersed into flux.</p> <p><Test> Test samples shall be immersed into molten solder under the conditions shown in the tables below, then taken out and checked visually. The speed of immersion and taking out shall be 25mm/s.</p> <p>(Eutectic solder)</p> <table border="1"> <tr> <td>Solder temperature</td> <td>230°C\pm5°C</td> </tr> <tr> <td>Immersion time</td> <td>4s\pm1s</td> </tr> </table> <p>(Pb-free solder Sn/3.0Ag/0.5Cu)</p> <table border="1"> <tr> <td>Solder temperature</td> <td>245°C\pm3°C</td> </tr> <tr> <td>Immersion time</td> <td>4s\pm1s</td> </tr> </table>	Solder temperature	230°C \pm 5°C	Immersion time	4s \pm 1s	Solder temperature	245°C \pm 3°C	Immersion time	4s \pm 1s		
Solder temperature	230°C \pm 5°C												
Immersion time	4s \pm 1s												
Solder temperature	245°C \pm 3°C												
Immersion time	4s \pm 1s												
5.10	Resistance to Soldering Heat	<table border="1"> <tr> <td>Appearance</td> <td>No remarkable defect</td> </tr> <tr> <td>Inductance change rate</td> <td>Within $\pm 5\%$</td> </tr> </table>	Appearance	No remarkable defect	Inductance change rate	Within $\pm 5\%$	<p><Preconditioning> Test samples shall be immersed into flux. Preheating as shown in the table below shall be conducted.</p> <p><Test> Test samples shall be immersed into molten solder under the conditions shown in the table below and taken out. The speed of immersion and taking out shall be 25mm/s. Test samples shall be kept at ambient temperature for 2 or 3 hours (Note 1) before measurement.</p> <table border="1"> <tr> <td>Preheating</td> <td>150°C, 3min.</td> </tr> <tr> <td>Resistance to Soldering Heat</td> <td>260°C\pm5°C</td> </tr> <tr> <td>Immersion time</td> <td>10s\pm0.5s</td> </tr> </table>	Preheating	150°C, 3min.	Resistance to Soldering Heat	260°C \pm 5°C	Immersion time	10s \pm 0.5s
Appearance	No remarkable defect												
Inductance change rate	Within $\pm 5\%$												
Preheating	150°C, 3min.												
Resistance to Soldering Heat	260°C \pm 5°C												
Immersion time	10s \pm 0.5s												

(Note 1) If any doubt arises in the result of measurement, another measurement shall be conducted after leaving test samples to stand for 48 \pm 2 hours.

No.	Item	Specified Value	Testing Method																					
5.11	Thermal Shock	<table border="1"> <tr> <td>Appearance</td> <td>No remarkable defect</td> </tr> <tr> <td>Inductance change rate</td> <td>Within $\pm 10\%$</td> </tr> <tr> <td>Q change rate</td> <td>Within $\pm 20\%$</td> </tr> </table>	Appearance	No remarkable defect	Inductance change rate	Within $\pm 10\%$	Q change rate	Within $\pm 20\%$	<p>Test samples shall be exposed to steps 1 to 4 shown in the table below as one cycle. The test should be repeated for 5 times.</p> <p>Test samples shall be kept at normal temperature and normal humidity for 2 to 3 hours before measurement. (Note 1)</p> <table border="1"> <thead> <tr> <th>Step</th> <th>Temperature</th> <th>Time</th> </tr> </thead> <tbody> <tr> <td>1</td> <td>$-40^{\circ}\text{C} \begin{smallmatrix} +0 \\ -3 \end{smallmatrix} \text{ }^{\circ}\text{C}$</td> <td>30min.$\pm$3min.</td> </tr> <tr> <td>2</td> <td>Normal temp.</td> <td>2min. to 3min.</td> </tr> <tr> <td>3</td> <td>$+85^{\circ}\text{C} \begin{smallmatrix} +3 \\ -0 \end{smallmatrix} \text{ }^{\circ}\text{C}$</td> <td>30min.$\pm$3min.</td> </tr> <tr> <td>4</td> <td>Normal temp.</td> <td>2min. to 3min.</td> </tr> </tbody> </table>	Step	Temperature	Time	1	$-40^{\circ}\text{C} \begin{smallmatrix} +0 \\ -3 \end{smallmatrix} \text{ }^{\circ}\text{C}$	30min. \pm 3min.	2	Normal temp.	2min. to 3min.	3	$+85^{\circ}\text{C} \begin{smallmatrix} +3 \\ -0 \end{smallmatrix} \text{ }^{\circ}\text{C}$	30min. \pm 3min.	4	Normal temp.	2min. to 3min.
Appearance	No remarkable defect																							
Inductance change rate	Within $\pm 10\%$																							
Q change rate	Within $\pm 20\%$																							
Step	Temperature	Time																						
1	$-40^{\circ}\text{C} \begin{smallmatrix} +0 \\ -3 \end{smallmatrix} \text{ }^{\circ}\text{C}$	30min. \pm 3min.																						
2	Normal temp.	2min. to 3min.																						
3	$+85^{\circ}\text{C} \begin{smallmatrix} +3 \\ -0 \end{smallmatrix} \text{ }^{\circ}\text{C}$	30min. \pm 3min.																						
4	Normal temp.	2min. to 3min.																						
5.12	Resistance to Humidity	<table border="1"> <tr> <td>Appearance</td> <td>No remarkable defect</td> </tr> <tr> <td>Inductance change rate</td> <td>Within $\pm 10\%$</td> </tr> <tr> <td>Q change rate</td> <td>Within $\pm 20\%$</td> </tr> </table>	Appearance	No remarkable defect	Inductance change rate	Within $\pm 10\%$	Q change rate	Within $\pm 20\%$	<p>Test samples shall be kept in an atmosphere at temperature and humidity of $60^{\circ}\text{C} \pm 2^{\circ}\text{C}$ and 90% to 95%RH for 500 +24/-0 hours.</p> <p>Test samples shall be kept at normal temperature and normal humidity for 2 to 3 hours before measurement. (Note 1)</p>															
Appearance	No remarkable defect																							
Inductance change rate	Within $\pm 10\%$																							
Q change rate	Within $\pm 20\%$																							
5.13	High Temperature Load Life Test	<table border="1"> <tr> <td>Appearance</td> <td>No remarkable defect</td> </tr> <tr> <td>Inductance change rate</td> <td>Within $\pm 10\%$</td> </tr> <tr> <td>Q change rate</td> <td>Within $\pm 20\%$</td> </tr> </table>	Appearance	No remarkable defect	Inductance change rate	Within $\pm 10\%$	Q change rate	Within $\pm 20\%$	<p>Test samples shall be kept in an atmosphere at temperature of $85^{\circ}\text{C} \pm 2^{\circ}\text{C}$ for 500 +24/-0 hours while the rated current is continuously applied.</p> <p>Test samples shall be kept at normal temperature and normal humidity for 2 to 3 hours before measurement. (Note 1)</p>															
Appearance	No remarkable defect																							
Inductance change rate	Within $\pm 10\%$																							
Q change rate	Within $\pm 20\%$																							
5.14	Humidity Resistance Load Life Test	<table border="1"> <tr> <td>Appearance</td> <td>No remarkable defect</td> </tr> <tr> <td>Inductance change rate</td> <td>Within $\pm 10\%$</td> </tr> <tr> <td>Q change rate</td> <td>Within $\pm 20\%$</td> </tr> </table>	Appearance	No remarkable defect	Inductance change rate	Within $\pm 10\%$	Q change rate	Within $\pm 20\%$	<p>Test samples shall be kept in an atmosphere at temperature and humidity of $60^{\circ}\text{C} \pm 2^{\circ}\text{C}$ and 90% to 95%RH for 500 +24/-0 hours while the rated current is continuously applied.</p> <p>Test samples shall be kept at normal temperature and normal humidity for 2 to 3 hours before measurement. (Note 1)</p>															
Appearance	No remarkable defect																							
Inductance change rate	Within $\pm 10\%$																							
Q change rate	Within $\pm 20\%$																							

(Note 1) If any doubt arises in the result of measurement, another measurement shall be conducted after leaving test samples to stand for 48 ± 2 hours.

6. Basic Information and Others

6-1 Basic Information

6-1-1. Equipment Intended for Use

The products listed in this specification are intended for general-purpose and standard use in general electronic equipment (e.g., AV equipment, OA equipment, home electric appliances, office equipment, information and communication equipment including, without limitation, mobile phone, and PC) and other equipment specified in this specification.

TAIYO YUDEN has the line-up of the products intended for use in automotive electronic equipment, telecommunications infrastructure and industrial equipment, or medical devices classified as GHTF Classes A to C (Japan Classes I to III). Therefore, when using our products for this equipment, please check available applications specified in the catalog or the individual product specification sheets and use the corresponding products.

6-1-2. Equipment Requiring Inquiry

Please be sure to contact TAIYO YUDEN for further information before using the products listed in this specification for the following equipment (excluding intended equipment as specified in the catalog or this specification) which may cause loss of human life, bodily injury, serious property damage and/or serious public impact due to a failure or defect of the products and/or malfunction attributed thereto.

- (1) Transportation equipment (automotive powertrain control system, train control system, and ship control system, etc.)
- (2) Traffic signal equipment
- (3) Disaster prevention equipment, crime prevention equipment
- (4) Medical devices classified as GHTF Class C (Japan Class III)
- (5) Highly public information network equipment, data-processing equipment (telephone exchange, and base station, etc.)
- (6) Any other equipment requiring high levels of quality and/or reliability equal to the equipment listed above

6-1-3. Equipment Prohibited for Use

Please do not incorporate our products into the following equipment requiring extremely high levels of safety and/or reliability.

- (1) Aerospace equipment (artificial satellite, rocket, etc.)
- (2) Aviation equipment *1
- (3) Medical devices classified as GHTF Class D (Japan Class IV), implantable medical devices *2
- (4) Power generation control equipment (nuclear power, hydroelectric power, thermal power plant control system, etc.)
- (5) Undersea equipment (submarine repeating equipment, underwater work equipment, etc.)
- (6) Military equipment
- (7) Any other equipment requiring extremely high levels of safety and/or reliability equal to the equipment listed above

*Notes:

1. There is a possibility that our products can be used only for aviation equipment that does not directly affect the safe operation of aircraft (e.g., in-flight entertainment, cabin light, electric seat, cooking equipment) if such use meets requirements specified separately by TAIYO YUDEN. Please be sure to contact TAIYO YUDEN for further information before using our products for such aviation equipment.
2. Implantable medical devices contain not only internal unit which is implanted in a body, but also external unit which is connected to the internal unit.

6-1-4. Limitation of Liability

Please note that unless you obtain prior written consent of TAIYO YUDEN, TAIYO YUDEN shall not be in any way responsible for any damages incurred by you or third parties arising from use of the products listed in this specification for any equipment that is not intended for use by TAIYO YUDEN, or any equipment requiring inquiry to TAIYO YUDEN or prohibited for use by TAIYO YUDEN as described above.

6-2 RoHS Compliance

- The products conform to RoHS.

“RoHS compliance” means that the products do not contain lead, cadmium, mercury, hexavalent chromium, PBB, PBDE, DEHP, BBP, DBP, or DIBP referring to EU Directive 2011/65/EU, except other non-restricted substances or impurities which cannot be technically removed at refining process.

- The products are halogen-free.

7. Packaging

7-1 External Dimension of Tape (Embossed tape)

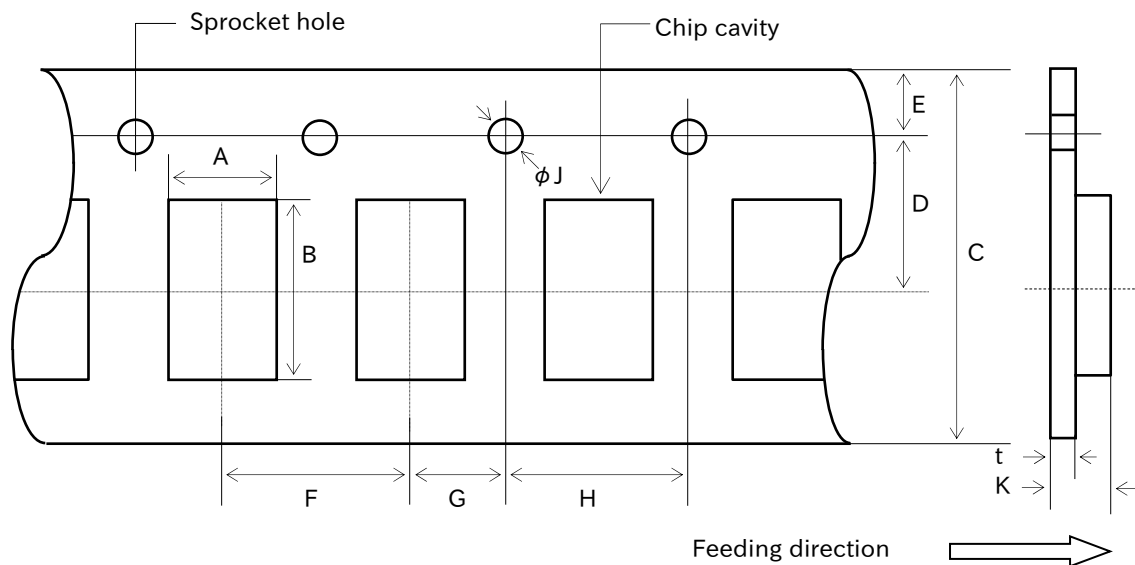

Product thickness:0.85mm

Code	A※	B※	C	D	E	F	G	H	ϕJ	K※	t
Dimension	1.5±0.2	2.3±0.2	8.0±0.3	3.5±0.05	1.75±0.1	4.0±0.1	2.0±0.05	4.0±0.1	1.5 ^{+0.1} ₋₀	1.5 max.	0.3 max.

Product thickness:1.0mm

Code	A※	B※	C	D	E	F	G	H	ϕJ	K※	t
Dimension	1.5±0.2	2.3±0.2	8.0±0.3	3.5±0.05	1.75±0.1	4.0±0.1	2.0±0.05	4.0±0.1	1.5 ^{+0.1} ₋₀	2.0 max.	0.3 max.

※A, B, K: Sufficient clearance

Unit [mm]

7-2 Labels and Dimensions of Reel

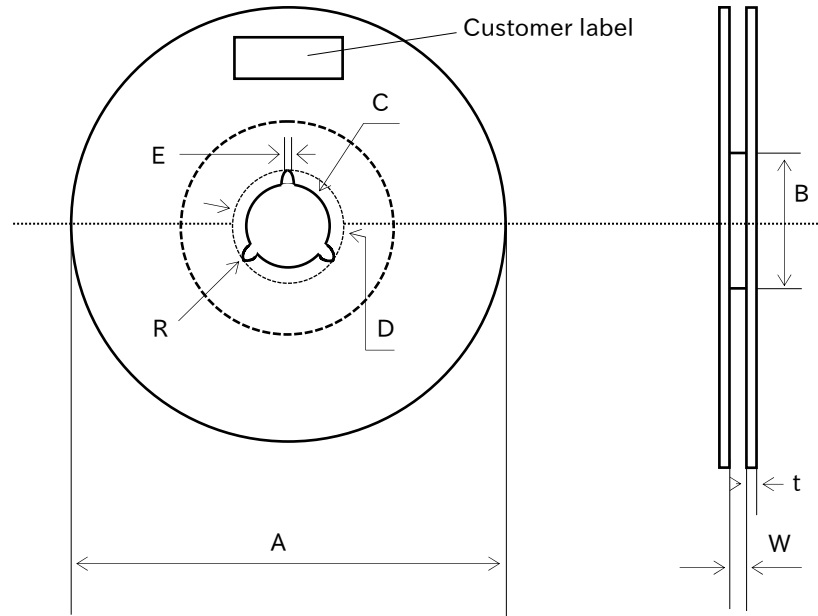

Customer label description

1. Manufacturer name
2. Customer part No.
3. Our part No.
4. Quantity
5. Control No. (Shipping lot No.)
6. Manufacturing site (MADE IN ○○○)
7. RoHS

Code	ϕA	ϕB	ϕC	ϕD	E	W	t	R
Dimension	178 ± 2.0	50 min.	13 ± 0.2	21 ± 0.8	2.0 ± 0.5	10 ± 1.5	2.5 max.	1.0

Unit [mm]

7-3 Packaging Form

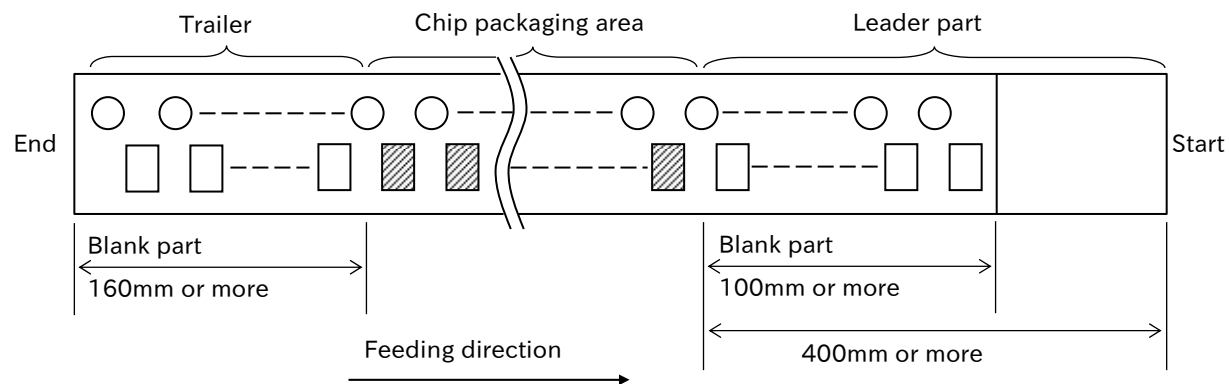

The number of empty compartments in a reel, which shall not appear continuously, must be limited to 2.

7-4 Tensile Strength of Tape

Tensile strength of the tape shall be 5N or over.

7-5 Top Tape Strength

Peeling strength of the top tape shall be 0.1N to 0.7N when the top tape is peeled from carrier tape at an angle as the figure below shows.

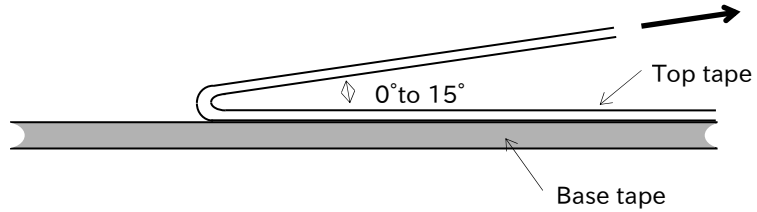

7-6 Quantity of Taping Package

TYPE	Thickness T	1 reel	1 carton box
2125	0.85 mm	4,000/reel	20,000/5 reels
	1.0 mm	3,000/reel	15,000/5 reels

7-7 Labels and Dimensions of Reel Box

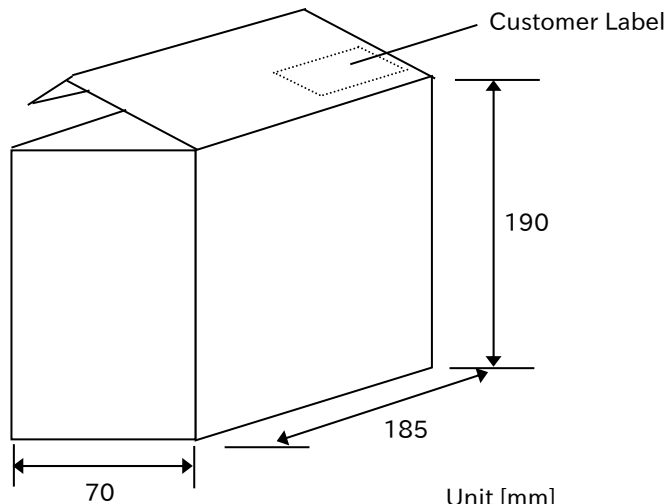

Unit [mm]
(The size is only for reference.)

Customer label description

1. Manufacturer name
2. Customer part No.
3. Our part No.
4. Quantity
5. Control No. (Shipping lot No.)
6. Manufacturing site (MADE IN ○○○)
7. RoHS

■ PRECAUTIONS

1. Circuit Design

Precautions	<ul style="list-style-type: none">◆ Verification of operating environment, electrical rating and performance<ol style="list-style-type: none">1. A malfunction in medical equipment, spacecraft, nuclear reactors, etc. may cause serious harm to human life or have severe social ramifications. As such, any inductors to be used in such equipment may require higher safety and/or reliability considerations and should be clearly differentiated from components used in general purpose applications.2. When inductors are used in places where dew condensation develops and/or where corrosive gas such as hydrogen sulfide, sulfurous acid, or chlorine exists in the air, characteristic deterioration may occur. Please do not use inductors under such environmental conditions.◆ Operating Current (Verification of Rated current)<ol style="list-style-type: none">1. The operating current including inrush current for inductors must always be lower than their rated values.2. Do not apply current in excess of the rated value because the inductance may be reduced due to the magnetic saturation effect.
-------------	---

2. PCB Design

Precautions	<ul style="list-style-type: none">◆ Pattern configurations (Design of Land-patterns)<ol style="list-style-type: none">1. When inductors are mounted on a PCB, the size of land patterns and the amount of solder used (size of fillet) can directly affect inductor performance. Therefore, the following items must be carefully considered in the design of solder land patterns:<ol style="list-style-type: none">(1) The amount of solder applied can affect the ability of chips to withstand mechanical stresses which may lead to breaking or cracking. Therefore, when designing land-patterns it is necessary to consider the appropriate size and configuration of the solder pads which in turn determines the amount of solder necessary to form the fillets.(2) When more than one part is jointly soldered onto the same land or pad, the pad must be designed so that each component's soldering point is separated by solder-resist.(3) The larger size of land patterns and amount of solder, the smaller Q value after mounting on PCB. It makes higher the Q value to design land patterns smaller than terminal electrode of chips.◆ Pattern configurations (Inductor layout on panelized [breakaway] PC boards)<ol style="list-style-type: none">1. After inductors have been mounted on the boards, chips can be subjected to mechanical stresses in subsequent manufacturing processes (PCB cutting, board inspection, mounting of additional parts, assembly into the chassis, wave soldering the reflow soldered boards etc.) For this reason, planning pattern configurations and the position of SMD inductors should be carefully performed to minimize stress.
-------------	--

◆ Pattern configurations (Design of Land-patterns)

1. The following diagrams and tables show some examples of recommended patterns to prevent excessive solder amounts (larger fillets which extend above the component end terminations). Examples of improper pattern designs are also shown.

(1) Recommended land dimensions for a typical chip inductor land patterns for PCBs

● Recommended land dimensions for Multilayer inductor

Wave-soldering (Unit:mm)

Type	1608	2012	2125	2016	2520	3216
Size	L	1.6	2.0	2.0	2.5	3.2
	W	0.8	1.25	1.25	1.6	2.0
A	0.8~1.0	1.0~1.4	1.0~1.4	1.0~1.4	1.0~1.4	1.8~2.5
B	0.5~0.8	0.8~1.5	0.8~1.5	0.8~1.5	0.6~1.0	0.8~1.7
C	0.6~0.8	0.9~1.2	0.9~1.2	1.3~1.6	1.6~2.0	1.2~1.6

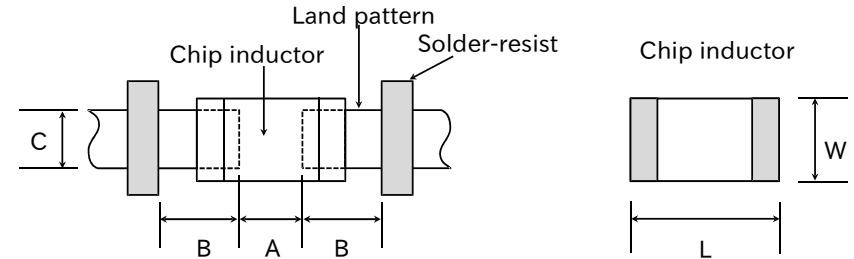

Reflow-soldering (Unit:mm)

Type	0603	1005	105	1608	2012	2125	2016	2520	3216
Size	L	0.6	1.0	1.0	1.6	2.0	2.0	2.5	3.2
	W	0.3	0.5	0.6	0.8	1.25	1.25	1.6	1.6
A	0.20~0.30	0.45~0.55	0.50~0.55	0.8~1.0	0.8~1.2	0.8~1.2	0.8~1.2	1.0~1.4	1.8~2.5
B	0.20~0.30	0.40~0.50	0.30~0.40	0.6~0.8	0.8~1.2	0.8~1.2	0.8~1.2	0.6~1.0	0.6~1.5
C	0.25~0.40	0.45~0.55	0.60~0.70	0.6~0.8	0.9~1.6	0.9~1.6	1.2~2.0	1.8~2.2	1.2~2.0

● Recommended land dimension for Array type

(Unit:mm)

Type	2010	3216	
Size	L	2.0	3.2
	W	1.0	1.6
a	0.5~0.6	0.7~0.9	
b	0.5~0.6	0.8~1.0	
c	0.2~0.3	0.4~0.5	
d	0.5	0.8	

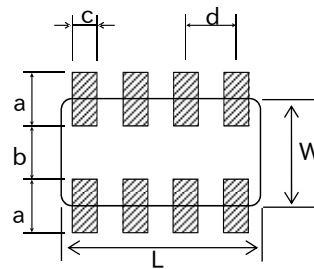

● Recommended land dimension for Multilayer common mode choke coil

(Unit:mm)

Type	0605	0806	
Size	L	0.65	0.85
	W	0.50	0.65
a	0.27~0.30	0.25~0.35	
b	0.17~0.20	0.25~0.35	
c	0.20~0.26	0.25~0.35	
d	0.4	0.5	

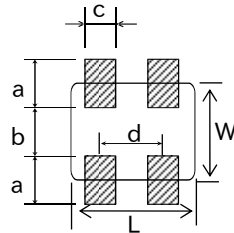

(Unit:mm)

Type	1210	
Size	L	1.0
	W	1.25
a	0.45~0.55	
b	0.7~0.8	
c	0.25~0.35	
d	0.55	

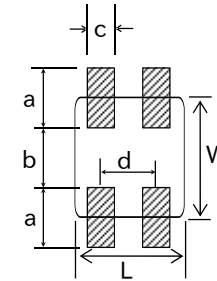

(2) Examples of good and bad solder application

Item	Not recommended	Recommended
Mixed mounting of SMD and leaded components	<p>Lead wire of component</p>	<p>Solder-resist</p>
Component placement close to the chassis	<p>Chassis Solder (for grounding) Electrode pattern</p>	<p>Solder-resist</p>
Hand-soldering of leaded components near mounted components	<p>Lead wire of component Soldering iron</p>	<p>Solder-resist</p>
Horizontal component placement		<p>Solder-resist</p>

◆Pattern configurations (Inductor layout on panelized [breakaway] PC boards)

1-1. The following are examples of good and bad inductor layout; SMD inductors should be located to minimize any possible mechanical stresses from board warp or deflection.

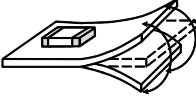
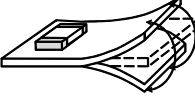
Item	Not recommended	Recommended
Deflection of the board		 <p data-bbox="1288 223 1630 351">Position the component at a right angle to the direction of the mechanical stresses that are anticipated</p>

1-2. To layout the inductors for the breakaway PC board, it should be noted that the amount of mechanical stresses given will vary depending on inductor layout. An example below should be counted for better design.

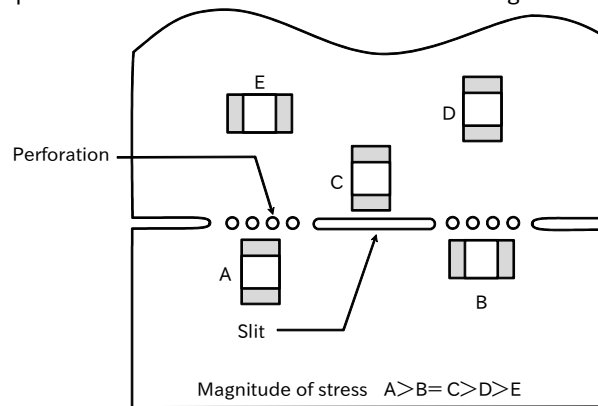

1-3. When breaking PC boards along their perforations, the amount of mechanical stress on the inductors can vary according to the method used. The following methods are listed in order from least stressful to most stressful: push-back, slit, V-grooving, and perforation. Thus, any ideal SMD inductor layout must also consider the PCB splitting procedure.

3. Considerations for automatic placement

Precautions

◆Adjustment of mounting machine

1. Excessive impact load should not be imposed on the inductors when mounting onto the PC boards.
2. The maintenance and inspection of the moulder should be conducted periodically.

◆Selection of Adhesives

1. Mounting inductors with adhesives in preliminary assembly, before the soldering stage, may lead to degraded inductor characteristics unless the following factors are appropriately checked; the size of land patterns, type of adhesive, amount applied, hardening temperature and hardening period. Therefore, it is imperative to consult the manufacturer of the adhesives on proper usage and amounts of adhesive to use.

Technical considerations

◆Adjustment of mounting machine

1. If the lower limit of the pick-up nozzle is low, too much force may be imposed on the inductors, causing damage. To avoid this, the following points should be considered before lowering the pick-up nozzle:
 - (1) The lower limit of the pick-up nozzle should be adjusted to the surface level of the PC board after correcting for deflection of the board.
 - (2) The pick-up pressure should be adjusted between 1 and 3N static loads.
 - (3) To reduce the amount of deflection of the board caused by impact of the pick-up nozzle, supporting pins or back-up pins should be used under the PC board.

The following diagrams show some typical examples of good pick-up nozzle placement

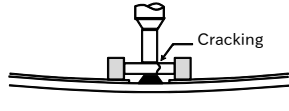
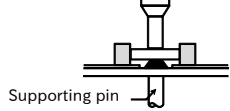
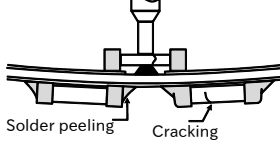
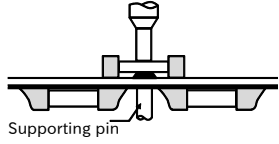
Item	Improper method	Proper method
Single-sided mounting	 Cracking	 Supporting pin
Double-sided mounting	 Solder peeling Cracking	 Supporting pin

2. As the alignment pin wears out, adjustment of the nozzle height can cause chipping or cracking of the inductors because of mechanical impact on the inductors. To avoid this, the monitoring of the width between the alignment pin in the stopped position, and maintenance, inspection and replacement of the pin should be conducted periodically

◆ Selection of Adhesives

1. Some adhesives may cause reduced insulation resistance. The difference between the shrinkage percentage of the adhesive and that of the inductors may result in stresses on the inductors and lead to cracking. Moreover, too little or too much adhesive applied to the board may adversely affect component placement, so the following precautions should be noted in the application of adhesives.

(1) Required adhesive characteristics

- a. The adhesive should be strong enough to hold parts on the board during the mounting & solder process.
- b. The adhesive should have sufficient strength at high temperatures.
- c. The adhesive should have good coating and thickness consistency.
- d. The adhesive should be used during its prescribed shelf life.
- e. The adhesive should harden rapidly.
- f. The adhesive must not be contaminated.
- g. The adhesive should have excellent insulation characteristics.
- h. The adhesive should not be toxic and have no emission of toxic gasses.

(2) When using adhesives to mount inductors on a PCB, inappropriate amounts of adhesive on the board may adversely affect component placement. Too little adhesive may cause the inductors to fall off the board during the solder process. Too much adhesive may cause defective soldering due excessive flow of adhesive on to the land or solder pad.

[Recommended conditions]

Figure	0805 case sizes as examples
a	0.3mm min
b	100~120 μ m
c	Area with no adhesive

Amount of adhesives

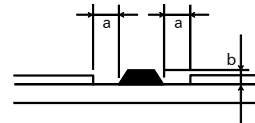

After inductors are bonded

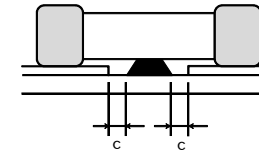

4. Soldering

Precautions

◆ Selection of Flux

- Since flux may have a significant effect on the performance of inductors, it is necessary to verify the following conditions prior to use;
 - Flux used should be with less than or equal to 0.1 wt% (Chlorine conversion method) of halogenated content. Flux having a strong acidity content should not be applied.
 - When soldering inductors on the board, the amount of flux applied should be controlled at the optimum level.
 - When using water-soluble flux, special care should be taken to properly clean the boards.

◆ Soldering

- Temperature, time, amount of solder, etc. are specified in accordance with the following recommended conditions, and please contact us about peak temperature when you use lead-free paste.

Technical considerations

◆ Selection of Flux

- 1-1. When too much halogenated substance (Chlorine, etc.) content is used to activate the flux, or highly acidic flux is used, an excessive amount of residue after soldering may lead to corrosion of the terminal electrodes or degradation of insulation resistance on the surface of the Inductor.
- 1-2. Flux is used to increase solderability in flow soldering, but if too much is applied, a large amount of flux gas may be emitted and may detrimentally affect solderability. To minimize the amount of flux applied, it is recommended to use a flux-bubbling system.
- 1-3. Since the residue of water-soluble flux is easily dissolved by water content in the air, the residue on the surface of Inductor in high humidity conditions may cause a degradation of insulation resistance and therefore affect the reliability of the components. The cleaning methods and the capability of the machines used should also be considered carefully when selecting water-soluble flux.

◆ Soldering

1-1. Preheating when soldering

Preheating: Inductors shall be preheated sufficiently, and the temperature difference between the inductors and solder shall be within 130°C.

Cooling: The temperature difference between the components and cleaning process should not be greater than 100°C.

Inductors are susceptible to thermal shock when exposed to rapid or concentrated heating or rapid cooling. Therefore, the soldering process must be conducted with a great care so as to prevent malfunction of the components due to excessive thermal shock.

[Reflow soldering]

[Recommended condition for Pb-free soldering]

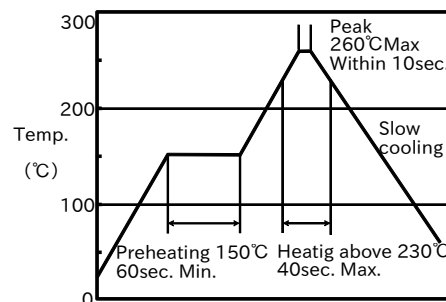

Caution

- Solder (fillet) should wet up to 1/2 to 1/3 of the thickness of an inductor ideally as shown below:
- Because excessive dwell time can detrimentally affect solderability, soldering duration shall be kept as close to recommended time as possible.
- The allowable number of reflow soldering is two (2) times.

[Wave soldering]

[Recommended condition for Pb-free soldering]

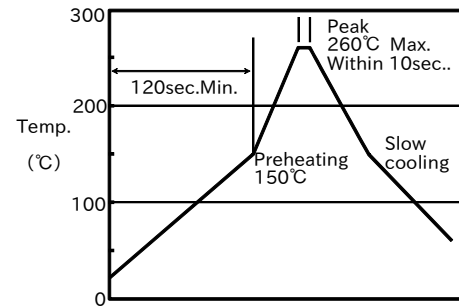

Caution

1. Make sure the inductors are preheated sufficiently.
2. The temperature difference between the inductor and melted solder should be within 130°C.
3. Cooling after soldering should be as gradual as possible.
4. The allowable number of wave soldering is one (1) time.
5. Wave soldering must not be applied to the inductors designated as for reflow soldering only

[Hand soldering]

[Recommended condition for Pb-free soldering]

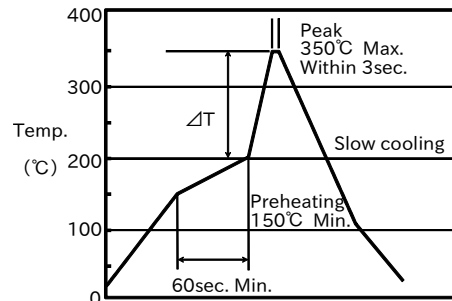

Caution

1. It is recommended to use a 20W soldering iron with a maximum tip diameter of 1.0 mm.
2. The soldering iron shall not directly touch inductors
3. The allowable number of hand soldering is one (1) time

※ $\Delta T \leq 150^\circ\text{C}$

5. Cleaning	
Precautions	<p>◆Cleaning conditions</p> <ol style="list-style-type: none"> 1. When cleaning the PC board after the Inductors are all mounted, select the appropriate cleaning solution according to the type of flux used and purpose of the cleaning (e.g. to remove soldering flux or other materials from the production process.) 2. Cleaning conditions should be determined after verifying, through a test run, that the cleaning process does not affect the inductor's characteristics.
Technical considerations	<p>◆Cleaning conditions</p> <ol style="list-style-type: none"> 1. The use of inappropriate solutions can cause foreign substances such as flux residue to adhere to the inductor, resulting in a degradation of the inductor's electrical properties (especially insulation resistance). 2. Inappropriate cleaning conditions (insufficient or excessive cleaning) may detrimentally affect the performance of the inductors. In the case of ultrasonic cleaning, too much power output can cause excessive vibration of the PC board which may lead to the cracking of the inductor or the soldered portion, or decrease the terminal electrodes' strength. Therefore, the following conditions should be carefully checked; <ul style="list-style-type: none"> Ultrasonic output 20W/l or less Ultrasonic frequency 40kHz or less Ultrasonic washing period 5 min. or less
6. Resin coating and mold	
Precautions	<ol style="list-style-type: none"> 1. With some type of resins a decomposition gas or chemical reaction vapor may remain inside the resin during the hardening period or while left under normal storage conditions resulting in the deterioration of the inductor's performance. 2. Thermal expansion and thermal shrinkage characteristics of resins may lead to the deterioration of inductors' performance. 3. When a resin hardening temperature is higher than inductor operating temperature, the stresses generated by the excessive heat may lead to damage in inductors.
7. Handling	
Precautions	<p>◆Breakaway PC boards (splitting along perforations)</p> <ol style="list-style-type: none"> 1. When splitting the PC board after mounting inductors and other components, care is required so as not to give any stresses of deflection or twisting to the board. 2. Board separation should not be done manually, but by using the appropriate devices. <p>◆General handling precautions</p> <ul style="list-style-type: none"> · Always wear static control bands to protect against ESD. · Keep the inductors away from all magnets and magnetic objects. · Use non-magnetic tweezers when handling inductors. · Any devices used with the inductors (soldering irons, measuring instruments) should be properly grounded. · Keep bare hands and metal products (i.e., metal desk) away from inductor electrodes or conductive areas that lead to chip electrodes. · Keep inductors away from items that generate magnetic fields such as speakers or coils. <p>◆Mechanical considerations</p> <p>Be careful not to subject the inductors to excessive mechanical shocks.</p> <ol style="list-style-type: none"> (1) If inductors are dropped on the floor or a hard surface they should not be used. (2) When handling the mounted boards, be careful that the mounted components do not come in contact with or bump against other boards or components.

8. Storage conditions

Precautions	<p>◆Storage To maintain the solderability of terminal electrodes and to keep the packaging material in good condition, care must be taken to control temperature and humidity in the storage area. Humidity should especially be kept as low as possible.</p> <p>·Recommended conditions Ambient temperature: 30°C or below Humidity: 70% RH or below The ambient temperature must be kept below 40°C. Even under ideal storage conditions, solderability of inductor is deteriorated as time passes, so inductors should be used within 6 months from the time of delivery.</p> <p>·Inductor should be kept where no chlorine or sulfur exists in the air.</p>
Technical considerations	<p>◆Storage If the parts are stocked in a high temperature and humidity environment, problems such as reduced solderability caused by oxidation of terminal electrodes and deterioration of taping/packaging materials may take place. For this reason, components should be used within 6 months from the time of delivery. If exceeding the above period, please check solderability before using the inductors.</p>