



贝特卫士®

更好的电路安全卫士!
You build electronics, We safeguard them!

承 认 书

APPROVAL SHEET

编号 No.	9321315278-D/3-B
日期 Date	2020.06.30

客 户 Customer	
-----------------	--

品 名 Product	Box Subminiature Fuse
系 列 Series	932 series

料号 Part No.	规格描述 Specification	备注 Remark
贝特电子 Betterfuse	Square plastic case, Time-Lag current fuse	
客 户 Customer		

环保特别提示 Special instructions for environmental protection
本产品:

供应商-贝特电子 Supplier-Betterfuse	零件承认章 Approval Signet	客 户 Customer	零件承认章 Approval Signet
制 作 Make			
审 核 Check			
确 认 Approval			

联络 Contact			
业务 Sales	电话 Telephone	手机 Cellphone	邮箱 E-mail
零件承认后敬请回签一份给我司留存, 或将承认后的封面传真 (0769-8352 1857) 至我司, 谢谢!			



Document Record						
No.	Date	Modified Content	Page	Edition	Prepared/modified by	Checked by
1	2014.02.14	Draft	6	D	Runsong Zhong	Lianghua Guo
2	2014.04.08	Added TUV certification	6	B/0	Kings Luo	Wenhua Yan
3	2015.02.04	Add 125mA and 250mA CQC certification; Add 200mA I-T Curve	4,15,16	B/1	Kings Luo	Wenhua Yan
4	2015.02.09	Add 8A and 10A CQC certification;	19,20	B/2	Kings Luo	Wenhua Yan
5	2015.06.18	The fuse high to change the 7.6mm	5	B/3	Jeffery	Gem Guo
6	2015.08.04	Update UR certification		B/4	Jeffery	Gem Guo
7	2015.09.09	Update CQC, TUV certification		B/5	Jeffery	Gem Guo
8	2015.11.18	Update the tapping	9	B/6	Jeffery	Lin Gao
9	2015.12.12	Update PSE certification		B/7	Jeffery	Lin Gao
10	2016.01.14	Update I2T value		B/8	Jeffery	Wenhua Yan
11	2016.04.15	Add the 0.16A~0.4A CQC certification	3,7	B/9	Jeffery	Helge
12	2016.8.24	Change the construction		B/10	Jeffery	Wenqiang Luo
13	2017.12.08	Update BSI, SEMKO certification		C/0	J.Q.	Fei Gao
14	2018.03.05	Update TUV certification		C/1	J.Q.	Fei Gao
15	2018.10.08	Change of the inner core and material	4	C/2	Xiang Xiong	Fei Gao
16	2019.02.25	Update UL certification	7	C/3	Xiang Xiong	Fei Gao
17	2019.03.11	Add 6.3A PSE certification	7	C/4	Xiang Xiong	Fei Gao
18	2019.04.24	Add 12A, 12.5A, 15A and 16A IT curve	6	C/5	Xiang Xiong	Fei Gao
19	2019.10.14	Change CQC to CCC		D/0	YaLan Wang	Fei Gao
20	2020.04.23	Update tape drawing		D/1	YaLan Wang	Fei Gao
21	2020.04.24	Add 300V CQC certification		D/2	YaLan Wang	Fei Gao
22	2020.06.30	Update content		D/3	YaLan Wang	Fei Gao

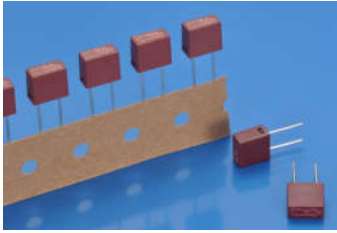

TABLE OF CONTENTS

1. SCOPE AND DESCRIPTION.....	4
2. GENERAL INFORMATION.....	4
3. AGENCY APPROVALS.....	5
4. PART NUMBERING SYSTEM.....	6
5. CONSTRUCTION AND MECHANICAL CHARACTERISTICS.....	7
6. ELECTRICAL SPECIFICATIONS.....	8
7. SOLDERING PARAMETERS.....	10
8. ORDERING INFORMATION.....	10
9. PACKING INFORMATION.....	11



1. SCOPE AND DESCRIPTION



Following electronic product specifications apply to fuses of the 932 series. The 932 series is a subminiature fuse links for over-current protection.

Its main applications are for consumer electronics, LED drivers,

2. GENERAL INFORMATION









General Description

The 932 series provides protection for printed circuit boards used in a large variety of applications that need fuses with time-delay, low breaking capacity. The subminiature device is constructed of a plastic cap and base with a tin plated copper lead wire. It offers excellent mounting characteristics and is 100% tested for cold resistance.

Detailed Features

- Subminiature fuse with time-lag, low breaking capacity
- Small, rectangular and leaded design minimizes board space and eliminates the need for additional mounting components
- Plastic cap / brown thermoplastic fuse body.
- 0.6mm lead wires made of tin plated copper.
- Protection against harmful over-currents in primary and secondary applications.
- Lead-free, Halogen-free, RoHS compliant
- Designed according to IEC 60127

**3. AGENCY APPROVALS**

Agency	Agency File Number	Voltage / Current Rating
	E300003	125V / 250V / 277V / 300V/ 400V:100mA~16A
	40033369	250V AC:630mA;800mA;1A;1.25A;1.6A;2A;2.5A;3.15A;4A;5A;6.3A
	CQC20012242947	300V AC: 500mA;1A;1.25A;1.6A;2A;2.5A;3.15A;4A;5A;6.3A;8A;10A
	2020970207000039	250V AC:125mA;160mA;200mA;250mA;315mA;400mA; 500mA;630mA;800mA;1A;1.25A;1.6A;2A;2.5A;3.15A;4A;5A;6.3A;8A;10A
	PSE15020937 PSE19021462	250V AC:1A;1.25A;1.6A;2A;2.5A;3.15A;4A;5A 250V AC:6.3A
	SU05042-13003 SU05042-13002 SU05042-13001	250VAC:500mA;630mA;800mA;1A;1.25A;1.6A;2A;2.5A; 3.15A ;4A;5A;6.3A
	R 50279350	250VAC:125mA;160mA;200mA;250mA;315mA;400mA;500mA 300VAC:125mA;160mA;200mA;250mA;315mA;400mA;500mA;630mA; 800mA;1A;1.25A;1.6A;2A;2.5A;3.15A;4A;5A;6.3A;8A;10A
	KM 677189	250VAC:3.15A;5A;8A;10A
	1719061	250VAC:3.15A;5A;8A;10A



4. PART NUMBERING SYSTEM

4.1 Part Number

Example: 9321315278

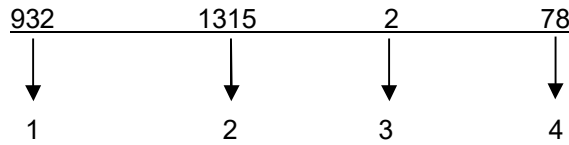

- | | |
|-----------------------------|--|
| 1 .Product Series | 932 |
| 2 .Ampere Rating | 3.15A (see table 4.2 below) |
| 3 .Rated Voltage | 1- 125V
2- 250V
3- 300V
K- 400V |
| 4 .Supplementary Code | see table 4.3 below |

4.2. Ampere / Voltage Rating Table

AMP COGE	CURRENT RATING	VOLTAGE RATING
0100	100mA	125V / 250V / 277V / 300V / 400VAC
0125	125mA	125V / 250V / 277V / 300V / 400VAC
0160	160mA	125V / 250V / 277V / 300V / 400VAC
0200	200mA	125V / 250V / 277V / 300V / 400VAC
0250	250mA	125V / 250V / 277V / 300V / 400VAC
0315	315mA	125V / 250V / 277V / 300V / 400VAC
0400	400mA	125V / 250V / 277V / 300V / 400VAC
0500	500mA	125V / 250V / 277V / 300V / 400VAC
0630	630mA	125V / 250V / 277V / 300V / 400VAC
0800	800mA	125V / 250V / 277V / 300V / 400VAC
1100	1.00A	125V / 250V / 277V / 300V / 400VAC
1125	1.25A	125V / 250V / 277V / 300V / 400VAC
1160	1.60A	125V / 250V / 277V / 300V / 400VAC
1200	2.00A	125V / 250V / 277V / 300V / 400VAC
1250	2.50A	125V / 250V / 277V / 300V / 400VAC
1315	3.15A	125V / 250V / 277V / 300V / 400VAC
1400	4.00A	125V / 250V / 277V / 300V / 400VAC
1500	5.00A	125V / 250V / 277V / 300V / 400VAC
1630	6.30A	125V / 250V / 277V / 300V / 400VAC
1800	8.00A	125V / 250V / 277V / 300V / 400VAC
2100	10.00A	125V / 250V / 277V / 300V / 400VAC
2120	12.00A	125V / 250V / 277V / 300V / 400VAC
2125	12.50A	125V / 250V / 277V / 300V / 400VAC
2150	15.00A	125V / 250V / 277V / 300V / 400VAC
2160	16.00A	125V / 250V / 277V / 300V / 400VAC

4.3. Supplementary Code Table

CODE	DESIGNATION
00	Special products
01	Taping
02	bulk
05	Lead wire:3.5±0.5
06	Lead wire:4±0.5
.	.
.	.
.	.
.	.
78	Taping



5. CONSTRUCTION AND MECHANICAL CHARACTERISTICS

Construction (cross section)

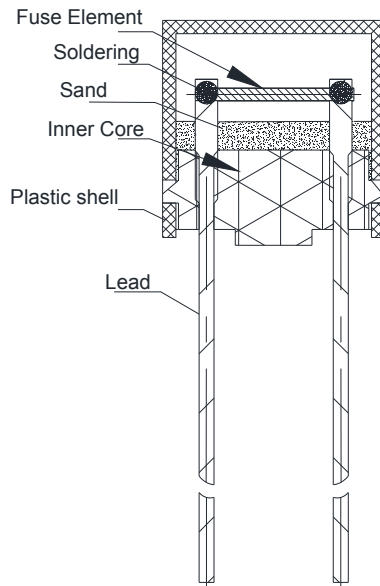

Dimensions (unit: mm)

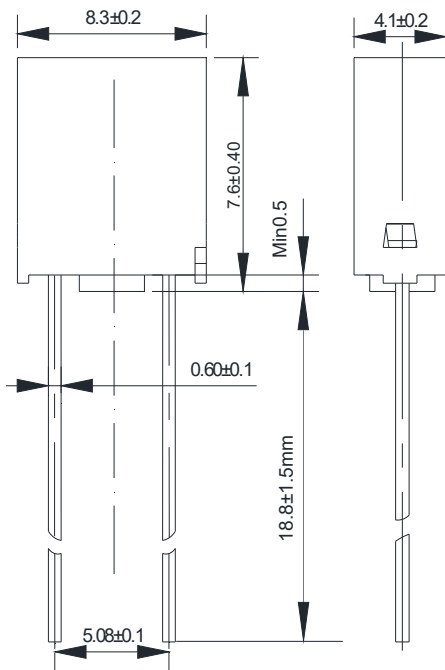

Operating Temperature:

-55°C to +125°C

Storage Conditions:

+10°C to +60°C

Relative humidity: ≤ 75% yearly average
without dew, maximum 30 days at 95%

Vibration Resistance:

24 cycles at 15 min. each (60068-6)

10-60Hz at 0.75mm amplitude

60-2000Hz at 10g acceleration

Long Leads: L=18.8±1.5mm

Short Leads: L=4.3±0.3mm

The dimension of 5.08 ± 0.1mm is the distance between PIN center holes



6. ELECTRICAL SPECIFICATIONS

Time vs Current Characteristics Table

(measured with constant current power supply)

Time vs Current Characteristics:IEC60127					
Rated Current	150%	210%	275%	400%	1000%
100mA~6.3A	>1h	<2min	400ms~10s	150ms~3s	20ms~150ms
8A~10A	>1h	<300s	1s~20s	150ms~3s	20ms~150ms
12A~16A	>1h	<300s	1s~50s	150ms~5s	20ms~150ms

Average Time Current (I-T Curves)

Average Current Curve(I-T Curve)

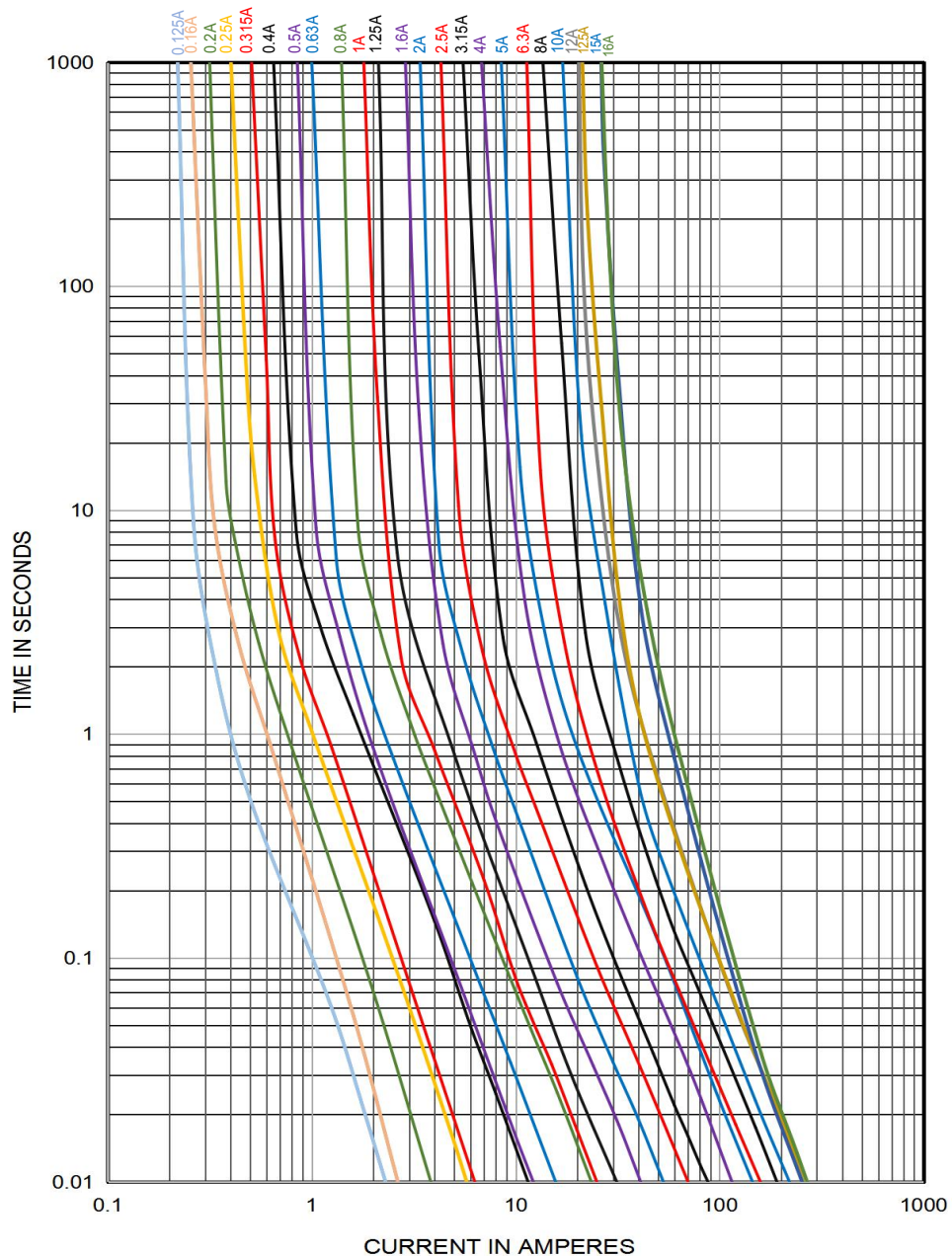



Electrical Characteristics at 25°C

Amp Code	Rated Current	Rated Voltage	Voltage Drop Max(mV)	Max Power Dissipation (mW)	Cold Resistance (mΩ)	Nominal Melting I ² T (A ² sec)	Breaking Capacity	Approvals												
								cURus	VDE	CCC	CQC 300V	PSE	KC	TUV 250V	TUV 300V	BSI	SEMKO			
0100	100mA	250VAC 300VAC 400V AC	350	170	/	/	100A@125V AC 100A@250V AC 50A or10In 300V AC 160A@125V/250V AC 100A@277V/300V/400V AC	•	○	○	○	○	○	○	○	○	○	○	○	○
0125	125mA		300	180	1050~1950	0.053		•	○	•	○	○	○	•	•	○	○	○	○	○
0160	160mA		280	190	903~1677	0.073		•	○	•	○	○	○	•	•	○	○	○	○	○
0200	200mA		260	200	557~1035	0.170		•	○	•	○	○	○	•	•	○	○	○	○	○
0250	250mA		240	220	378~702	0.320		•	○	•	○	○	○	•	•	○	○	○	○	○
0315	315mA		220	250	266~494	0.450		•	○	•	○	○	○	•	•	○	○	○	○	○
0400	400mA		200	280	172~319	1.32		•	○	•	○	○	○	•	•	○	○	○	○	○
0500	500mA		190	310	130~241	1.76		•	○	•	•	○	•	•	•	○	○	○	○	○
0630	630mA		180	360	91.0~169	3.40		•	•	•	○	○	•	○	•	○	○	○	○	○
0800	800mA		160	430	84.0~156	3.60		•	•	•	○	○	•	○	•	○	○	○	○	○
1100	1.00A		140	500	66.5~124	6.80		•	•	•	•	•	•	○	•	○	○	○	○	○
1125	1.25A		130	600	48.9~90.7	14.5		•	•	•	•	•	•	○	•	○	○	○	○	○
1160	1.60A		120	730	32.6~60.5	22.0		•	•	•	•	•	•	○	•	○	○	○	○	○
1200	2.00A		100	870	24.4~45.2	37.0		•	•	•	•	•	•	○	•	○	○	○	○	○
1250	2.50A		100	1000	18.4~34.2	56.2		•	•	•	•	•	•	○	•	○	○	○	○	○
1315	3.15A		100	1200	15.4~28.6	108		•	•	•	•	•	•	○	•	•	•	•	•	•
1400	4.00A		100	1400	10.2~19.0	156		•	•	•	•	•	•	○	•	○	○	○	○	○
1500	5.00A		100	1400	8.05~15.0	275		•	•	•	•	•	•	○	•	•	•	•	•	•
1630	6.30A		100	1400	6.16~11.4	272		•	•	•	•	•	•	○	•	○	○	○	○	○
1800	8.00A		100	1400	4.20~7.80	410		•	○	•	•	○	○	○	•	•	•	•	•	•
2100	10.00A	100	1400	3.22~5.98	486	•	○	•	•	○	○	○	•	•	•	•	•	•		
2120	12.00A	180	4000	2.45~4.55	646	•	○	○	○	○	○	○	○	○	○	○	○	○		
2125	12.50A	180	4000	2.52~4.68	706	•	○	○	○	○	○	○	○	○	○	○	○	○		
2150	15.00A	140	4000	1.89~3.51	635	•	○	○	○	○	○	○	○	○	○	○	○	○		
2160	16.00A	140	4000	1.82~3.38	706	•	○	○	○	○	○	○	○	○	○	○	○	○		

- Notes:**
1. Permissible continuous operating current is ≤100% at ambient temperature of 23°C (73.4°F)
 2. For certification, the cURus by 125/250/277V/300V/400V, the TUV by 250/300V, the others by 250V.
 3. The current values used for calculating I²T should be within the standard range of 8ms ~ 10ms.

Temperature Derating Curve

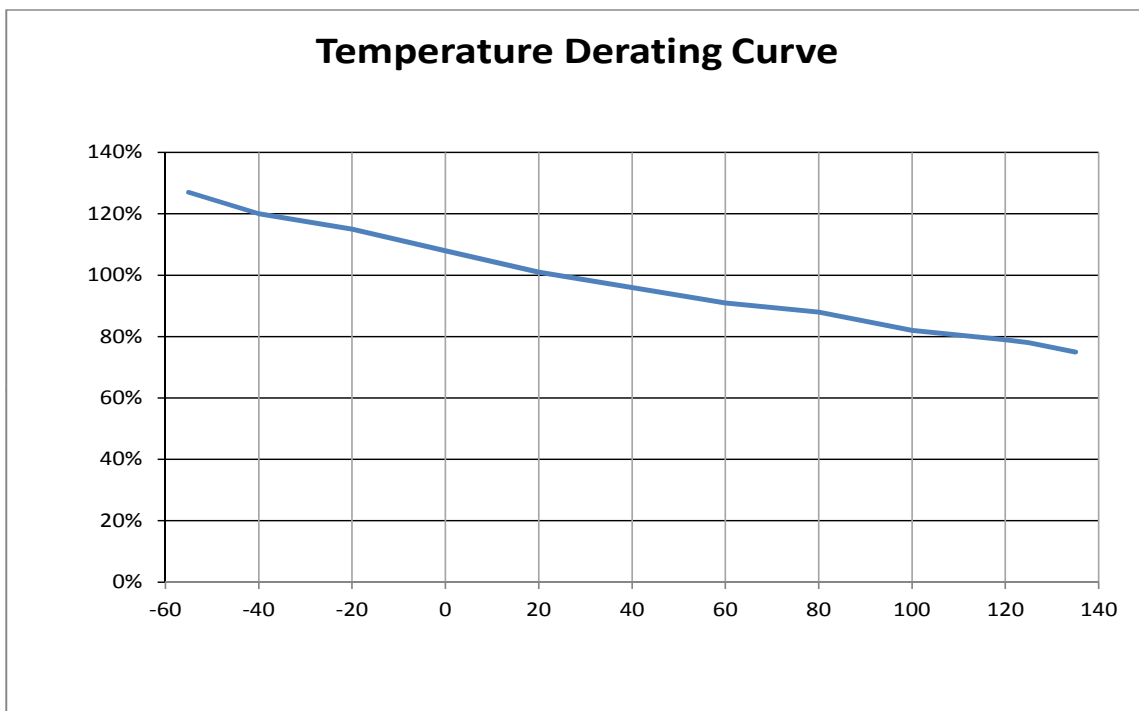

Calculation for ideal fuse selection = $\frac{\text{Operating Current (A)}}{\text{Rating (\%} \times 0.75)}$



7.SOLDERING PARAMETERS

260±5°C.≤5 sec (Wave Soldering)

350°C.≤3 sec (Hand Soldering)

Soldering Peak:

260±5°C - 10 sec (IEC 60068-20)

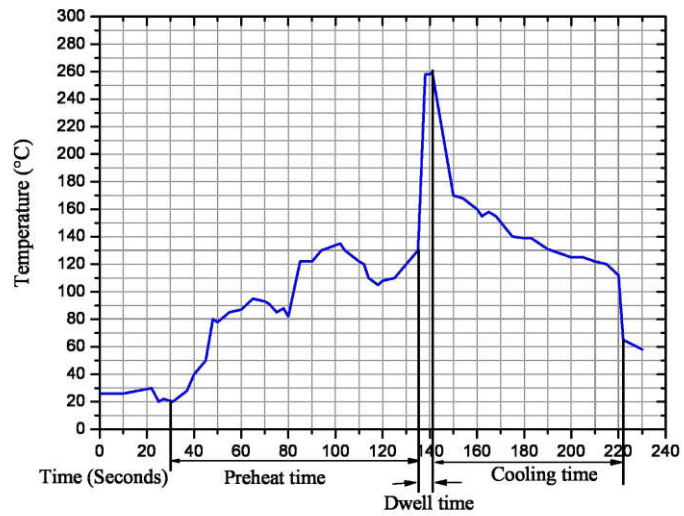

8.ORDERING INFORMATION

The following information are necessary in order to place your order with us correctly:

Series	Amp Code	Supplementary Code	Qty
932			



9.PACKING INFORMATION

Taping detail Unit:mm

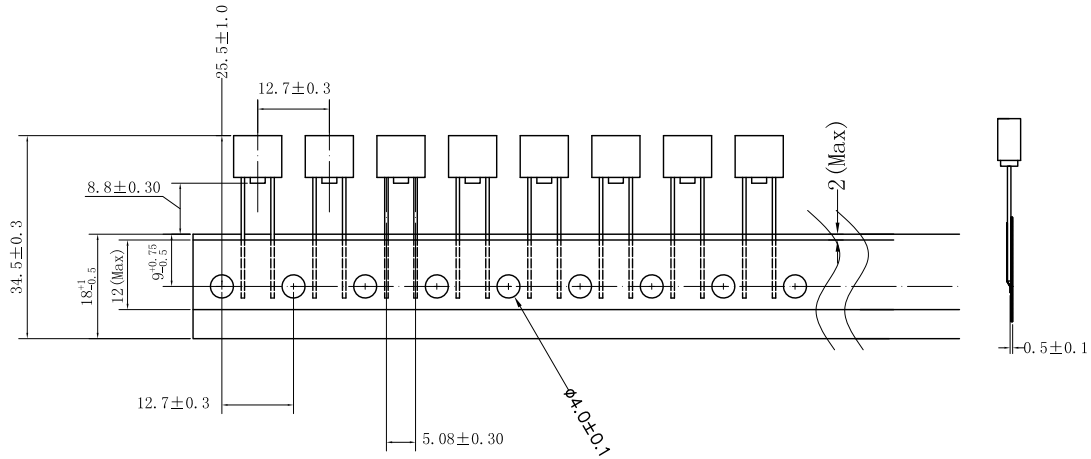

Inner Packaging Box

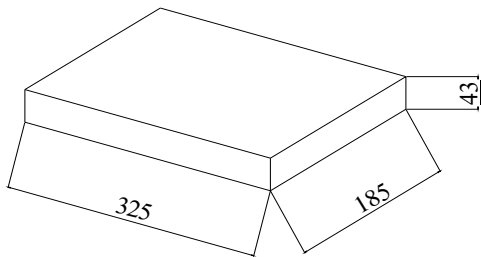

Master Carton

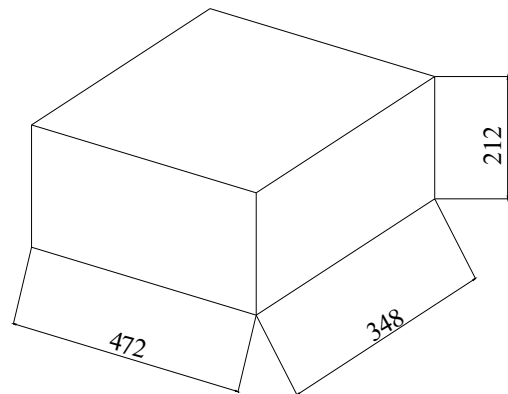

Net Weight (1000pcs+Taping)	0.54Kg	Master Carton Weight	6.10Kg
Qty Per Box	1000pcs	Qty Per Carton	10000pcs

© Dongguan Better Electronics Technology Co.,Ltd.

东莞市贝特电子科技股份有限公司

Room 601 of 16 Block, Xinzhu Yuan, No.4, Xinzhu Road, Songshanlake Hightech Industrial Development Zone, Dongguan City, Guangdong P.R.C
中国广东省东莞市松山湖国家高新技术产业开发区新竹路4号新竹苑16座办公601

Tel: +86 769-2307 8212 Fax: +86 769-8352 1857

Web: www.betterfuse.com

Email: info@betterfuse.com