



贝特卫士®

更好的电路安全卫士!  
You build electronics, We safeguard them!

# 承 认 书

## APPROVAL SHEET

编号 No.	5231160200-B/5-B
日期 Date	2020.04.10

客 户 Customer	
-----------------	--

品 名 Product	Cartridge Fuse-link
系 列 Series	523 Series

料号 Part No.	规格描述 Specification	备注 Remark
贝特电子 Betterfuse		
客 户 Customer		

环保特别提示 Special instructions for environmental protection
本产品:

供应商-贝特电子 Supplier-Betterfuse	零件承认章 Approval Signet	客 户 Customer	零件承认章 Approval Signet
制 作 Make	YaLan Wang		
审 核 Check	Fei Gao		
确 认 Approval	Jun Li		

联络 Contact			
业务 Sales	电话 Telephone	手机 Cellphone	邮箱 E-mail
零件承认后敬请回签一份给我司留存, 或将承认后的封面传真(0769-8352 1857)至我司, 谢谢!			



Document Record						
No.	Date	Modified Content	Page	Edition	Prepared/modified by	Checked by
1	2012.10.25	Draft	8	A/0	Runsong Zhong	Lianghua Guo
2	2014.07.28	Release Edition	8	B/0	Kings Luo	Wenhua Yan
3	2015.05.05	Lead standard length: 38mm change as 30mm	4	B/1	Kings Luo	Wenhua Yan
4	2015.07.30	Update UR certification		B/2	Jeffery	Gem Guo
5	2017.01.05	Update CCC certification		B/3	J.Q.	Fei Gao
6	2019.10.29	Update CCC certification		B/4	YaLan Wang	Fei Gao
7	2020.04.10	Update TUV certification		B/5	YaLan Wang	Fei Gao
8						
9						
10						
11						
12						

## TABLE OF CONTENTS

1. SCOPE AND DESCRIPTION.....	3
2. GENERAL INFORMATION.....	3
3. AGENCY APPROVALS.....	3
4. PART NUMBERING SYSTEM.....	4
5. MECHANICAL SPECIFICATIONS.....	5
6. ELECTRICAL SPECIFICATIONS.....	6
7. SOLDERING PARAMETERS.....	8
8. ORDERING INFORMATION.....	8
9. PACKING INFORMATION.....	9
10. APPENDIX.....	10



## 1. SCOPE AND DESCRIPTION



Following electronic product specifications apply to fuses of the 523 series. The 523 series is a cartridge fuse link for over-current protection.

With its high breaking capacity the 523 fuse series is ideal for supplementary protection in electrical appliances and equipment to provide excellent protection for components or circuits.

## 2. GENERAL INFORMATION





### General Description

The 523 series quick-acting fuse with high breaking capacity for use with printed circuit boards is used in a large variety of applications. This 5x20mm device is constructed of a ceramic tube with electro-plated brass end caps. The 523 series with 250 VAC rating and 1500 Ampere breaking, offers excellent quality and is 100% tested for cold resistance and precise length.

### Detailed Features

- Miniature fuse with quick-acting, high breaking capacity
- 5mm x 20mm physical dimensions
- Ceramic tube, encapsulated design with nickel - plated brass end caps
- Optional axial leads are  $\Phi 0.65\text{mm} \times 38\text{mm}$  at 500mA~6.3A,  $\Phi 0.8\text{mm} \times 38\text{mm}$  at 8A~10A
- Protection against harmful over-currents in primary and secondary applications.
- Lead-free, Halogen-free, RoHS compliant
- Designed compliant to IEC 60127-2/ I

## 3. AGENCY APPROVALS

Agency	Agency File Number	Ampere/ Voltage Range
	40025669	250VAC: 500mA; 1.6A; 3.15A; 6.3A; 8A; 10A
	CQC08012026399	250V: 10A
	E300003	125V AC/250VAC: 500mA~10A
	2008010207298390	250V: 500mA; 1A; 3.15A; 6.3A; 10A
	J 50457959	250VAC: 500mA~25A



## 4. PART NUMBERING SYSTEM

### 4.1 Part Number

Example: 5231160200

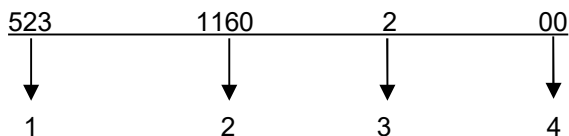

- 1 ..... Product Series ..... 523
- 2 ..... Ampere Rating/ Code ..... 1.6A (see table 4.3 below)
- 3 ..... Voltage Rating ..... 2 – 250V  
1 – 125V
- 4 ..... Packaging Code ..... (see table 4.2 below)

### 4.2 Packaging Code Table

CODE	DESIGNATION
00	Normal product
01	Octangular cap $\Phi$ 0.65mm
02	Round Cap $\Phi$ 0.65mm
03	Octangular cap $\Phi$ 0.8mm
04	Round Cap $\Phi$ 0.8mm
05	Octangular cap $\Phi$ 1.0mm
06	Round Cap $\Phi$ 1.0mm

### 4.3. Ampere Rating Table

AMP CODE	CURRENT RATING	VOLTAGE RATING
0500	500mA	125V/250V
0630	630mA	125V/250V
0800	800mA	125V/250V
1100	1A	125V/250V
1125	1.25A	125V/250V
1160	1.6A	125V/250V
1200	2A	125V/250V
1250	2.5A	125V/250V
1315	3.15A	125V/250V
1400	4A	125V/250V
1500	5A	125V/250V
1630	6.3A	125V/250V
1800	8A	125V/250V
2100	10A	125V/250V



5. MECHANICAL SPECIFICATIONS

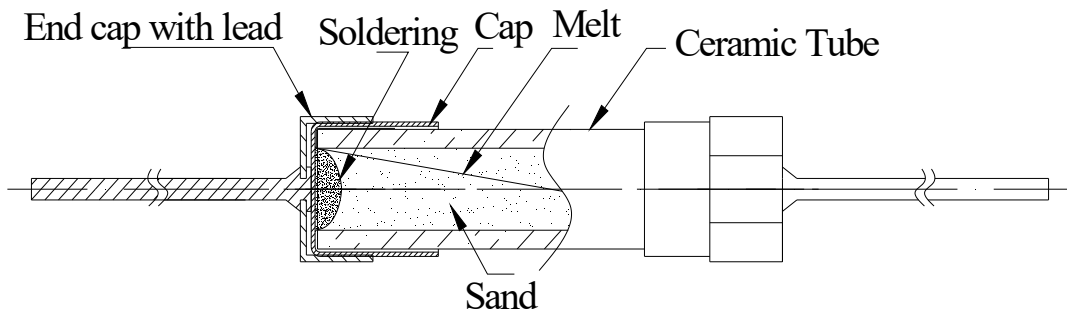
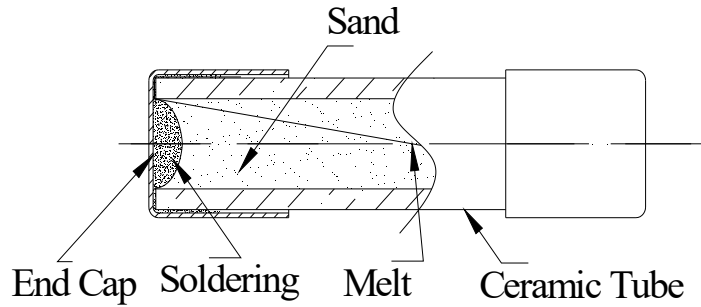

Dimensions (units: mm)

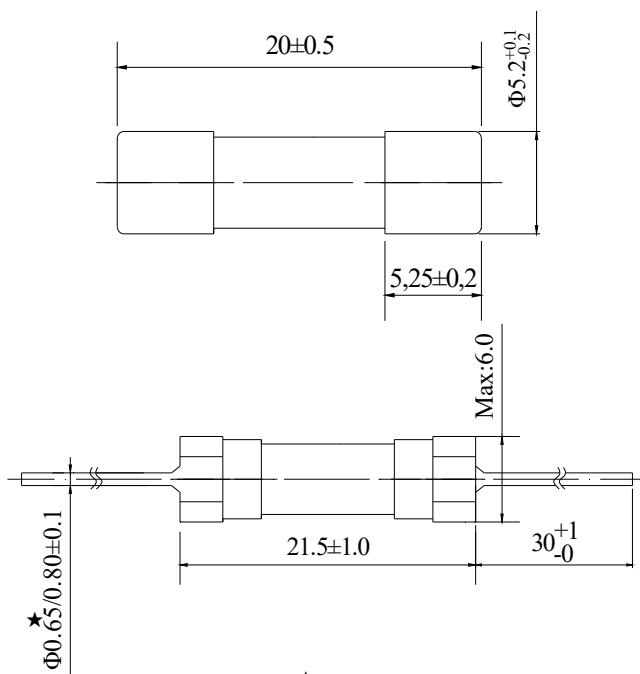

Note: ★  
500mA~7.0A \*\* Φ0.65mm  
8.0A~10A \*\* Φ0.80mm

Operating Temperature:

-55°C to 125°C

Storage Conditions:

+10°C to +60°C

Relative humidity: ≤ 75% yearly average  
without dew, maximum 30 days at 95%

Vibration Resistance:

24 cycles at 15 min. each (60068-6)

10-60Hz at 0.75mm amplitude

60-2000Hz at 10g acceleration



## 6. ELECTRICAL SPECIFICATIONS

### Time vs Current Characteristics Table

(measured with constant current power supply)

Time vs Current Characteristics: IEC 60127-2/ I					
Rated Current	150%	210%	275%	400%	1000%
500mA~4.0A	>1h	<30min	10ms~2s	3ms~300ms	≤20ms
4.1A~6.3A	>1h	<30min	10ms~3s	3ms~300ms	≤20ms
6.4A~10A	>1h	<30min	40ms~20s	10ms~1s	≤30ms

### Average Time Current (I-T) Curves

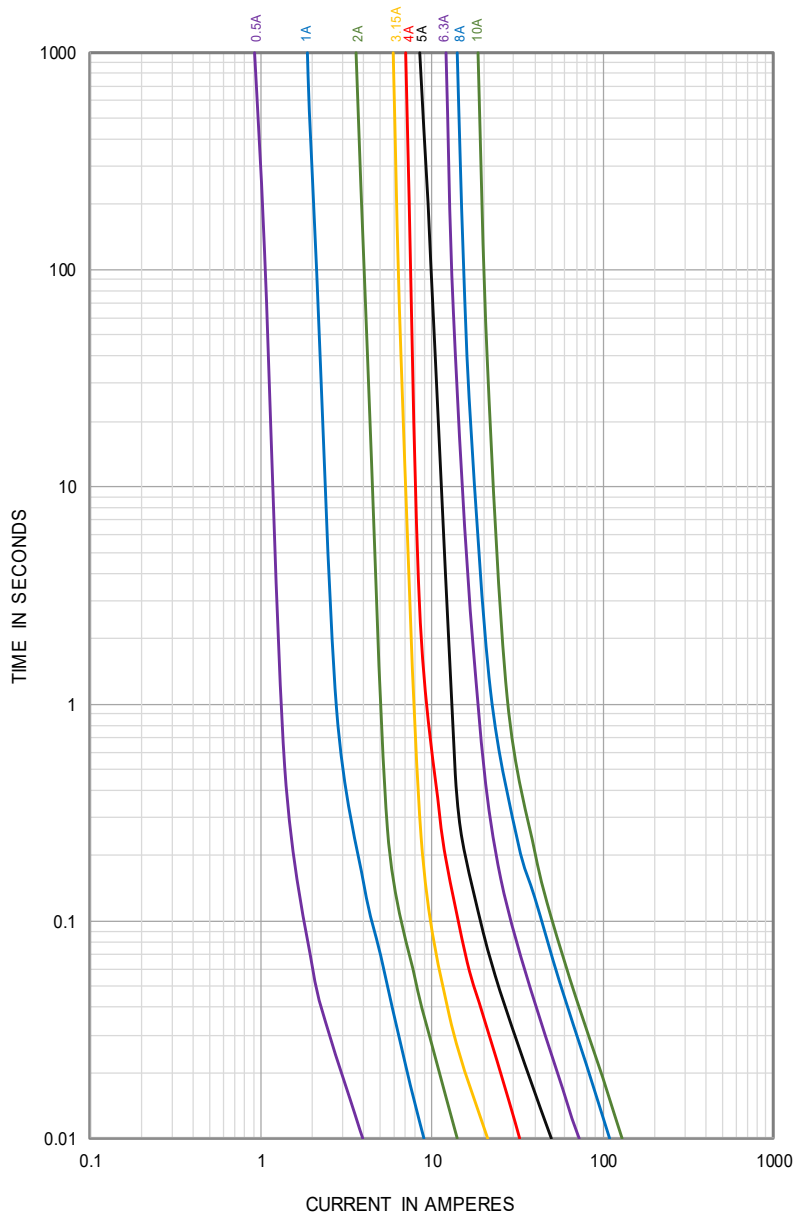



### Electrical characteristics

Electrical Characteristics at 25°C												
Amp Code	Rated Current	Max. Voltage	Voltage Drop Max(mV)	Max Power Dissipation (mW)	Typical Code Resistance (mΩ)	Nominal Melting I <sup>2</sup> T (A <sup>2</sup> sec)	Breaking Capacity	Approvals				
								VDE	CQC	cURus	CCC	TUV
0500	500mA	250V AC	1800	2.5	530	0.152	1500A@250V AC 10KA@125V AC 50~60Hz COSΦ=0.7~0.8	●	○	●	●	●
0630	630mA		1500	2.5	340	0.24		○	○	●	○	●
0800	800mA		1200	2.5	230	0.533		○	○	●	○	●
1100	1.00A		1000	2.5	178	0.81		○	○	●	●	●
1125	1.25A		800	4.0	125	1.23		○	○	●	○	●
1160	1.60A		600	4.0	96	1.3		●	○	●	○	●
1200	2.00A		500	4.0	58	1.96		○	○	●	○	●
1250	2.50A		400	4.0	46	3.06		○	○	●	○	●
1315	3.15A		350	4.0	34	4.41		●	○	●	●	●
1400	4.00A		300	4.0	32.5	10.43		○	○	●	○	●
1500	5.00A		250	4.0	23.5	25		○	○	●	○	●
1630	6.30A		200	4.0	15.5	53.3		●	○	●	●	●
1800	8.00A		200	4.0	11.5	121		●	○	●	○	●
2100	10.00A		200	4.0	6.8	136		●	○	●	●	●

**Notes:** (1) Permissible continuous operating current is ≤100% at ambient temperature of 23°C (73.4°F)  
 (2) The cURus certification by 125V and 250V; the others certification only by 250V.

### Temperature Derating Curve

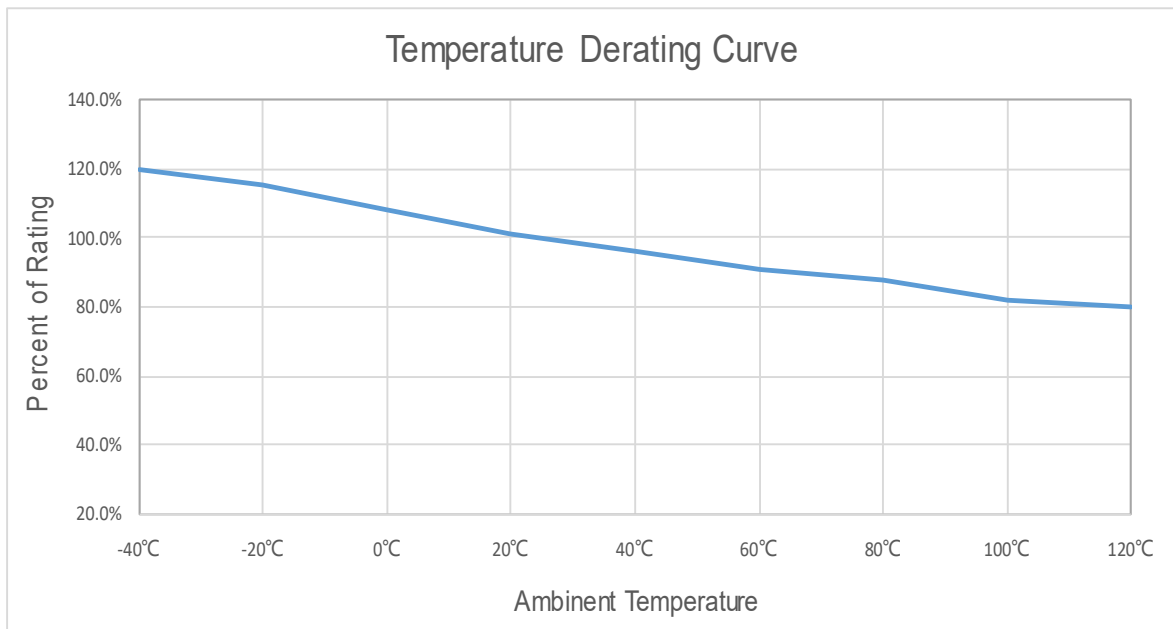

$$\text{Calculation for ideal fuse selection} = \frac{\text{Operating Current (A)}}{\text{Rating (\%} \times 0.75)}$$



## 7. SOLDERING PARAMETERS

260°C. ≤5 sec (Wave Soldering)

350°C. ≤3 sec (Hand Soldering)

Soldering Peak:

260°C - 10 sec (IEC 60068-20)

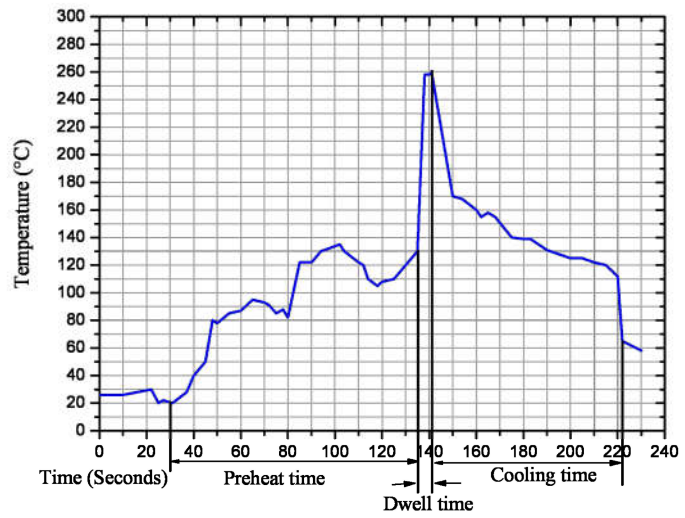

## 8. ORDERING INFORMATION

The following information are necessary in order to place your order with us correctly:

Series	Amp Code	Supplementary Code	Qty
523			





**9. PACKING INFORMATION**

**Packing details**

Plastic bag

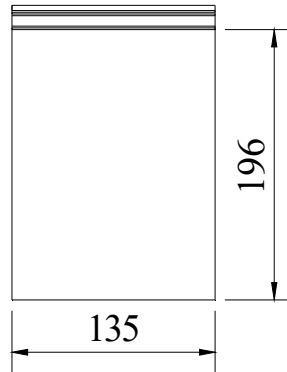

Inner Box

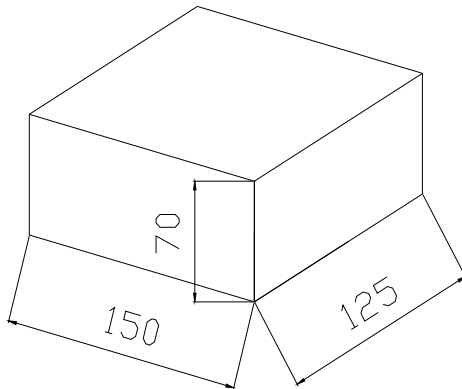

Master Carton

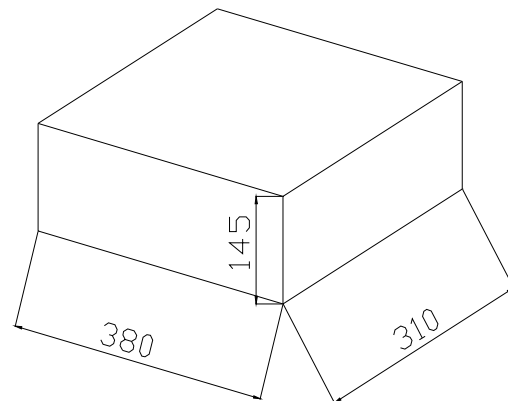

Net Weight (100pcs/bag)	550g	Inner box weight	1.2kg	Master Carton Weight	12.5kg
Qty per bag	500pcs	Qty per box	1000pcs	Qty per carton	10000pcs

© Dongguan Better Electronics Technology Co.,ltd.

东莞市贝特电子科技股份有限公司

Room 601 of 16 Block, Xinzhu Yuan, No.4, Xinzhu Road, Songshanlake Hightech Industrial Development Zone, Dongguan City, Guangdong P.R.C  
中国广东省东莞市松山湖国家高新技术产业开发区新竹路4号新竹苑16座办公601

Tel: +86 769-2307 8212 Fax: +86 769-8352 1857

Web: [www.betterfuse.com](http://www.betterfuse.com)

Email: [info@betterfuse.com](mailto:info@betterfuse.com)



10. APPENDIX

**Product IQ**

Tags

Organize your personal workspace with custom tags

LEARN MORE

Dashboard / Search / FUSES, SUPPLEMENTAL - COMPONENT | UL Product IQ

**JDYX2.E300003 - FUSES, SUPPLEMENTAL - COMPONENT**

**DETAILS**

File No.: E300003

UL Category (CCN): [JDYX2](#)

Document Type: Listing

Parent Category (CCN): [JCQR2](#)

**RESOURCES**

- [UL Confirmation Letter](#)
- [Guide Info \(JDYX2\)](#)

**TAGS**

Document
Company Information
Related Information

## Fuses, Supplemental - Component

See General Information for Fuses, Supplemental - Component

**DONGGUAN BETTER ELECTRONICS TECHNOLOGY CO LTD** E300003

Rm 601 Of 16 Bk  
Xinzhu Yuan No 4 Xinzhu Rd  
Songshan Lake Hightech Industrial Development Zone  
Dongguan, Guangdong 523808 CHINA

**Supplemental fuses**

Cat. No.	Size mm(in)	Amps (A)	Volts (V)	Interrupting Rating (A)
<b>523</b>	5 x 20 (0.20 x 0.79)	0.5 - 10	125Vac	10000
		0.5 - 10	250Vac	1500

Marking: Company name and model designation. Last Updated on 2019-07-05

The appearance of a company's name or product in this database does not in itself assure that products so identified have been manufactured under UL's Follow-Up Service. Only those products bearing the UL Mark should be considered to be Certified and covered under UL's Follow-Up Service. Always look for the Mark on the product.

UL permits the reproduction of the material contained in the Online Certification Directory subject to the following conditions: 1. The Guide Information, Assemblies, Constructions, Designs, Systems, and/or Certifications (files) must be presented in their entirety and in a non-misleading manner, without any manipulation of the data (or drawing). 2. The statement "Reprinted from the Online Certifications Directory with permission from UL" must appear adjacent to the extracted material. In addition, the reprinted material must include a copyright notice in the following format: "© 2019 UL LLC"





# 中国国家强制性产品认证证书

证书编号：2008010207298390

委托人名称、地址

东莞市贝特电子科技股份有限公司  
东莞市松山湖高新技术产业开发区新竹路4号新竹苑16座办公601

生产者（制造商）名称、地址

东莞市贝特电子科技股份有限公司  
东莞市松山湖高新技术产业开发区新竹路4号新竹苑16座办公601

生产企业名称、地址

东莞市贝特电子科技股份有限公司  
东莞市寮步镇横坑南门村第二工业区C座、B座

产品名称和系列、规格、型号

管状熔断体  
523 F500mAH250V,523 F1AH250V,523 F3.15AH250V,523 F6.3AH250V

产品标准和技术要求

GB9364.1-1997; GB/T9364.2-1997

上述产品符合强制性产品认证实施规则 CNCA-C02-01:2014 的要求，特发此证。

发证日期：2017年12月21日 有效期至：2022年12月21日

证书有效期内本证书的有效性依据发证机构的定期监督获得保持。

本证书为变更证书，证书首次颁发日期：2008年10月16日

本证书的相关信息可通过国家认监委网站 [www.cnca.gov.cn](http://www.cnca.gov.cn) 查询



主任： 



## 中国质量认证中心





# CERTIFICATE FOR CHINA COMPULSORY PRODUCT CERTIFICATION

**CERTIFICATE NO.: 2008010207298390**

## **NAME AND ADDRESS OF THE APPLICANT**

Dongguan Better Electronics Technology Co., Ltd.  
Room 601 of 16 Block, Xinzhu Yuan, No 4, Xinzhu Road, Songshanlake Hightech Industrial  
Development Zone, Dongguan City, Guangdong Province, PRC

## **NAME AND ADDRESS OF THE MANUFACTURER**

Dongguan Better Electronics Technology Co., Ltd.  
Room 601 of 16 Block, Xinzhu Yuan, No 4, Xinzhu Road, Songshanlake Hightech Industrial  
Development Zone, Dongguan City, Guangdong Province, PRC

## **NAME AND ADDRESS OF THE FACTORY**

Dongguan Better Electronics Technology Co., Ltd.  
NanMen Village, HengKeng Administrative Zone LiaoBu Town, Dongguan, Guangdong, China.

## **PRODUCT NAME, MODEL AND SPECIFICATION**

Cartridge Fuse-link  
523 F500mAH250V, 523 F1AH250V, 523 F3.15AH250V, 523 F6.3AH250V

## **THE STANDARDS AND TECHNICAL REQUIREMENTS FOR THE PRODUCTS**

GB9364.1-1997; GB/T9364.2-1997

This is to certify that the above mentioned product(s) complies with the requirements of  
implementation rules for compulsory certification (REFNO.CNCA-C02-01:2014).

**Valid from:** Dec.21,2017

**Valid until:** Dec.21,2022

The validity of the certificate is subject to positive result of the regular follow up  
inspection by issuing certification body until the expiry date.

Date of original issued: Oct.16,2008

The certificate information is available through CNCA's website: [www.cnca.gov.cn](http://www.cnca.gov.cn)



President:

Wang Kejiao



## **CHINA QUALITY CERTIFICATION CENTRE**





# 中国国家强制性产品认证证书

证书编号：2008010207298390

委托人名称、地址

东莞市贝特电子科技股份有限公司  
东莞市松山湖高新技术产业开发区新竹路4号新竹苑16座办公601

生产者（制造商）名称、地址

东莞市贝特电子科技股份有限公司  
东莞市松山湖高新技术产业开发区新竹路4号新竹苑16座办公601

生产企业名称、地址

东莞市贝特电子科技股份有限公司  
东莞市寮步镇横坑南门村第二工业区C座、B座

产品名称和系列、规格、型号

管状熔断体

523 F500mAH250V、523 F1AH250V、523 F3.15AH250V、523 F6.3AH250V、523 F10AH250V

产品标准和技术要求

GB/T9364.1-2015;GB/T9364.2-2018

上述产品符合强制性产品认证实施规则 CNCA-C02-01:2014 的要求，  
特发此证。

发证日期：2019年10月25日 有效期至：2022年12月21日

证书有效期内本证书的有效性依据发证机构的定期监督获得保持。

本证书为变更证书，证书首次颁发日期：2008年10月16日

本证书的相关信息可通过国家认监委网站 [www.cnca.gov.cn](http://www.cnca.gov.cn) 查询



主任：

陆梅



## 中国质量认证中心



# CERTIFICATE FOR CHINA COMPULSORY PRODUCT CERTIFICATION

**CERTIFICATE NO.: 2008010207298390**

## **NAME AND ADDRESS OF THE APPLICANT**

Dongguan Better Electronics Technology Co., Ltd.  
Room 601 of 16 Block, Xinzhu Yuan, No 4, Xinzhu Road, Songshanlake Hightech Industrial  
Development Zone, Dongguan City, Guangdong Province, PRC

## **NAME AND ADDRESS OF THE MANUFACTURER**

Dongguan Better Electronics Technology Co., Ltd.  
Room 601 of 16 Block, Xinzhu Yuan, No 4, Xinzhu Road, Songshanlake Hightech Industrial  
Development Zone, Dongguan City, Guangdong Province, PRC

## **NAME AND ADDRESS OF THE FACTORY**

Dongguan Better Electronics Technology Co., Ltd.  
NanMen Village, HengKeng Administrative Zone LiaoBu Town, Dongguan, Guangdong, China.

## **PRODUCT NAME, MODEL AND SPECIFICATION**

Cartridge Fuse-link  
523 F500mAH250V、523 F1AH250V、523 F3.15AH250V、523 F6.3AH250V、523 F10AH  
250V

## **THE STANDARDS AND TECHNICAL REQUIREMENTS FOR THE PRODUCTS**

GB/T9364.1-2015;GB/T9364.2-2018

This is to certify that the above mentioned product(s) complies with the requirements of  
implementation rules for compulsory certification(REFNO.CNCA-C02-01:2014).

**Valid from:** Oct.25,2019

**Valid until:** Dec.21,2022

The validity of the certificate is subject to positive result of the regular follow up  
inspection by issuing certification body until the expiry date.

Date of original issued: Oct.16,2008

The certificate information is available through CNCA's website: [www.cnca.gov.cn](http://www.cnca.gov.cn)



President:

Lu Mei



## **CHINA QUALITY CERTIFICATION CENTRE**

## ZEICHENGENEHMIGUNG MARKS APPROVAL

Dongguan Better Electronics  
Technology Co., Ltd.  
Room 601 of 16 Block, Xinzhu Yuan  
No 4, Xinzhu Road  
523808 DONGGUAN  
CHINA

ist berechtigt, für ihr Produkt /  
*is authorized to use for their product*

**G-Sicherungseinsatz**  
**Cartridge fuse-link**

die hier abgebildeten markenrechtlich geschützten Zeichen  
für die ab Blatt 2 aufgeführten Typen zu benutzen /  
*the legally protected Marks as shown below for the types referred to on page 2 ff.*



Geprüft und zertifiziert nach /  
*Tested and certified according to*

DIN EN 60127-1 (VDE 0820-1):2015-12; EN 60127-1:2006+A1:2011+A2:2015  
DIN EN 60127-2 (VDE 0820-2):2015-07; EN 60127-2:2014  
IEC 60127-1:2006  
IEC 60127-1:2006/AMD1:2011  
IEC 60127-1:2006/AMD2:2015  
IEC 60127-2:2014



Aktenzeichen: 5015514-1170-0006 / 228748

File ref.:

Ausweis-Nr. 40025669

Blatt 1

Certificate No.

Page

Weitere Bedingungen siehe Rückseite und Folgeblätter /  
*further conditions see overleaf and following pages*

Offenbach, 2008-10-27

(letzte Änderung / updated 2016-11-21 )

VDE Prüf- und Zertifizierungsinstitut GmbH  
VDE Testing and Certification Institute  
Zertifizierungsstelle / Certification

VDE Zertifikate sind nur gültig bei Veröffentlichung unter:  
VDE certificates are valid only when published on:

<http://www.vde.com/zertifikat>  
<http://www.vde.com/certificate>

Name und Sitz des Genehmigungs-Inhabers / *Name and registered seat of the Certificate holder*

Dongguan Better Electronics Technology Co., Ltd., Room 601 of 16 Block, Xinzhu Road,  
523808 DONGGUAN, Guangdong, CHINA

Aktenzeichen / *File ref.*

5015514-1170-0006 / 228748 / CC2 / EUL

letzte Änderung / *updated*

2016-11-21

Datum / *Date*

2008-10-27

Dieses Blatt gilt nur in Verbindung mit Blatt 1 des Zeichengenehmigungsausweises Nr. 40025669.

*This supplement is only valid in conjunction with page 1 of the Certificate No. 40025669.*

## G-Sicherungseinsatz Cartridge fuse-link

Typ(en) / *Type(s)*

### 523-Serie(s)

Bemessungsspannung  
*Rated voltage*

AC 250 V

Bemessungsstrom  
*Rated current*

500 mA; 1,6 A; 3,15 A; 6,3 A; 8 A; 10 A

Normblatt  
*Standard sheet*

1

Maße in mm  
*Dimension in mm*

5 x 20

Kennzeichnung der Charakteristik  
*Characteristic symbol*

F

Kennzeichnung des Ausschaltvermögens  
*Breaking capacity symbol*

H

Bemessungsausschaltvermögen  
*Rated breaking capacity*

1500 A

Zeit/Strom-Charakteristik  
*Time/current-characteristic*

flink  
*quick-acting*

Fortsetzung siehe Blatt 3 /  
*continued on page 3*



Name und Sitz des Genehmigungs-Inhabers / *Name and registered seat of the Certificate holder*

Dongguan Better Electronics Technology Co., Ltd., Room 601 of 16 Block, Xinzhu Yuan, No 4, Xinzhu Road,  
523808 DONGGUAN, Guangdong, CHINA

Aktenzeichen / *File ref.*

5015514-1170-0006 / 228748 / CC2 / EUL

letzte Änderung / *updated*

2016-11-21

Datum / *Date*

2008-10-27

Dieses Blatt gilt nur in Verbindung mit Blatt 1 des Zeichengenehmigungsausweises Nr. 40025669.

*This supplement is only valid in conjunction with page 1 of the Certificate No. 40025669.*

Anmerkung  
*Remark*

Die Prüfspannung in Abschnitt 9.2 war DC 125 V.  
*The test voltage in clause 9.2 was DC 125 V.*

---

Dieser Zeichengenehmigungs-Ausweis bildet eine Grundlage für die EG-Konformitätserklärung und CE-Kennzeichnung durch den Hersteller oder dessen Bevollmächtigten und bescheinigt die Konformität mit den grundlegenden Schutzanforderungen der **EG-Niederspannungsrichtlinie 2014/35/EU**.

*This Marks Approval is a basis for the EC Declaration of Conformity and the CE Marking by the manufacturer or his agent and proves the conformity with the essential safety requirements of the **EC Low-Voltage Directive 2014/35/EU**.*

VDE Prüf- und Zertifizierungsinstitut GmbH  
*VDE Testing and Certification Institute*  
Fachgebiet CC2  
*Section CC2*

# VDE Prüf- und Zertifizierungsinstitut Zeichengenehmigung

Ausweis-Nr. / Beiblatt /  
Certificate No. Supplement  
40025669

Name und Sitz des Genehmigungs-Inhabers / *Name and registered seat of the Certificate holder*

Dongguan Better Electronics Technology Co., Ltd., Room 601 of 16 Block, Xinzhu Yuan, No 4, Xinzhu Road,  
523808 DONGGUAN, Guangdong, CHINA

Aktenzeichen / *File ref.*

5015514-1170-0006 / 228748 / CC2 / EUL

letzte Änderung / *updated*

2016-11-21

Datum / *Date*

2008-10-27

Dieses Beiblatt ist Bestandteil des Zeichengenehmigungsausweises Nr. 40025669.

*This supplement is part of the Certificate No. 40025669.*

## G-Sicherungseinsatz Cartridge fuse-link

Fertigungsstätte(n)  
*Place(s) of manufacture*

Referenz/*Reference*  
**30017543**

Dongguan Better Electronics  
Technology Co., Ltd.  
Nanmen Village  
Hengkeng Administrative Zone  
523413 LIAOBU TOWN, DONGGUAN  
Guangdong  
CHINA

VDE Prüf- und Zertifizierungsinstitut GmbH  
*VDE Testing and Certification Institute*  
Fachgebiet CC2  
*Section CC2*



Name und Sitz des Genehmigungs-Inhabers / *Name and registered seat of the Certificate holder*

Dongguan Better Electronics Technology Co., Ltd., Room 601 of 16 Block, Xinzhu Road,  
523808 DONGGUAN, Guangdong, CHINA

Aktenzeichen / *File ref.*

5015514-1170-0006 / 228748 / CC2 / EUL

letzte Änderung / *updated*

2016-11-21

Datum / *Date*

2008-10-27

Dieses Blatt gilt nur in Verbindung mit Blatt 1 des Zeichengenehmigungsausweises Nr. 40025669.

*This supplement is only valid in conjunction with page 1 of the Certificate No. 40025669.*

## **Genehmigung zum Benutzen des auf Seite 1 abgebildeten markenrechtlich geschützten Zeichens des VDE:**

Grundlage für die Benutzung sind die Allgemeinen Geschäftsbedingungen (AGB) der VDE Prüf- und Zertifizierungsinstitut GmbH ([www.vde.com\AGB-Institut](http://www.vde.com\AGB-Institut)). Das Recht zur Benutzung erstreckt sich nur auf die bezeichnete Firma mit den genannten Fertigungsstätten und die oben aufgeführten Produkte mit den zugeordneten Bezeichnungen. Die Fertigungsstätte muss so eingerichtet sein, dass eine gleichmäßige Herstellung der geprüften und zertifizierten Ausführung gewährleistet ist.

Die Genehmigung ist so lange gültig wie die VDE-Bestimmungen gelten, die der Zertifizierung zugrunde gelegen haben, sofern sie nicht auf Grund anderer Bedingungen aus der VDE Prüf- und Zertifizierungsordnung (PM102) zurückgezogen werden muss.

Der Gültigkeitszeitraum einer VDE-GS-Zeichengenehmigung kann auf Antrag verlängert werden. Bei gesetzlichen und / oder normativen Änderungen kann die VDE-GS-Zeichengenehmigung ihre Gültigkeit zu einem früheren als dem angegebenen Datum verlieren.

Produkte, die das Biozid Dimethylfumarat (DMF) enthalten, dürfen gemäß der Kommissionsentscheidung 2009/251/EG nicht mehr in den Verkehr gebracht oder auf dem Markt bereitgestellt werden.

Der VDE-Zeichengenehmigungsausweis wird ausschließlich auf der ersten Seite unterzeichnet.

### **Approval to use the legally protected Mark of the VDE as shown on the first page:**

*Basis for the use are the general terms and conditions of the VDE Testing and Certification Institute ([www.vde.com\terms-institute](http://www.vde.com\terms-institute)). The right to use the mark is granted only to the mentioned company with the named places of manufacture and the listed products with the related type references. The place of manufacture shall be equipped in a way that a constant manufacturing of the certified construction is assured.*

*The approval is valid as long as the VDE specifications are in force, on which the certification is based on, unless it is withdrawn according to the VDE Testing and Certification Procedure (PM102E).*

*The validity period of a VDE-GS-Mark Approval may be prolonged on request. In case of changes in legal and / or normative requirements, the validity period of a VDE-GS-Mark Approval may be shortened.*

*Products containing the biocide dimethylfumarate (DMF) may not be marketed or made available on the EC market according to the Commission Decision 2009/251/EC.*

*The approval is solely signed on the first page.*

**Zertifikat**  
mit überwachter Konformität

**Certificate**  
of surveyed conformity



Zertifikat Nr. *Certificate No.*  
J 50457959

Blatt *Sheet*  
0001

Ihr Zeichen *Client Reference*

Unser Zeichen *Our Reference*

Ausstellungsdatum

*Date of Issue*

05-xieb-50314381 001

07.04.2020

(day/mo/yr)

**Genehmigungsinhaber *License Holder***

Dongguan Better Electronics  
Technology Co., Ltd.  
Room 601 of 16 Block, Xinzhu Yuan  
No 4, Xinzhu Road, Songshanlake  
Hightech Ind. Development Zone  
523808 Dongguan City Guangdong  
P.R. China

**Fertigungsstätte *Manufacturing Plant***

Dongguan Better Electronics  
Technology Co., Ltd.  
Nanmen Village, Hengkeng  
Administrative Zone, Liaobu Town  
Dongguan  
523413 Guangdong  
P.R. China

**Prüfzeichen *Test Mark***



**Geprüft nach *Tested acc. to***

EN 60127-1:2006+A1+A2 EN 60127-7:2016  
IEC 60127-1:2006+A1+A2 IEC 60127-7:2015

**Zertifiziertes Produkt (Geräteidentifikation)  
*Certified Product (Product Identification)***

**Lizenzentgelte - Einheit  
*License Fee - Unit***

**(Miniature Fuse-link)**

Type Designation : 513x 514x 515x 516x 517x 523x 525x 529x 15  
x = Blank or P  
Trademark : Better (Logo)  
T/I Characteristic : See appendix 1  
Rated Voltage : 1) AC 250V/300V, DC 420V/450V/500V  
2) & 3) AC 250V/300V/420V/450V/500V/600V  
DC 420V/450V/500V  
Rated Current : 1) 500mA, 630mA, 750mA, 800mA,  
1.25A, 2.5A  
2) 1A, 1.6A, 2A, 3.15A, 4A, 5A, 6.3A, 8A  
10A, 12A, 12.5A, 15A, 16A  
3) 20A, 25A

Continued on page 0002

15

Dem Zertifikat liegt unsere Prüf- und Zertifizierungsordnung zugrunde.  
Das Produkt entspricht den o.g. Anforderungen, die Herstellung wird überwacht.  
This certificate is based on our Testing and Certification Regulation. The product  
fulfills above mentioned requirements, the production is subject to surveillance.

**TÜV Rheinland LGA Products GmbH, Tillystraße 2, 90431 Nürnberg**

Tel.: +49 221 806-1371 e-mail: cert-validity@de.tuv.com  
Fax: +49 221 806-3935 http://www.tuv.com/safety



**Zertifikat**  
mit überwachter Konformität

**Certificate**  
of surveyed conformity



Zertifikat Nr. *Certificate No.*  
J 50457959

Blatt *Sheet*  
0002

Ihr Zeichen *Client Reference*

Unser Zeichen *Our Reference*  
05-xieb-50314381 001

Ausstellungsdatum *Date of Issue*  
07.04.2020 (day/mo/yr)

**Genehmigungsinhaber *License Holder***

Dongguan Better Electronics  
Technology Co., Ltd.  
Room 601 of 16 Block, Xinzhu Yuan  
No 4, Xinzhu Road, Songshan Lake  
Hightech Ind. Development Zone  
523808 Dongguan City Guangdong  
P.R. China

**Fertigungsstätte *Manufacturing Plant***

Dongguan Better Electronics  
Technology Co., Ltd.  
Nanmen Village, Hengkeng  
Administrative Zone, Liaobu Town  
Dongguan  
523413 Guangdong  
P.R. China

**Prüfzeichen *Test Mark***



**Geprüft nach *Tested acc. to***

EN 60127-1:2006+A1+A2 EN 60127-7:2016  
IEC 60127-1:2006+A1+A2 IEC 60127-7:2015

Zertifiziertes Produkt (Geräteidentifikation)  
*Certified Product (Product Identification)*

Lizenzentgelte - Einheit  
*License Fee - Unit*

(Miniature Fuse-link)

Continuation from page 0001

Rated Breaking Capacity: 1) 1500A or 750A at AC 250V/300V  
300A at DC 420V  
200A at DC 450V/500V  
2) 1500A or 750A at AC 250V/300V  
300A at AC 420V  
200A at AC 450V/500V/600V  
300A at DC 420V  
200A at DC 450V/500V  
3) 750A at AC 250V/300V  
300A at AC 420V  
200A at AC 450V/500V/600V  
300A at DC 420V  
200A at DC 450V/500V

Continued on page 0003

Dem Zertifikat liegt unsere Prüf- und Zertifizierungsordnung zugrunde.  
Das Produkt entspricht den o.g. Anforderungen, die Herstellung wird überwacht.  
This certificate is based on our Testing and Certification Regulation. The product  
fulfills above mentioned requirements, the production is subject to surveillance.

**TÜV Rheinland LGA Products GmbH, Tillystraße 2, 90431 Nürnberg**

Tel.: +49 221 806-1371 e-mail: cert-validity@de.tuv.com

Fax: +49 221 806-3935 http://www.tuv.com/safety



**Zertifikat**  
mit überwachter Konformität

**Certificate**  
of surveyed conformity



Zertifikat Nr. *Certificate No.*  
J 50457959

Blatt *Sheet*  
0003

<i>Ihr Zeichen Client Reference</i>	<i>Unser Zeichen Our Reference</i>	<i>Ausstellungsdatum Date of Issue</i>	<i>(day/mo/yr)</i>
	05-xieb-50314381 001	07.04.2020	

**Genehmigungsinhaber *License Holder***  
Dongguan Better Electronics  
Technology Co., Ltd.  
Room 601 of 16 Block, Xinzhu Yuan  
No 4, Xinzhu Road, Songshan Lake  
Hightech Ind. Development Zone  
523808 Dongguan City Guangdong  
P.R. China

**Fertigungsstätte *Manufacturing Plant***  
Dongguan Better Electronics  
Technology Co., Ltd.  
Nanmen Village, Hengkeng  
Administrative Zone, Liaobu Town  
Dongguan  
523413 Guangdong  
P.R. China

**Prüfzeichen *Test Mark***



**Geprüft nach *Tested acc. to***

EN 60127-1:2006+A1+A2 EN 60127-7:2016  
IEC 60127-1:2006+A1+A2 IEC 60127-7:2015

**Zertifiziertes Produkt (Geräteidentifikation)**  
*Certified Product (Product Identification)*

**Lizenzentgelte - Einheit**  
*License Fee - Unit*

(Miniature Fuse-link)

Continuation from page 0002

Dimension : 6.05mmx21.5mm (x = P)  
5.20mmx20mm (x = Blank)

**Remark:**

The labelling requirements acc. to EU Directive 2001/95 have to be observed for distribution within the EEA. The installation has to be carried out according to installation instruction accompanying the products.

ANLAGE (Appendix): 1

*Dem Zertifikat liegt unsere Prüf- und Zertifizierungsordnung zugrunde.  
Das Produkt entspricht den o.g. Anforderungen, die Herstellung wird überwacht.  
This certificate is based on our Testing and Certification Regulation. The product fulfills above mentioned requirements, the production is subject to surveillance.*

**TÜV Rheinland LGA Products GmbH, Tillystraße 2, 90431 Nürnberg**  
Tel.: +49 221 806-1371 e-mail: cert-validity@de.tuv.com  
Fax: +49 221 806-3935 http://www.tuv.com/safety

