

## 150mA Small Dual LDO Regulator with ON/OFF Switch

### GENERAL DESCRIPTION

The XC6420 series is a small dual CMOS LDO regulator with 2-channel 150mA outputs. The series features high speed, high accuracy, high ripple rejection and low dropout voltage. The series is capable of high density board installation by the small package of two low on-resistance regulators. Each output voltage is internally set in a range from 1.2V to 3.6V in increments of 0.05V with  $\pm 2\%$  accuracy.

The EN function controls the two regulators on/off independently. In the stand-by mode, the electric charge at the output capacitor  $C_L$  is discharged via the internal switch and as a result the  $V_{OUT}$  pin quickly returns to the  $V_{SS}$  level.

The series is also compatible with low ESR ceramic capacitors. The high level of output stability is maintained even during frequent load fluctuations, due to the excellent transient response performance. The two regulators are completely isolated so that a cross talk during load fluctuations is minimized.

### APPLICATIONS

- Smart phones / Mobile phones
- Portable game consoles
- Digital audio equipments
- Digital still cameras / Camcorders

### FEATURES

Maximum Output Current	: 150mA
Operating Voltage Range	: 1.6V ~ 5.5V
Output Voltage	: 1.2V ~ 3.6V ( $\pm 2\%$ ) 0.05V increments
Dropout Voltage	: 190mV @ $I_{OUT}=150mA$ ( $V_{OUT}=3.3V$ )
Low Power Consumption	: 55 $\mu A$ / ch (TYP.)
Stand-by Current	: 0.1 $\mu A$
Ripple Rejection	: 75dB@1kHz
EN Function	: Active High
	$C_L$ High Speed Auto Discharge
Protection Circuit	: Current Limit 250mA (TYP.) Short Circuit 50mA (TYP.)
Output Capacitor	: 1.0 $\mu F$ Ceramic Capacitor
Operating Ambient Temperature	: -40 ~ +85
Packages	: SOT-26 USPN-6 USP-6B04
Environmentally Friendly	: EU RoHS Compliant, Pb Free

### TYPICAL APPLICATION CIRCUITS

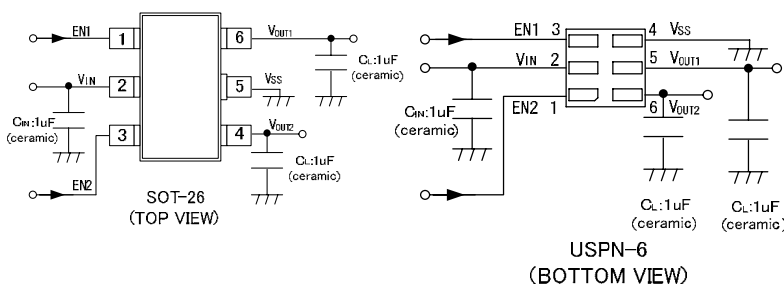
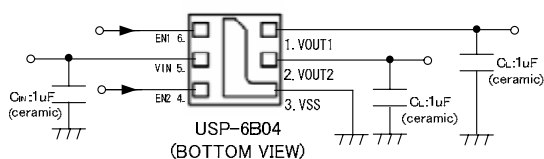

### TYPICAL PERFORMANCE CHARACTERISTICS

#### Ripple Rejection

XC6420 ( $V_{OUT}=1.8V$ )  
 $V_{IN}=3.0V+0.5V_{pp}$ ,  $T_a=25$   
 $C_{IN}=0.1 \mu F$  (ceramic),  $C_L=1.0 \mu F$  (ceramic)

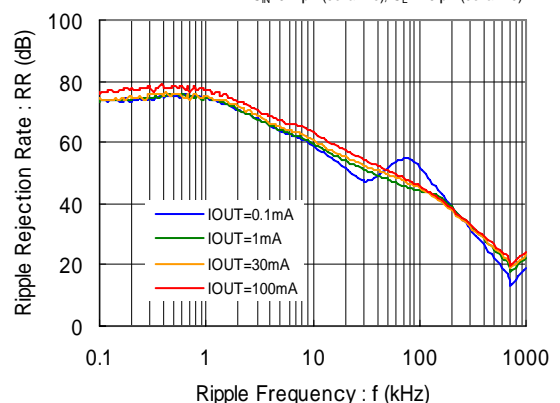

## PIN CONFIGURATION

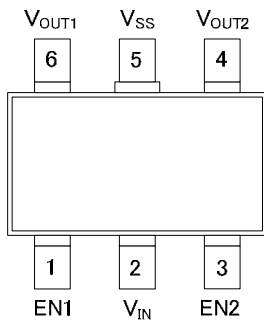

SOT-26  
(TOP VIEW)

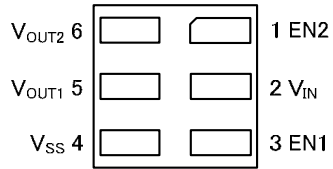

USPN-6  
(BOTTOM VIEW)

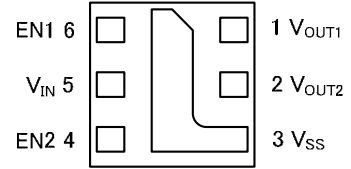

USP-6B04  
(BOTTOM VIEW)

## PIN ASSIGNMENT

PIN NUMBER			PIN NAME	FUNCTIONS
SOT-26	USPN-6	USP-6B04		
1	3	6	EN1	ON/OFF Control 1
2	2	5	V <sub>IN</sub>	Power Input
3	1	4	EN2	ON/OFF Control 2
4	6	2	V <sub>OUT2</sub>	Output 2
5	4	3	V <sub>SS</sub>	Ground
6	5	1	V <sub>OUT1</sub>	Output 1

## PRODUCT CLASSIFICATION

### Ordering Information

XC6420 - <sup>(\*)</sup>

DESIGNATOR	ITEM	SYMBOL	DESCRIPTION
	Basic Function	A	EN1: Active High, EN2: Active High V <sub>OUT1</sub> : with C <sub>L</sub> Auto Discharge, V <sub>OUT2</sub> : with C <sub>L</sub> Auto Discharge
	Enable Pin	B	EN1: With Pull-down, With EN2: Pull-down
	Output Voltage	01 ~	See the chart below
- <sup>(*)</sup>	Packages (Order Unit)	MR-G	SOT-26 (3,000/Reel)
		7R-G	USPN-6 (5,000/Reel)
		DR-G	USP-6B04 (5,000/ Reel)

<sup>(\*)</sup> The "-G" suffix denotes Halogen and Antimony free as well as being fully EU RoHS compliant.

### DESIGNATOR

	V <sub>OUT1</sub> (V)	V <sub>OUT2</sub> (V)		V <sub>OUT1</sub> (V)	V <sub>OUT2</sub> (V)
01	1.20	1.20	31	1.50	2.80
02	1.20	1.50	32	1.80	2.80
03	1.20	2.50	33	2.80	2.80
04	1.20	2.85	34	2.80	3.00
05	1.20	3.00	35	2.80	3.30
06	1.20	3.30	36	1.20	3.60
07	1.50	1.50	37	3.60	1.20
08	1.50	1.80	38	1.20	2.80
09	1.50	2.50	39	3.30	2.00
10	1.50	2.85	40	3.00	3.30
11	1.50	3.00	41	3.30	3.30
12	1.50	3.30	42	1.30	1.50
13	1.80	1.80	43	2.60	2.80
14	1.80	2.50	44	3.10	3.30
15	2.85	2.85	45	1.50	2.60
16	1.80	2.85	46	2.60	3.30
17	1.80	3.00	47	3.40	3.40
18	3.00	1.80	48	2.85	2.60
19	1.80	3.30	49	3.30	1.80
20	2.50	2.50	50	1.80	1.20
21	2.50	2.80	51	3.10	3.10
22	2.50	2.85	52	1.50	3.10
23	3.30	1.50	53	3.30	2.80
24	2.50	3.00	54	3.00	2.80
25	2.50	3.30	55	3.30	3.00
26	2.85	3.00			
27	2.85	3.30			
28	3.00	3.00			
29	1.20	1.80			
30	1.30	2.80			

\*For other output voltage combinations, please contact your local Torex sales office or representative.

## BLOCK DIAGRAMS

XC6420ABxxxxseries

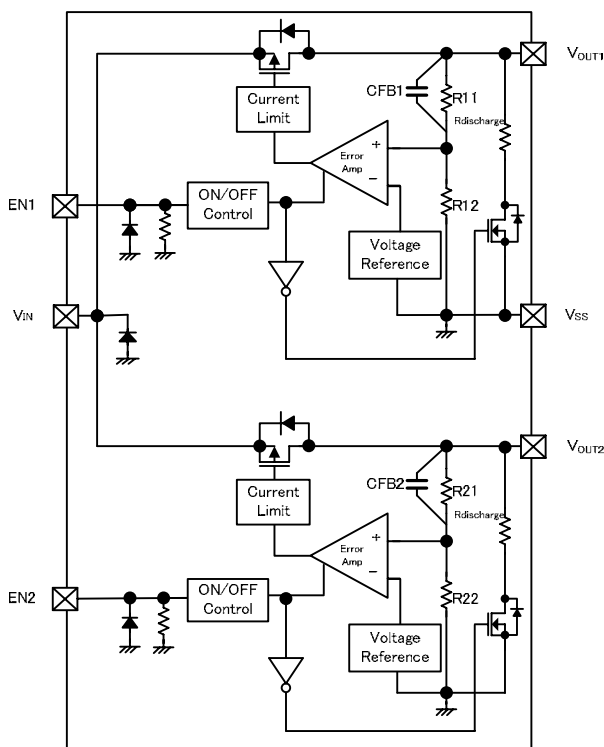

\* Diodes inside the circuits are ESD protection diodes and parasitic diodes.

## ABSOLUTE MAXIMUM RATINGS

PARAMETER	SYMBOL	RATINGS	UNITS
Input Voltage	$V_{IN}$	$V_{SS}-0.3 \sim +7.0$	V
Output Current	$I_{OUT1}+I_{OUT2}$	600 <sup>(*)</sup>	mA
Output Voltage 1 / Output Voltage2	$V_{OUT1} / V_{OUT2}$	$V_{SS}-0.3 \sim V_{IN}+0.3$	V
EN1/EN2 Input Voltage	$V_{EN1} / V_{EN2}$	$V_{SS}-0.3 \sim +7.0$	V
Power Dissipation	Pd	250	mW
		600 (PCB mounted) <sup>(**)</sup>	
		100	
		600 (PCB mounted) <sup>(**)</sup>	
Operating Ambient Temperature	$T_{opr}$	-40 ~ +85	
Storage Temperature	$T_{stg}$	-55 ~ +125	

<sup>(\*)</sup> Please use within the range of  $P_d > \{ (V_{IN}-V_{OUT1}) \times I_{OUT1} + (V_{IN}-V_{OUT2}) \times I_{OUT2} \}$

<sup>(\*\*)</sup> This is a reference data taken by using the test board. Please refer to 22 ~ 24 for detail information of test condition.

## ELECTRICAL CHARACTERISTICS

XC6420 series

Regulator 1, Regulator 2 <sup>(\*8)</sup>

Ta=25

PARAMETER	SYMBOL	CONDITIONS	MIN.	TYP.	MAX.	UNITS	CIRCUITS
Output Voltage	V <sub>OUT(E)</sub> <sup>(*2)</sup>	V <sub>EN</sub> = V <sub>IN</sub> , I <sub>OUT</sub> = 10mA	V <sub>OUT(T)</sub> ×0.98 <sup>(*3)</sup>	V <sub>OUT(T)</sub> <sup>(*4)</sup>	V <sub>OUT(T)</sub> ×1.02 <sup>(*3)</sup>	V	
Maximum Output Current	I <sub>OUTMAX</sub>	V <sub>EN</sub> = V <sub>IN</sub>	150	-	-	mA	
Load Regulation	ΔV <sub>OUT</sub>	V <sub>EN</sub> = V <sub>IN</sub> 0.1mA I <sub>OUT</sub> 150mA	-	25	45	mV	
Dropout Voltage <sup>(*5)</sup>	V <sub>dif</sub>	I <sub>OUT</sub> = 150mA, V <sub>EN</sub> = V <sub>IN</sub>	See "OUTPUT VOLTAGE CHART"			mV	
Supply Current	I <sub>SS</sub>	V <sub>EN</sub> = V <sub>IN</sub> I <sub>OUT</sub> = 0mA	-	55	105	μA	
Stand-by Current	I <sub>STB</sub>	V <sub>EN</sub> = V <sub>SS</sub>	-	0.01	0.1	μA	
Line Regulation	ΔV <sub>OUT</sub> / (ΔV <sub>IN</sub> · V <sub>OUT</sub> )	2.5V V <sub>IN</sub> 5.0V (V <sub>OUT(T)</sub> 2.0V) V <sub>EN</sub> = V <sub>IN</sub> , I <sub>OUT</sub> = 30mA V <sub>OUT(T)</sub> + 0.5V V <sub>IN</sub> 5.5V (V <sub>OUT(T)</sub> 2.05V) V <sub>EN</sub> = V <sub>IN</sub> , I <sub>OUT</sub> = 30mA	-	0.02	0.1	%/V	
Input Voltage	V <sub>IN</sub>	-	1.6	-	5.5	V	
Output Voltage Temperature Characteristics (R&D Value)	ΔV <sub>OUT</sub> / (ΔT <sub>opr</sub> · V <sub>OUT</sub> )	V <sub>EN</sub> = V <sub>IN</sub> , I <sub>OUT</sub> = 10mA -40 Ta 85	-	±100	-	ppm /	
Power Supply Rejection Ratio	PSRR	V <sub>EN</sub> = V <sub>IN</sub> V <sub>IN</sub> {V <sub>OUT(T)</sub> +1.0}+0.5Vp-pAC I <sub>OUT</sub> = 30mA, f=1kHz	-	75	-	dB	
Limit Current	I <sub>LIM</sub>	V <sub>EN</sub> = V <sub>IN</sub>	150	250	-	mA	
Short Current	I <sub>SHORT</sub>	V <sub>EN</sub> = V <sub>IN</sub> V <sub>OUT</sub> = V <sub>SS</sub>	-	50	-	mA	
EN <sup>"H"</sup> Level Voltage	V <sub>ENH</sub>	-	1.0	-	5.5	V	
EN <sup>"L"</sup> Level Voltage	V <sub>ENL</sub>	-	-	-	0.3	V	
EN <sup>"H"</sup> Level Current	I <sub>ENH</sub>	V <sub>EN</sub> = V <sub>IN</sub> = 5.5V	2.5	6.0	9.1	μA	
EN <sup>"L"</sup> Level Current	I <sub>ENL</sub>	V <sub>EN</sub> = V <sub>SS</sub>	-0.1	-	0.1	μA	
C <sub>L</sub> Discharge Resistor	R <sub>DCHG</sub>	V <sub>IN</sub> = 5.5V, V <sub>EN</sub> = V <sub>SS</sub> V <sub>OUT</sub> = 2.0V	-	300	-	Ω	

**NOTE:**

Unless otherwise stated, V<sub>IN</sub> = V<sub>OUT(T)</sub> + 1V, I<sub>OUT</sub> = 1mA, C<sub>IN</sub> = C<sub>L</sub> = 1.0 μF.

(\*1) V<sub>OUT(E)</sub>: Effective output voltage

(\*2) Characteristics of the actual V<sub>OUT(E)</sub> by setting output voltage is shown in the voltage chart.

(\*3) V<sub>OUT(T)</sub>: Nominal output voltage

(\*4) V<sub>dif</sub> = {V<sub>IN1</sub> - V<sub>OUT1</sub>}

V<sub>IN1</sub>: The input voltage when V<sub>OUT1</sub> appears as input voltage is gradually decreased.

V<sub>OUT1</sub>: A voltage equal to 98% of the output voltage whenever an amply stabilized I<sub>OUT</sub>{V<sub>OUT(T)</sub>+1.0V} is input.

(\*5) E-1: See the dropout voltage chart

(\*6) Each channel is measured when the other channel is turned off (V<sub>EN</sub> = V<sub>SS</sub>).

## OUTPUT VOLTAGE CHART

NOMINAL OUTPUT VOLTAGE (V)	OUTPUT VOLTAGE (V)		DROPOUT VOLTAGE (mV)	
	$V_{OUT(E)}$		$V_{dif}$	
	MIN.	MAX.	TYP.	MAX.
1.200	1.176	1.224	560	710
1.250	1.225	1.275		
1.300	1.274	1.326	530	600
1.350	1.323	1.377		
1.400	1.372	1.428	460	520
1.450	1.421	1.479		
1.500	1.470	1.530		
1.550	1.519	1.581		
1.600	1.568	1.632	380	470
1.650	1.617	1.683		
1.700	1.666	1.734		
1.750	1.715	1.785		
1.800	1.764	1.836	300	450
1.850	1.813	1.887		
1.900	1.862	1.938		
1.950	1.911	1.989		
2.000	1.960	2.040	280	390
2.050	2.009	2.091		
2.100	2.058	2.142		
2.150	2.107	2.193		
2.200	2.156	2.244		
2.250	2.205	2.295		
2.300	2.254	2.346		
2.350	2.303	2.397		
2.400	2.352	2.448		

NOMINAL OUTPUT VOLTAGE (V)	OUTPUT VOLTAGE (V)		DROPOUT VOLTAGE (mV)	
	$V_{OUT(E)}$		$V_{dif}$	
	MIN.	MAX.	TYP.	MAX.
2.450	2.401	2.499	280	390
2.500	2.450	2.550	200	340
2.550	2.499	2.601		
2.600	2.548	2.652		
2.650	2.597	2.703		
2.700	2.646	2.754		
2.750	2.695	2.805		
2.800	2.744	2.856		
2.850	2.793	2.907		
2.900	2.842	2.958		
2.950	2.891	3.009		
3.000	2.940	3.060	190	270
3.050	2.989	3.111		
3.100	3.038	3.162		
3.150	3.087	3.213		
3.200	3.136	3.264		
3.250	3.185	3.315		
3.300	3.234	3.366		
3.350	3.283	3.417		
3.400	3.332	3.468		
3.450	3.381	3.519		
3.500	3.430	3.570		
3.550	3.479	3.621		
3.600	3.528	3.672		

## OPERATIONAL EXPLANATION

The voltage divided by resistors Rx1 & Rx2 is compared with the internal reference voltage by the error amplifier. The P-channel MOSFET connected to the V<sub>OUT</sub> pin is then driven by the subsequent output signal. The output voltage at the V<sub>OUT</sub> pin is controlled & stabilized by a system of negative feedback. The current limit circuit and short protect circuit operate in relation to the level of output current. Further, the IC's internal circuitry can be shutdown via the EN pin's signal.

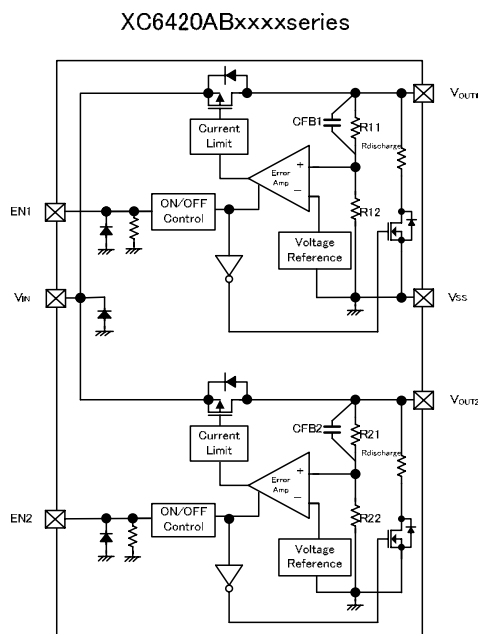

### <Low ESR Capacitor>

The XC6420 needs an output capacitor (C<sub>L</sub>) for phase compensation. In order to ensure the effectiveness of the phase compensation, we suggest that an output capacitor (C<sub>L</sub>) is connected as close as possible to the output pin (V<sub>OUT</sub>) and the V<sub>SS</sub> pin. Please use an output capacitor with a capacitance value of at least 1.0 μF. Also, please place 1.0 μF input capacitor C<sub>L</sub> between V<sub>IN</sub> and V<sub>SS</sub> pins for stabilizing input supply voltage.

### <Current Limiter, Short-Circuit Protection>

The XC6420 includes a combination of a fixed current limiter circuit & a foldback circuit, which aid the operations of the current limiter and circuit protection. When the load current reaches the current limit level, the fixed current limiter circuit operates and output voltage drops. As a result of this drop in output voltage, the foldback circuit operates, output voltage drops further and output current decreases. When the output pin is shorted, a current of about 50mA flows.

### <EN Pin>

The IC's internal circuitry can be shutdown via the signal from the EN pin with the XC6420 series. In shutdown mode, the series enables the electric charge at the output capacitor C<sub>L</sub> to be discharged via the internal switch between V<sub>OUT</sub> pin and V<sub>SS</sub> pin, and as a result the V<sub>OUT</sub> pin quickly returns to the V<sub>SS</sub> level.

The EN pin is internally pulled down by a resistor. Please note that input current through a pull-down resistor exists.

### <C<sub>L</sub> Auto-Discharge Function>

XC6420 series can quickly discharge the electric charge at the output capacitor (C<sub>L</sub>), when a low signal to the EN pin, which enables a whole IC circuit put into OFF state, is inputted via the N-channel transistor located between the V<sub>OUT</sub> pin and the V<sub>SS</sub> pin (cf. BLOCK DIAGRAM). The C<sub>L</sub> discharge resistance is set to 300 Ω when V<sub>IN</sub> is 5.5V (TYP.) and V<sub>OUT</sub> is 2.0V (TYP.). Moreover, discharge time of the output capacitor (C<sub>L</sub>) is set by the C<sub>L</sub> auto-discharge resistance and the output capacitor (C<sub>L</sub>). By setting time constant of a C<sub>L</sub> auto-discharge resistance value [R<sub>DCHG</sub>] and an output capacitor value (C<sub>L</sub>) as τ = C × R, the output voltage after discharge via the N channel transistor is calculated by the following formulas.

$$V = V_{OUT(E)} \times e^{-t/\tau}, \text{ or } t = \tau \ln(V_{OUT(E)} / V)$$

V : Output voltage after discharge, V<sub>OUT(E)</sub> : Output voltage, t: Discharge time,  
τ : C<sub>L</sub> auto-discharge resistance R<sub>DCHG</sub> × Output capacitor (C<sub>L</sub>) value C

## NOTES ON USE

1. For temporary, transitional voltage drop or voltage rising phenomenon, the IC is liable to malfunction should the ratings be exceeded.
2. Torex places an importance on improving our products and its reliability.  
However, by any possibility, we would request user fail-safe design and post-aging treatment on system or equipment.
3. Where wiring impedance is high, operations may become unstable due to the noise and/or phase lag depending on output current. Please strengthen  $V_{IN}$  and  $V_{SS}$  wiring in particular.
4. Please wire the input capacitor ( $C_{IN}$ ) and the output capacitor ( $C_L$ ) as short and close to the IC as possible.



## TEST CIRCUITS

Circuit

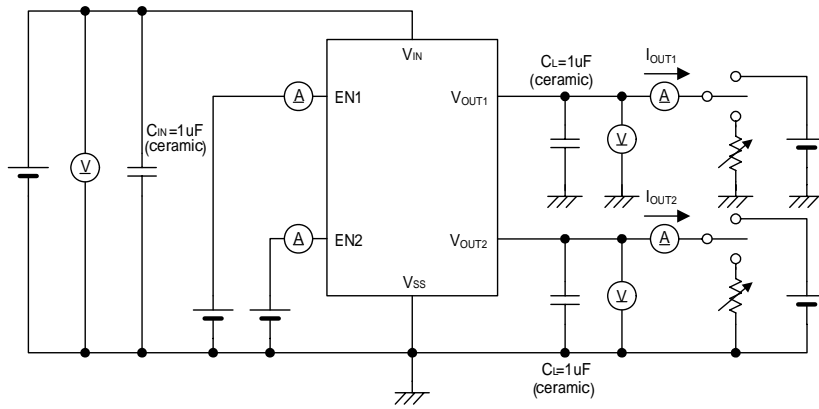

Circuit

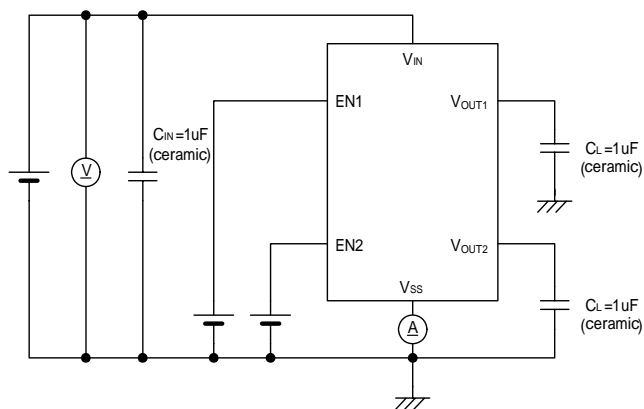

Circuit

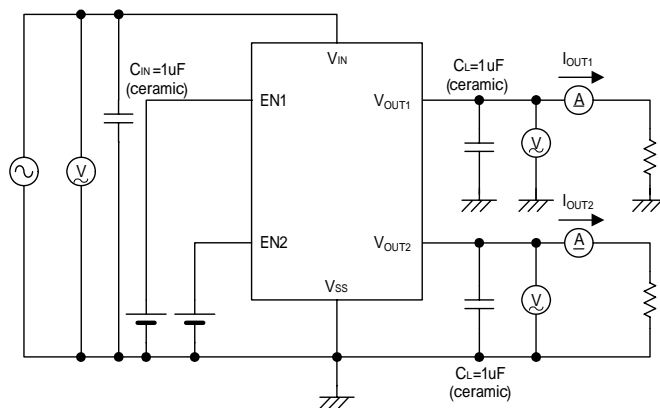

## TYPICAL PERFORMANCE CHARACTERISTICS

\* EN Voltage condition: Unless otherwise stated,  $V_{EN}=V_{IN}$ .

### (1) Output Voltage vs. Output Current

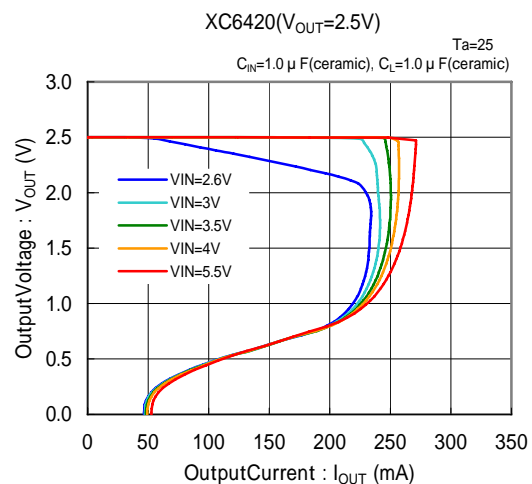
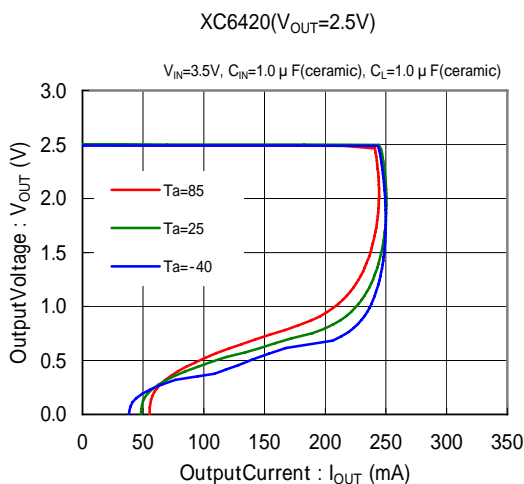
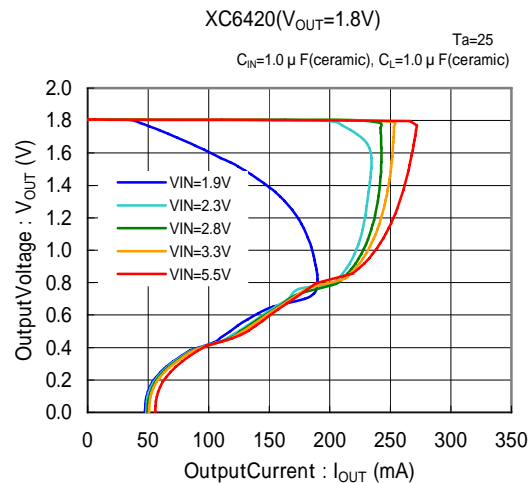
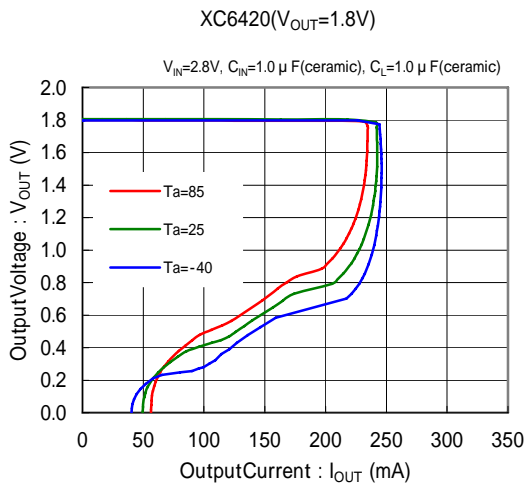
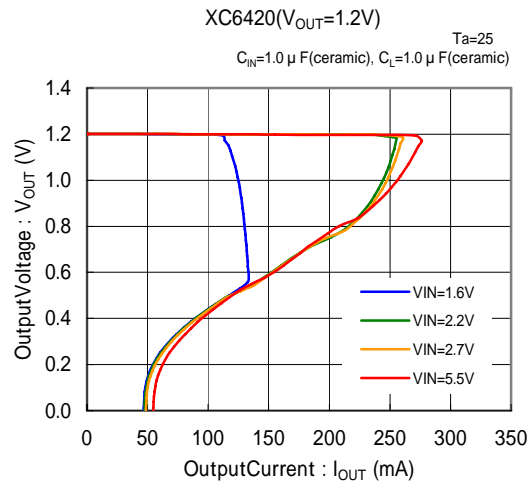
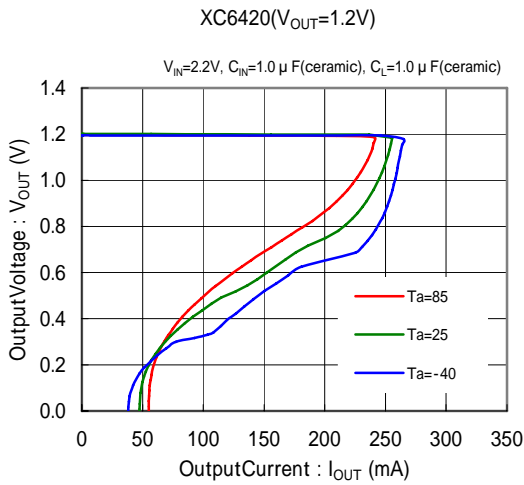

## TYPICAL PERFORMANCE CHARACTERISTICS (Continued)

### (1) OutputVoltage vs. OutputCurrent

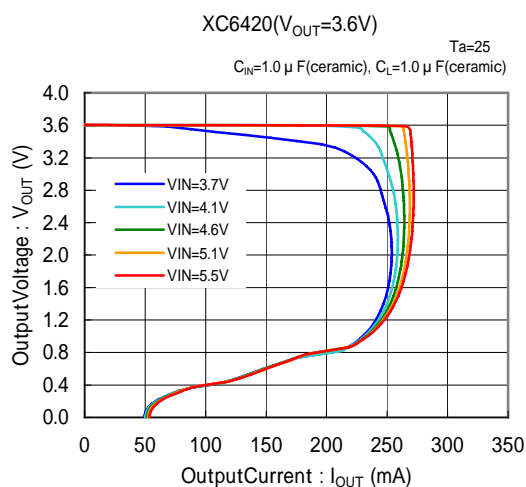
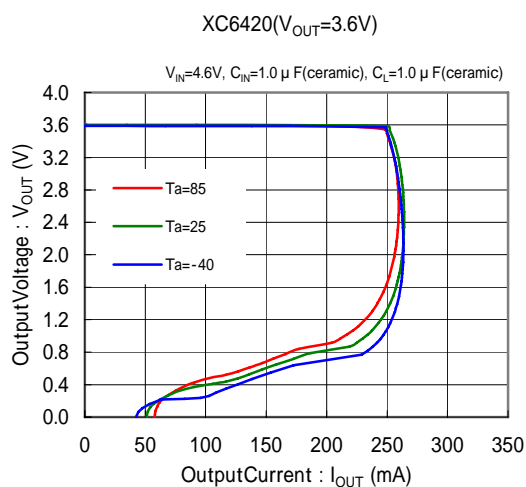

### (2) OutputVoltage vs. InputVoltage

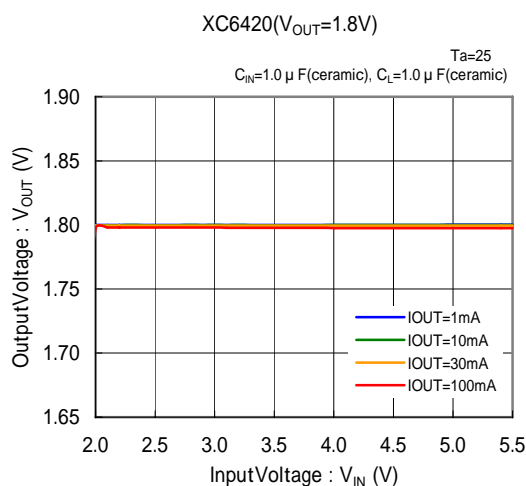
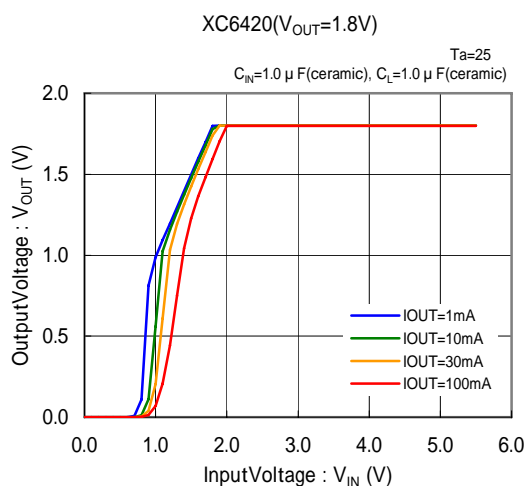
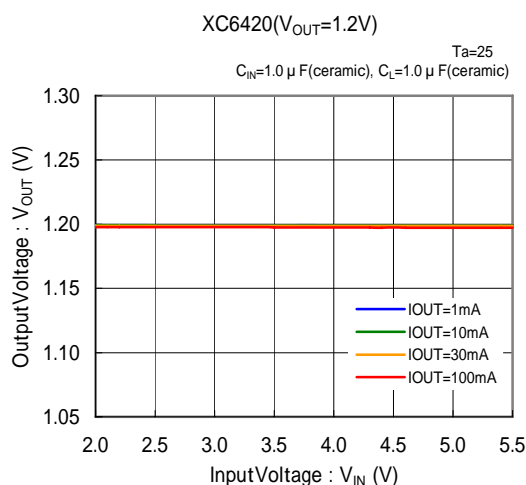
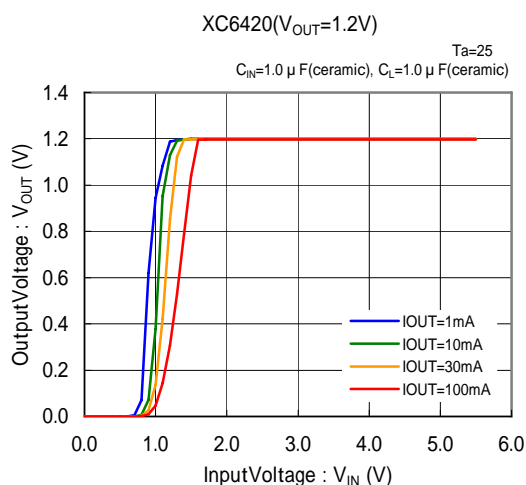

## TYPICAL PERFORMANCE CHARACTERISTICS (Continued)

### (2) OutputVoltage vs. InputVoltage

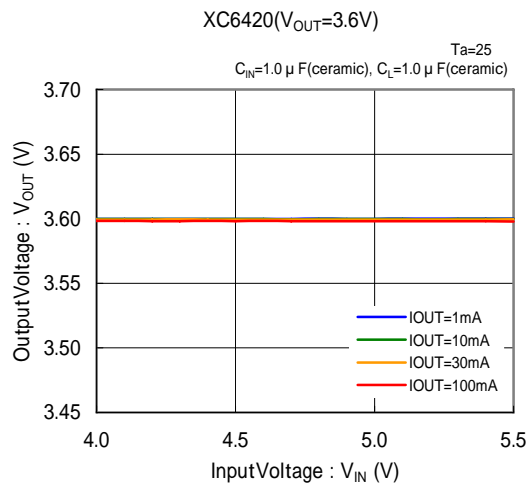
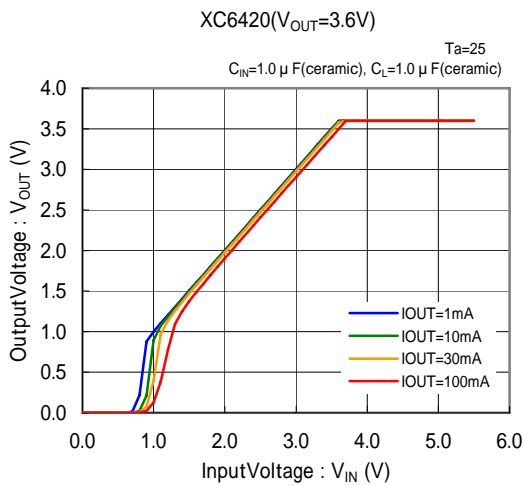
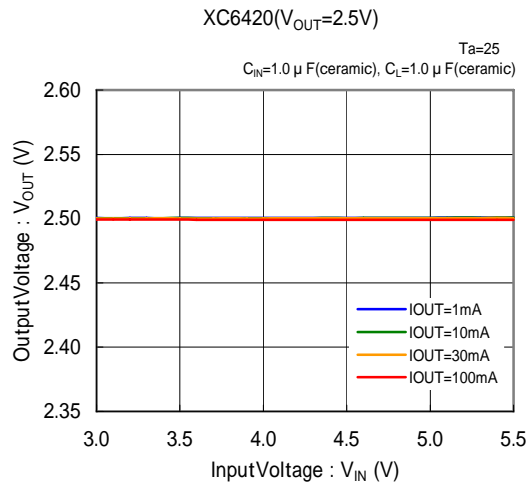
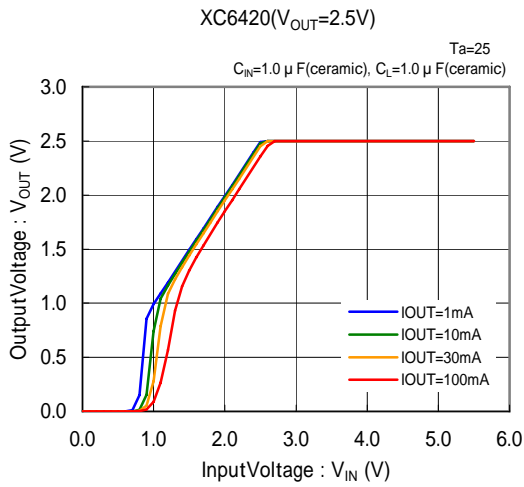

### (3) DropoutVoltage vs. OutputCurrent

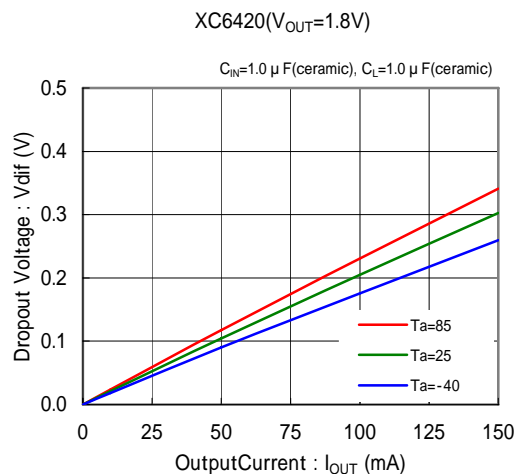
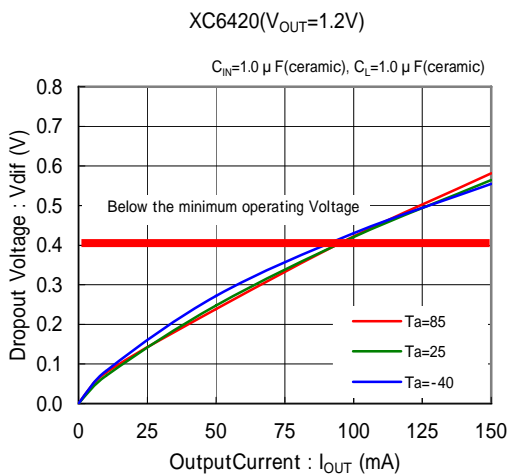

## TYPICAL PERFORMANCE CHARACTERISTICS (Continued)

### (3) Dropout Voltage vs. Output Current

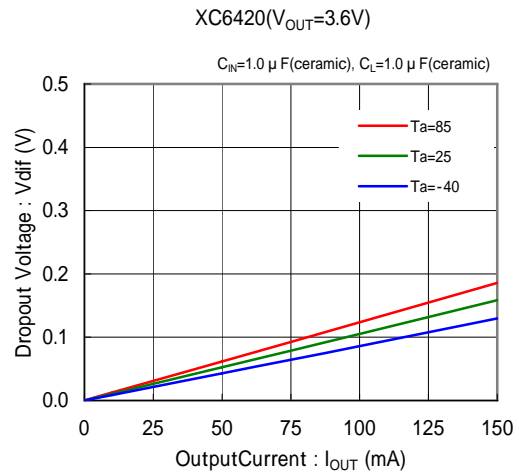
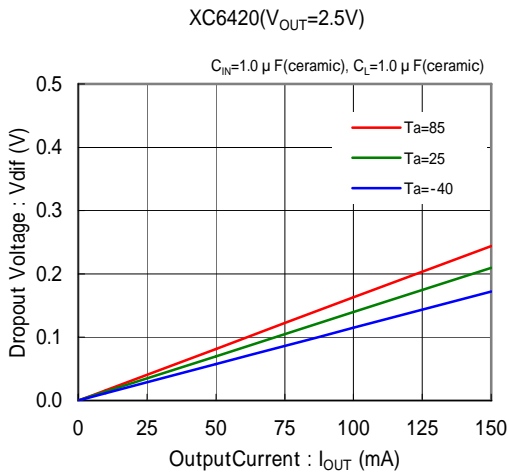

### (4) Supply Current vs. Input Voltage

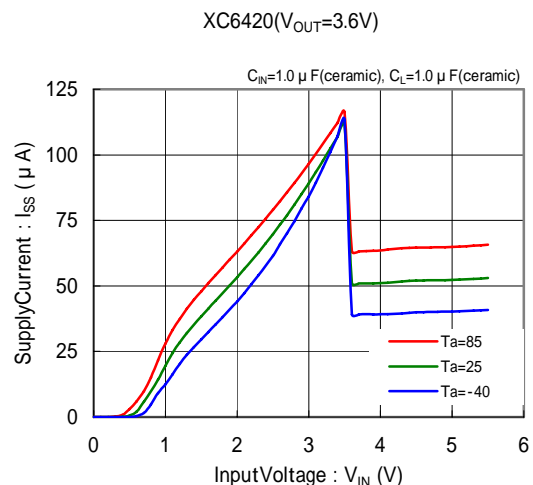
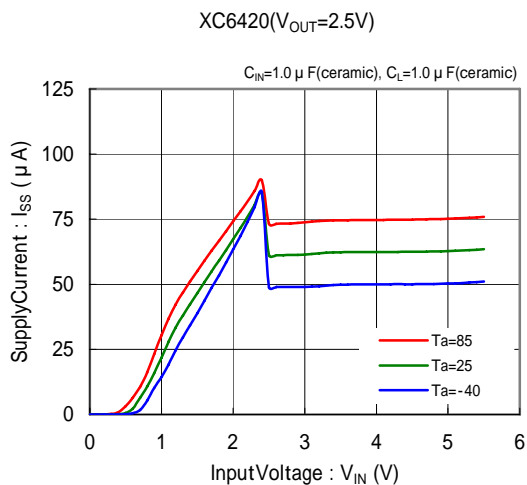
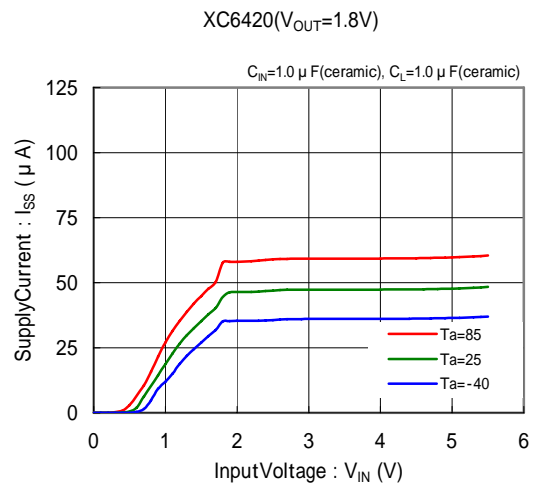
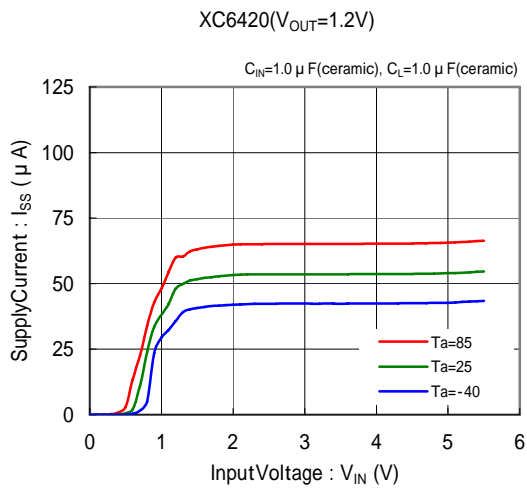

## TYPICAL PERFORMANCE CHARACTERISTICS (Continued)

### (5) Output Voltage vs. Ambient Temperature

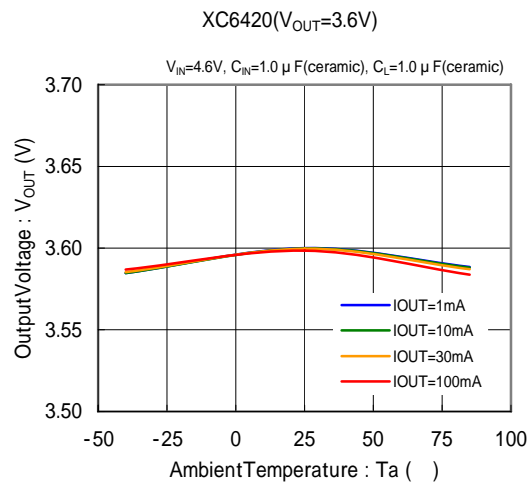
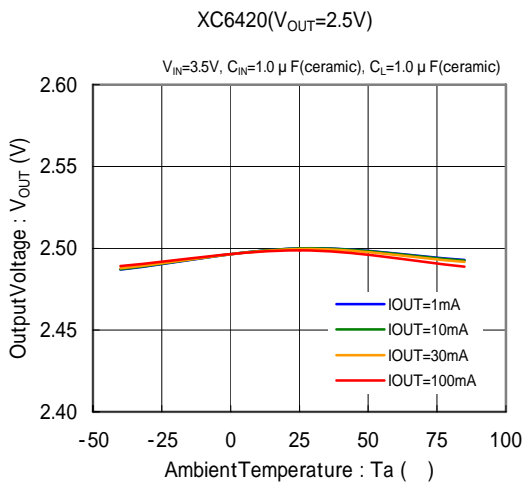
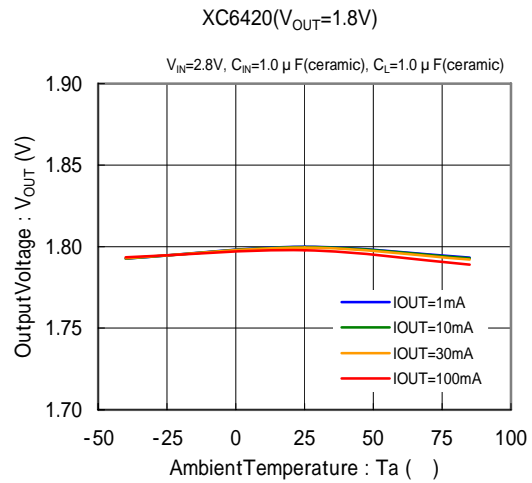
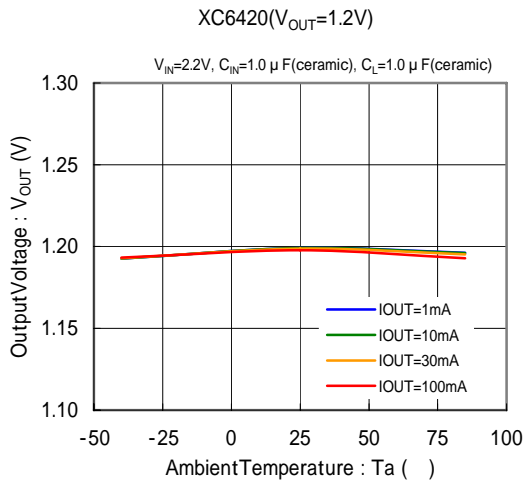

### (6) Supply Current vs. Ambient Temperature

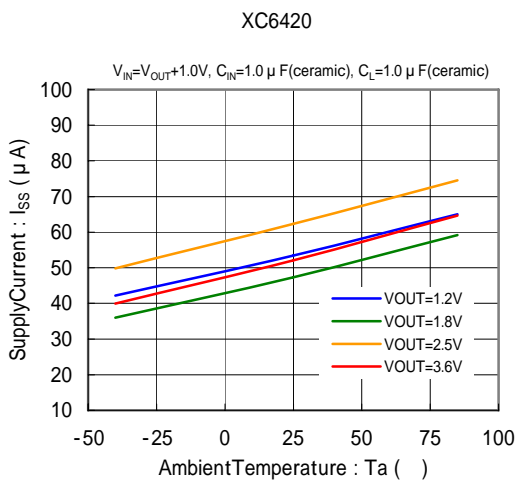

### (7) EN Threshold Voltage vs. Ambient Temperature

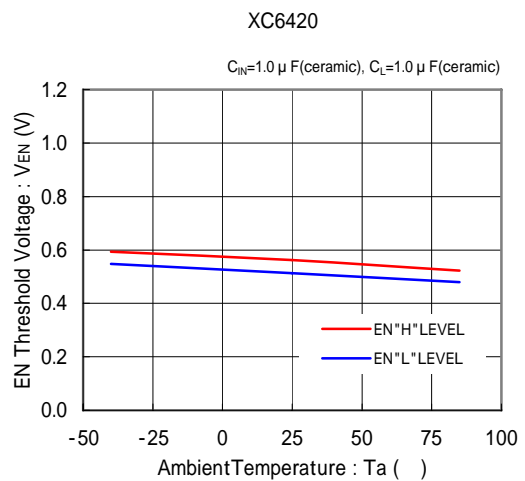

## TYPICAL PERFORMANCE CHARACTERISTICS (Continued)

### (8) Rising Response Time

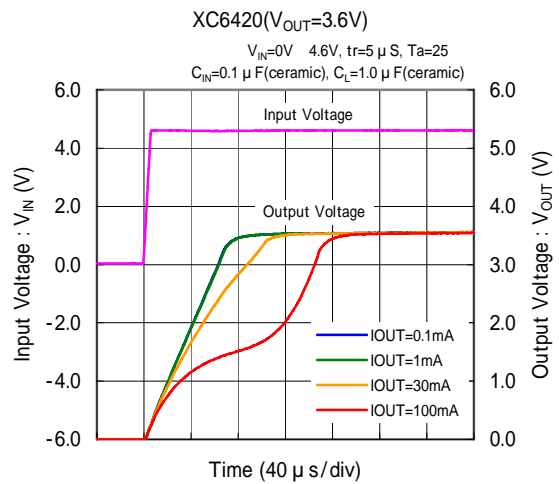
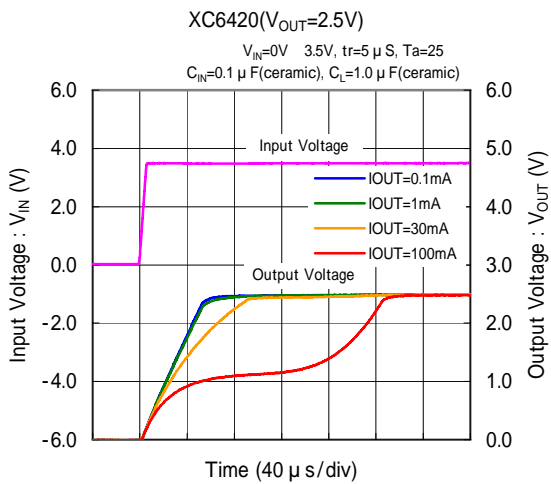
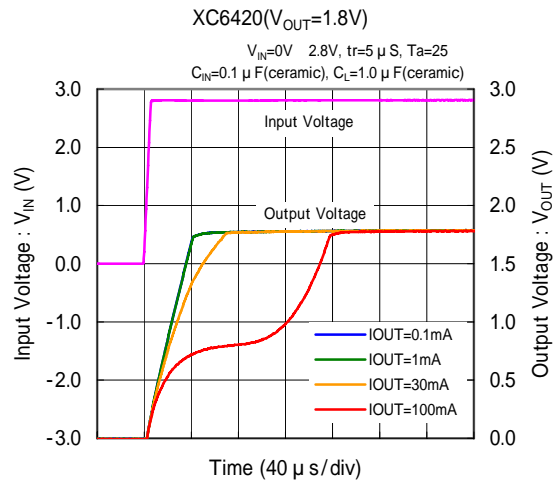
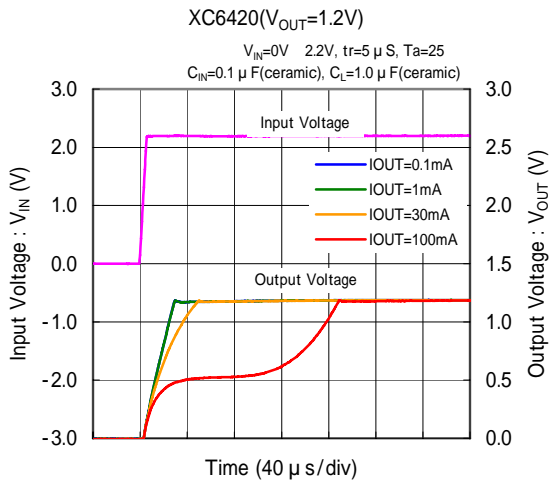

### (9) Input Transient Response

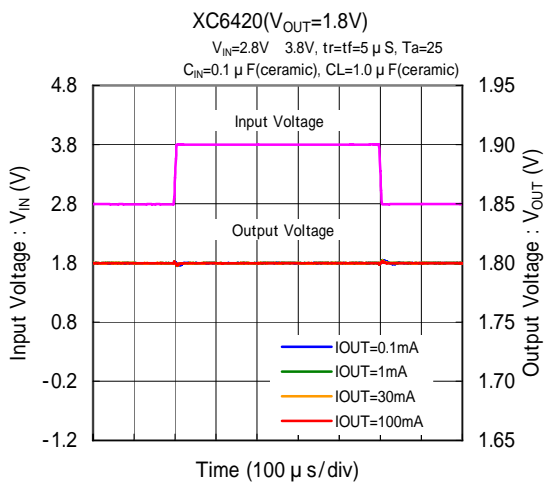
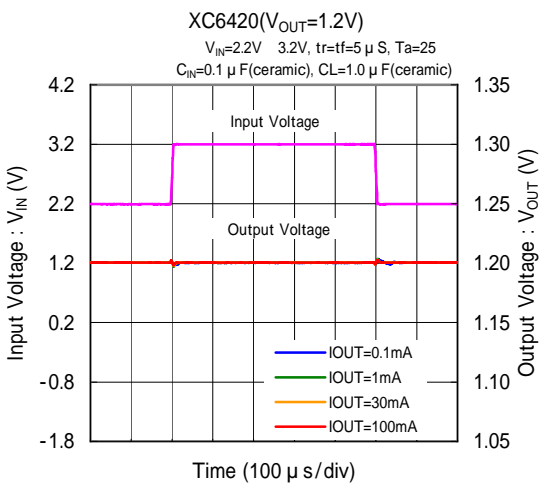

## TYPICAL PERFORMANCE CHARACTERISTICS (Continued)

### (9) Input Transient Response

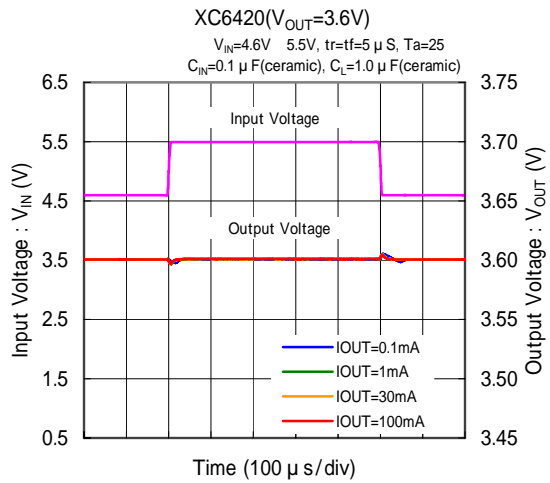
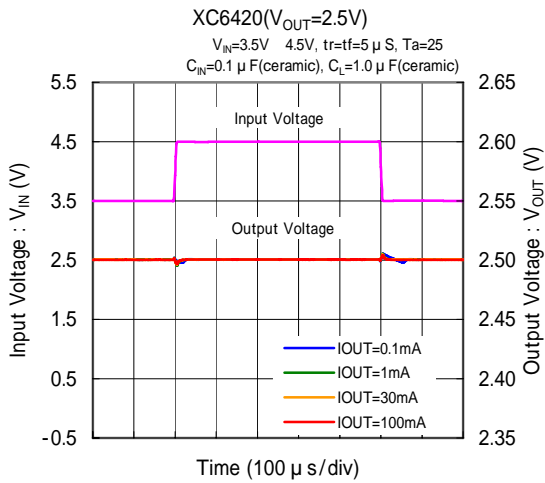

### (10) Load Transient Response

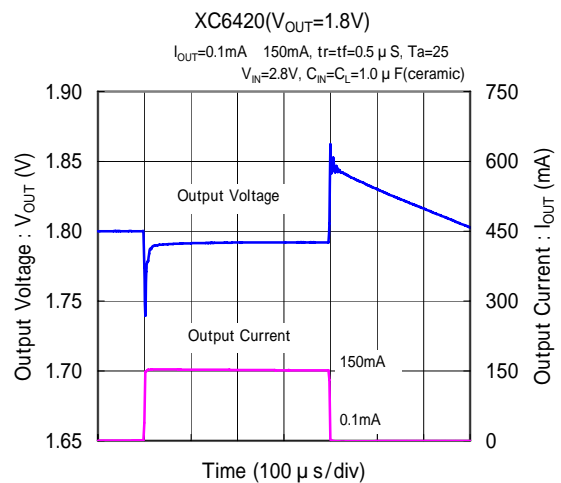
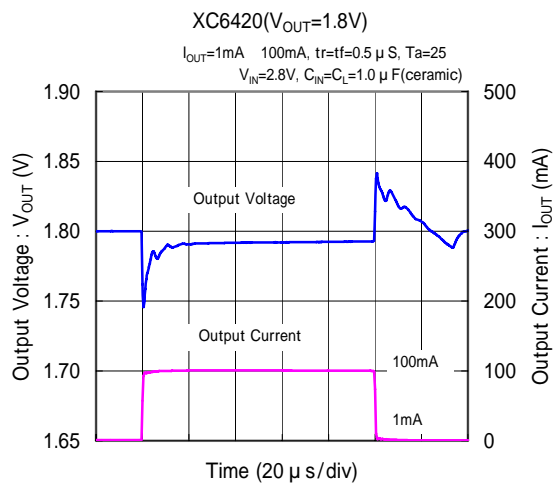
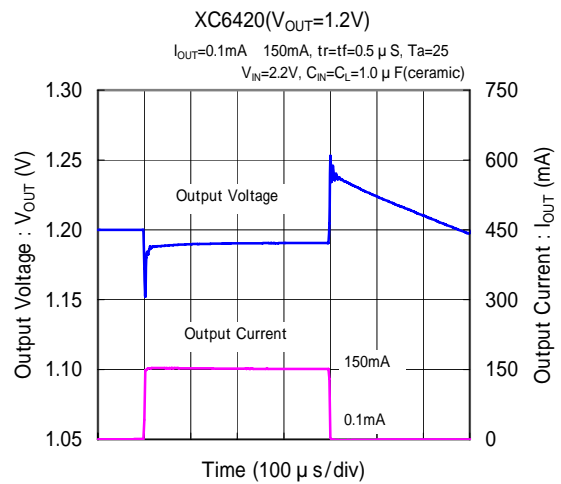
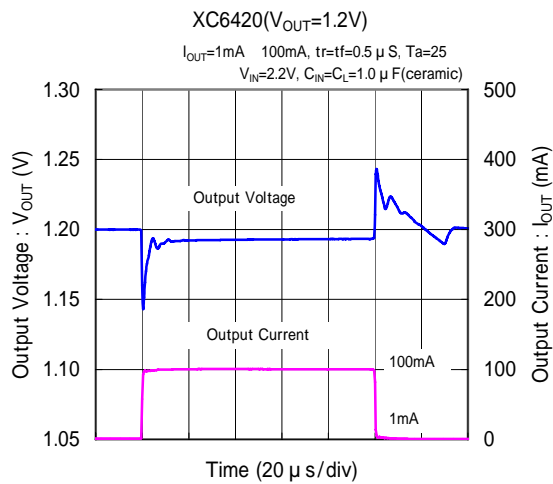



## TYPICAL PERFORMANCE CHARACTERISTICS (Continued)

### (10) Load Transient Response

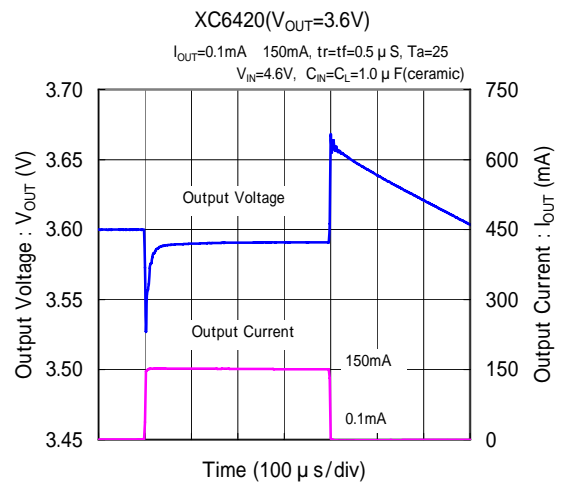
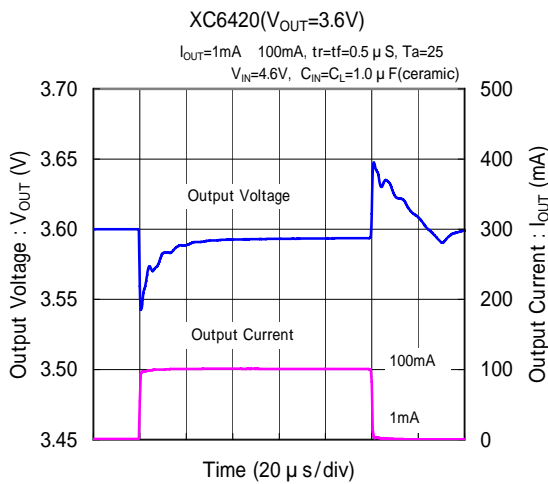
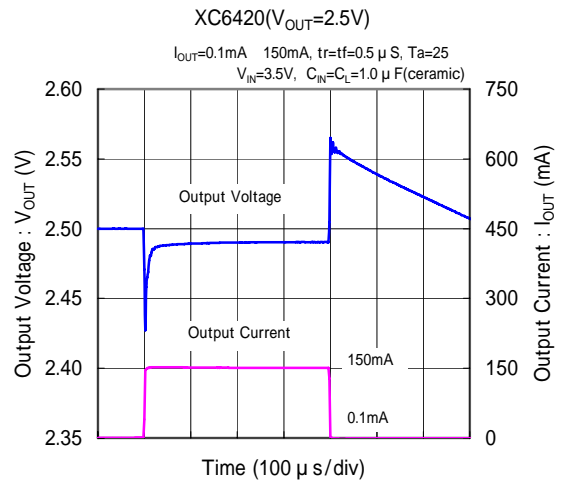
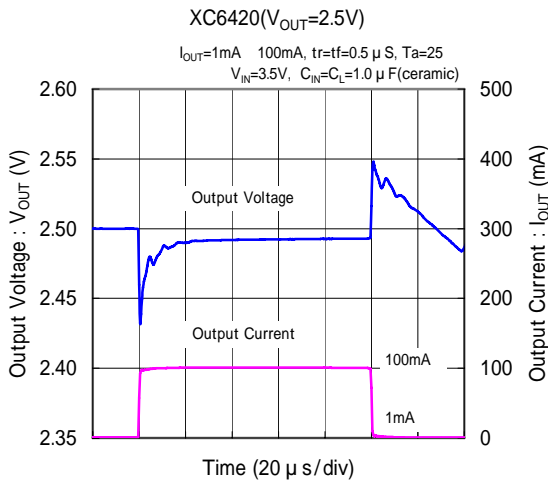

### (11) EN Rising Respose Time

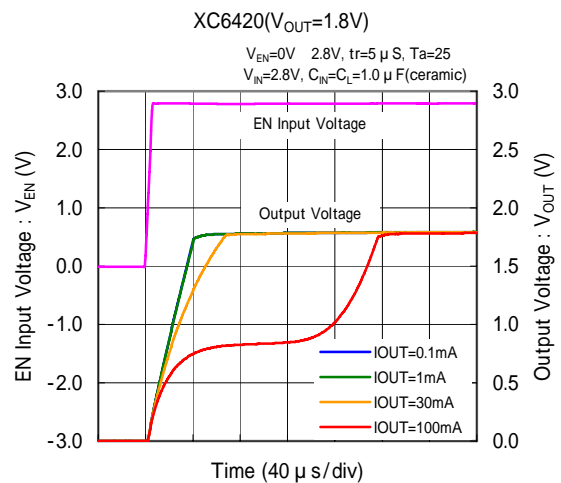
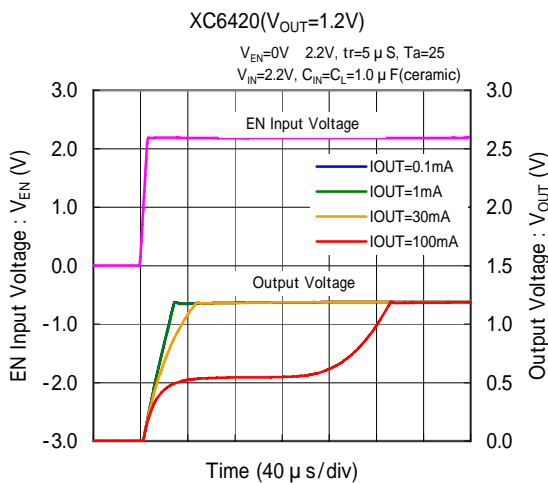

## TYPICAL PERFORMANCE CHARACTERISTICS (Continued)

### (11) EN Rising Respose Time

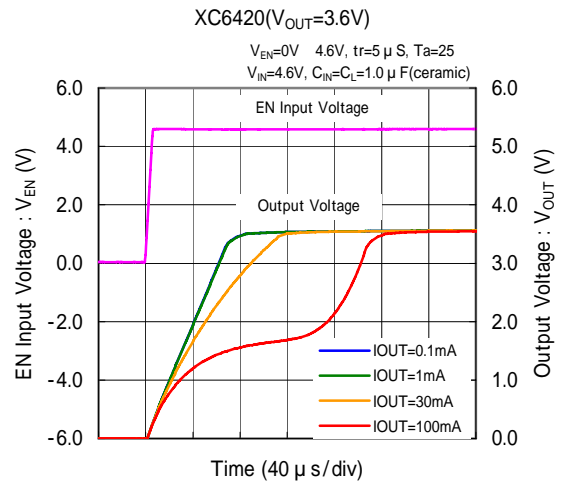
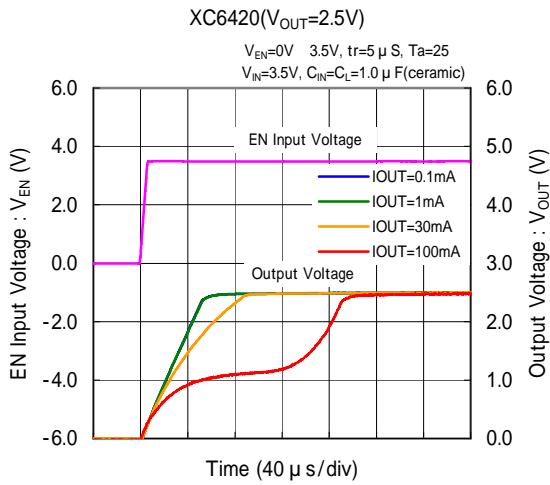

### (12) Ripple Rejection

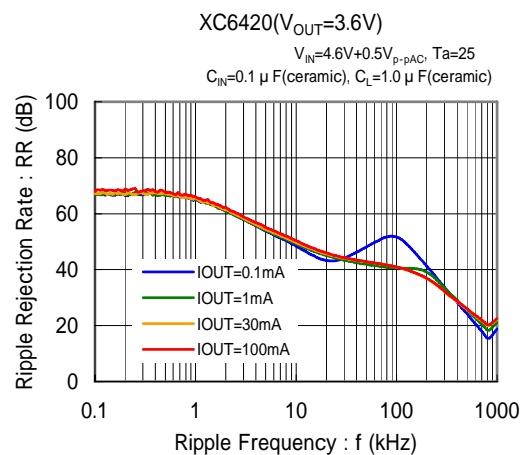
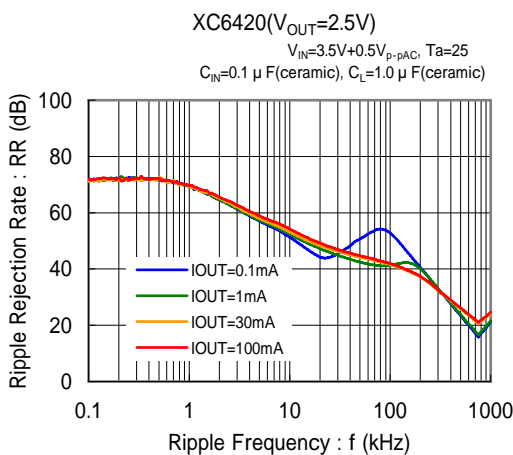
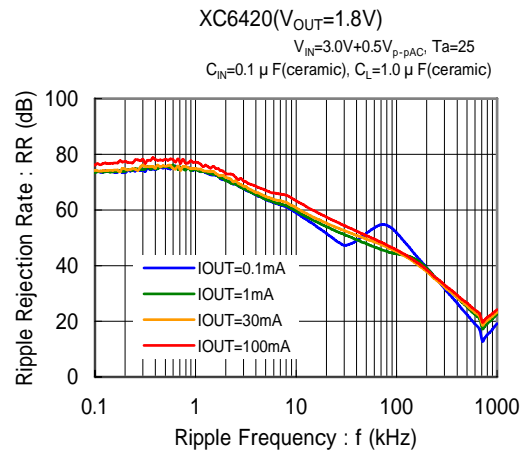
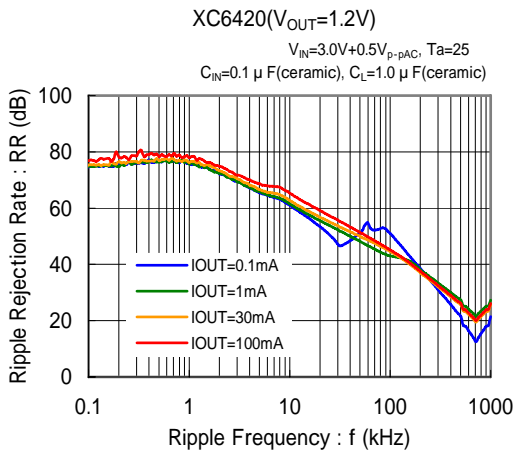

## TYPICAL PERFORMANCE CHARACTERISTICS (Continued)

### (13) Cross Talk

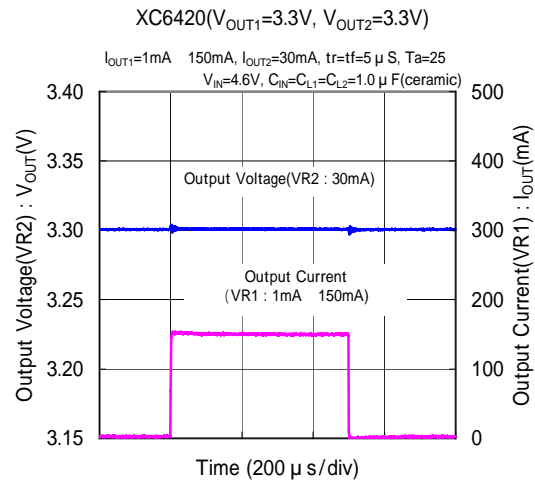
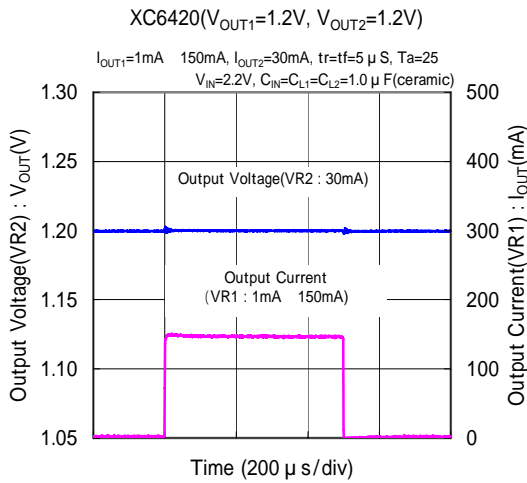

### (14) Output Noise Density

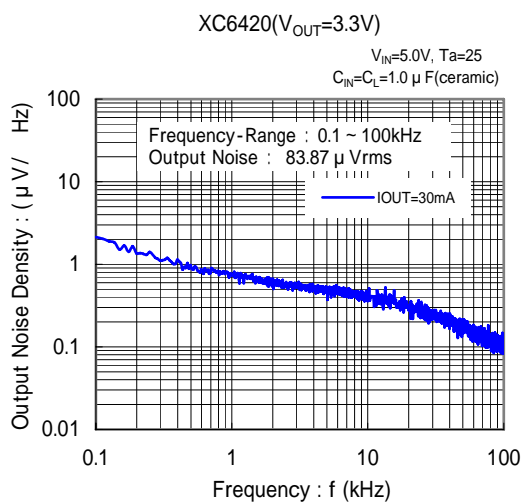
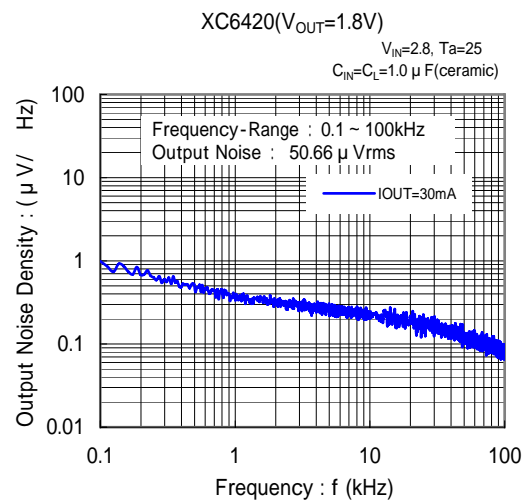
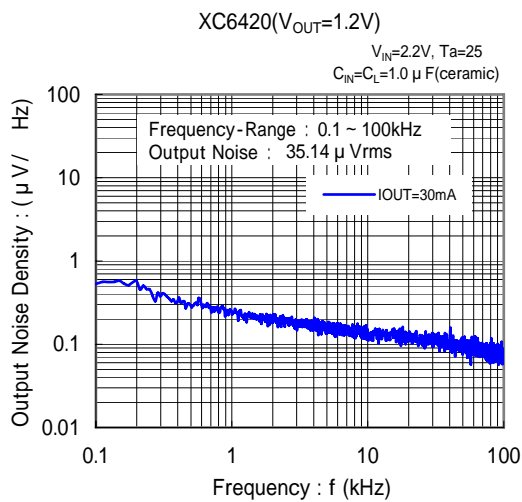

## PACKAGING INFORMATION

SOT-26

(unit : mm)

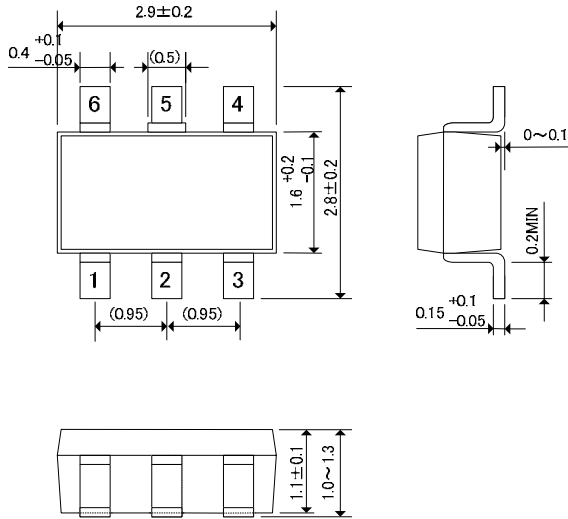

USPN-6

(unit : mm)

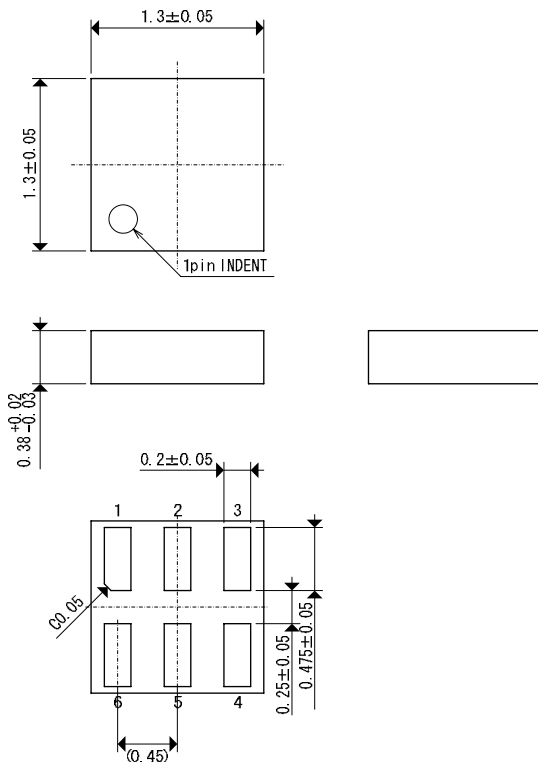

USPN-6 Reference Pattern Layout

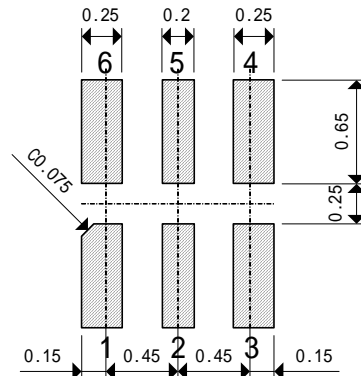

USPN-6 Reference Metal Mask Design

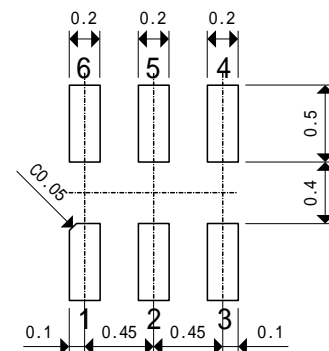

# PACKAGING INFORMATION (Continued)

USP-6B04

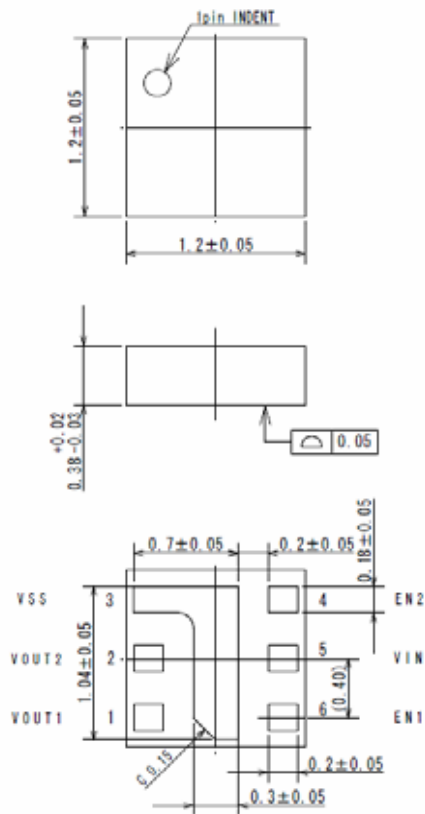

USP-6B04 Reference Pattern Layout

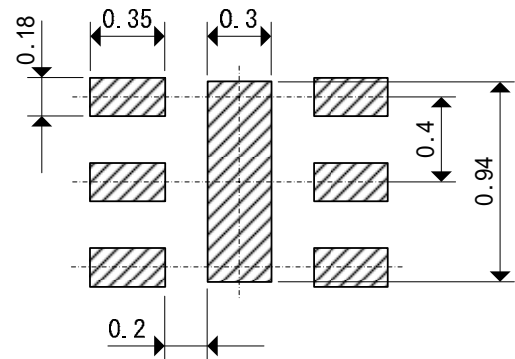

USP-6B04 Reference Metal Mask Design

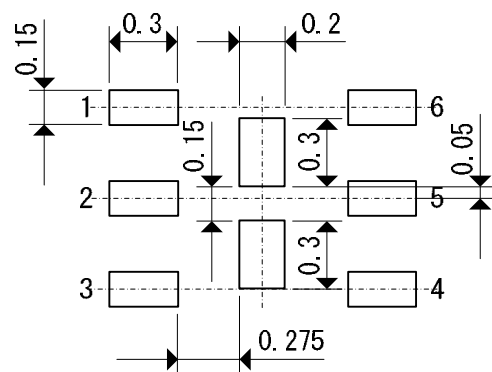

## PACKAGING INFORMATION (Continued)

### SOT-26 Power Dissipation

Power dissipation data for the SOT-26 is shown in this page.  
 The value of power dissipation varies with the mount board conditions.  
 Please use this data as the reference data taken in the following condition.

#### 1. Measurement Condition

- Condition: Mount on a board
- Ambient: Natural convection
- Soldering: Lead (Pb) free
- Board: Dimensions 40 x 40 mm (1600 mm<sup>2</sup> in one side)  
 Copper (Cu) traces occupy 50% of the board area  
 In top and back faces  
 Package heat-sink is tied to the copper traces
- Material: Glass Epoxy (FR-4)
- Thickness: 1.6 mm
- Through-hole: 4 x 0.8 Diameter

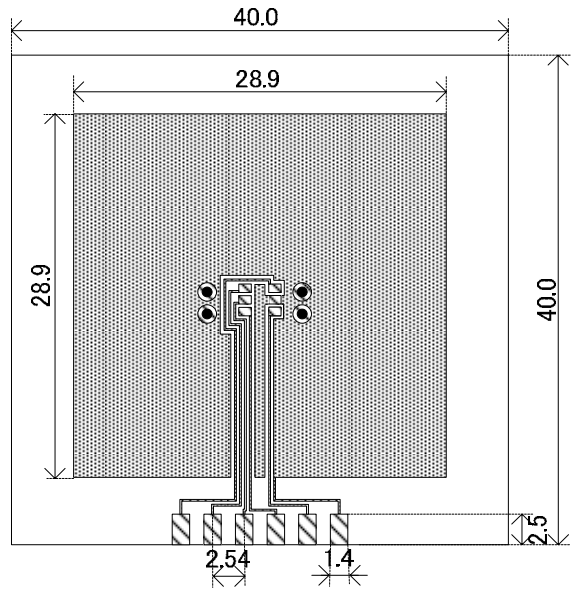

Evaluation Board (Unit: mm)

#### 2. Power Dissipation vs. Ambient Temperature

Board Mount ( $T_j \text{ max} = 125$  )

Ambient Temperature ( )	Power Dissipation Pd (mW)	Thermal Resistance ( /W)
25	600	166.67
85	240	

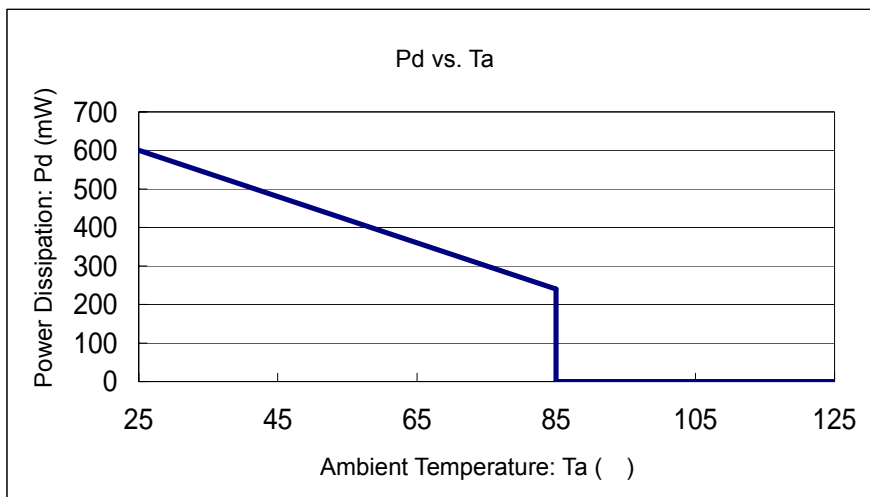

## PACKAGING INFORMATION (Continued)

### USPN-6 Power Dissipation

Power dissipation data for the USPN-6 is shown in this page.

The value of power dissipation varies with the mount board conditions.

Please use this data as the reference data taken in the following condition..

#### 1. Measurement Condition

Condition: Mount on a board

Ambient: Natural convection

Soldering: Lead (Pb) free

Board: 40 x 40 mm (1600 mm<sup>2</sup>)

4 Copper Layers

Each layer is connected to the package heat-sink and terminal pin No.1.

Each layer has approximately 800mm<sup>2</sup> copper area.

Material: Glass Epoxy (FR-4)

Thickness: 1.6 mm

Through-hole: 4 x 0.8 Diameter

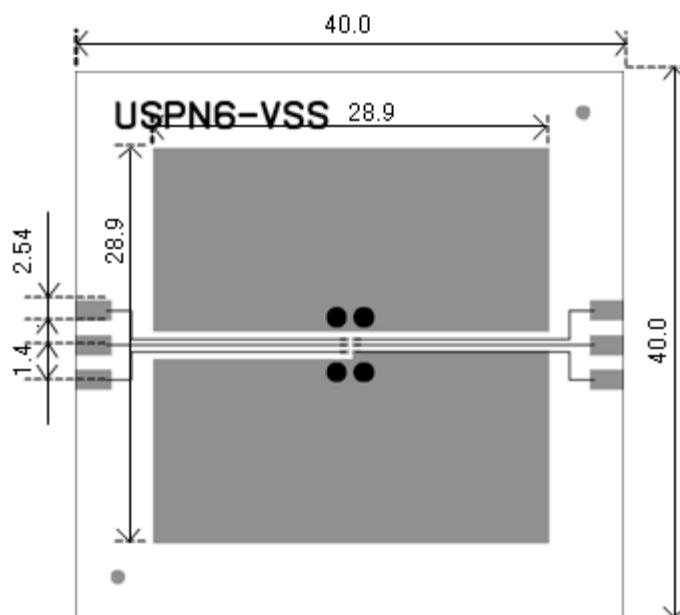

Evaluation Board (Unit: mm)

#### 2. Power Dissipation vs. Ambient Temperature

Board Mount ( $T_j \text{ max} = 125$  )

Ambient Temperature ( )	Power Dissipation Pd (mW)	Thermal Resistance ( /W)
25	600	166.67
85	240	

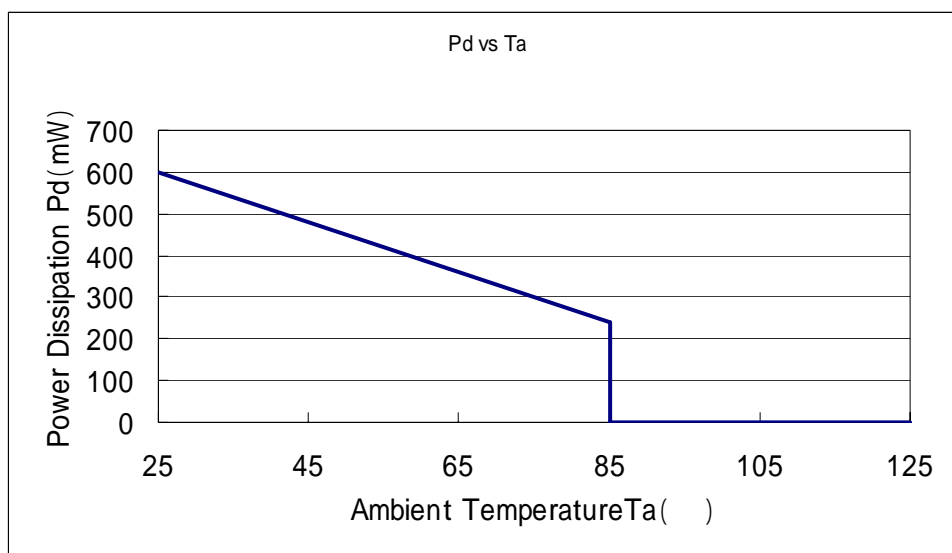

## PACKAGING INFORMATION (Continued)

### USP-6B04 Power Dissipation

Power dissipation data for the USP-6B04 is shown in this page.  
 The value of power dissipation varies with the mount board conditions.  
 Please use this data as the reference data taken in the following condition.

#### 1. Measurement Condition

- Condition: Mount on a board
- Ambient: Natural convection
- Soldering: Lead (Pb) free
- Board Dimensions: 40mm×40mm ( 1600mm<sup>2</sup> in one side )
  - 1st Inner Metal Layer about 50%
  - 2nd Inner Metal Layer about 50%
  - 3rd Inner Metal Layer about 50%
  - 4th Inner Metal Layer about 50%
  - Each heat sink back metal is connected to the Inner layers respectively.
- Material: Glass Epoxy (FR-4)
- Thickness: 1.0 mm
- Through-hole: 4 x 0.4 Diameter

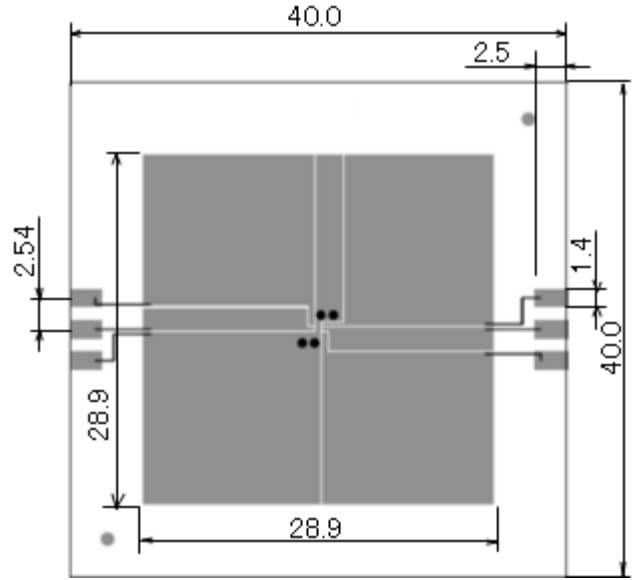

Evaluation Board (Unit: mm)

#### 2. Power Dissipation vs. Ambient Temperature

Board Mount ( $T_j \text{ max} = 125$  )

Ambient Temperature ( )	Power Dissipation Pd (mW)	Thermal Resistance ( /W)
25	600	166.67
85	240	

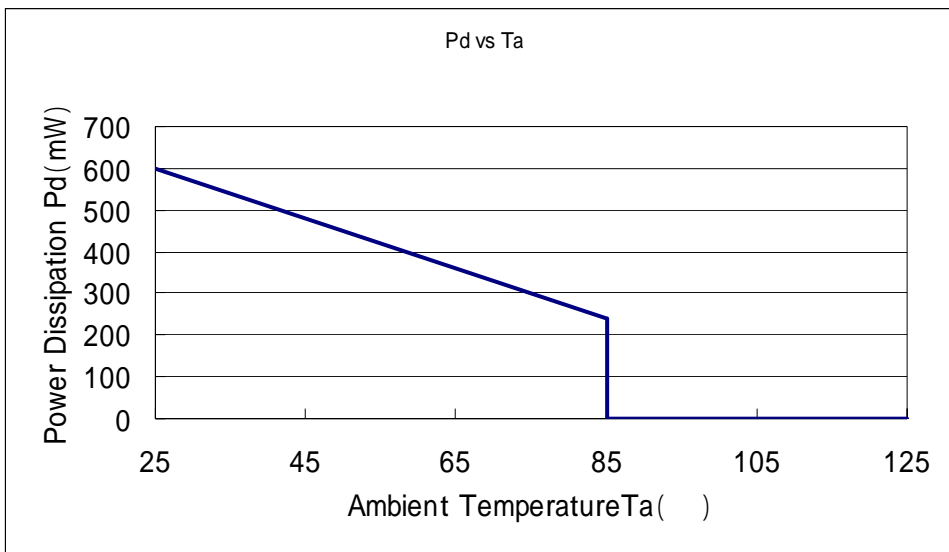



## MARKING RULE

### SOT-26

represents product series

MARK	PRODUCT SERIES
2	XC6420*****-G

represents output voltage

ex.)

MARK		PRODUCT SERIES
0	1	

represents production lot number.

01 to 09, 0A to 0Z, 11 to 9Z, A1 to A9, AA to Z9, ZA to ZZ in order.

(G, I, J, O, Q, W excepted)

\*No character inversion used.

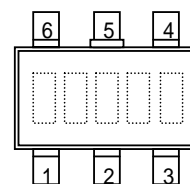

SOT-26  
(TOP VIEW)

### USPN-6/USP-6B04

represents internal sequential number

represents production lot number.

01 to 09, 0A to 0Z, 11 to 9Z, A1 to A9, AA to Z9, ZA to ZZ in order.

(G, I, J, O, Q, W excepted)

\*No character inversion used.

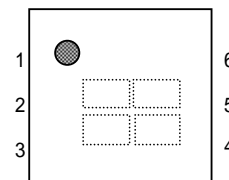

USPN-6/USP-6B04  
(TOP VIEW)

1. The products and product specifications contained herein are subject to change without notice to improve performance characteristics. Consult us, or our representatives before use, to confirm that the information in this datasheet is up to date.
2. We assume no responsibility for any infringement of patents, patent rights, or other rights arising from the use of any information and circuitry in this datasheet.
3. Please ensure suitable shipping controls (including fail-safe designs and aging protection) are in force for equipment employing products listed in this datasheet.
4. The products in this datasheet are not developed, designed, or approved for use with such equipment whose failure or malfunction can be reasonably expected to directly endanger the life of, or cause significant injury to, the user.  
(e.g. Atomic energy; aerospace; transport; combustion and associated safety equipment thereof.)
5. Please use the products listed in this datasheet within the specified ranges.  
Should you wish to use the products under conditions exceeding the specifications, please consult us or our representatives.
6. We assume no responsibility for damage or loss due to abnormal use.
7. All rights reserved. No part of this datasheet may be copied or reproduced without the prior permission of TOREX SEMICONDUCTOR LTD.

**TOREX SEMICONDUCTOR LTD.**